

Marameter

Families 844 K and 844 D

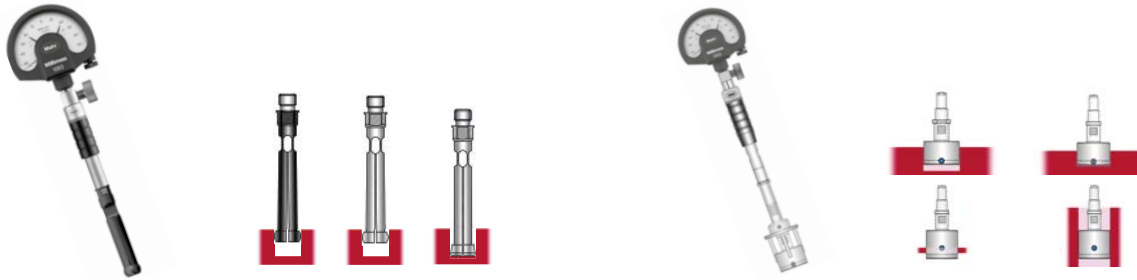

Marameter Indicating Bore Gages 09/2021

Self-centering bore gages and accessories

- 844 K Inside measuring probes determine diameter by finding reversal point.
- 844 D Indicating plug gages determine diameter values reliably, precisely and directly.

Marameter

Indicating Bore Gages



Marameter | Self-centering inner measuring device 844 K

Indicating bore measurement in high precision



Marameter | Modular System

Overview Marameter 844 K **4**

Marameter 844 KC, Sets in case with DLC coating **6**

Marameter 844 K, Sets in case, standard design **8**

Marameter 844 KS, Sets in case for blind hole measuring **10**

Marameter 844 KM, Measuring stand and accessories **12**

Marameter 844 KCK / 844 Kk / 844 KSk – Inside probes single **14**

Overview Modular System **20**

Marameter 844 Kg / 844 Kga / 844 Kgz – Holders **21**

Marameter 844 Kv – Extensions for measuring depth **22**

Marameter 844 Kw – Angle attachment 90° **23**

Marameter 844 Ke – Setting rings **24**

Marameter | Indicating Bore Gages 844 D

Indicating bore gages for highest precision

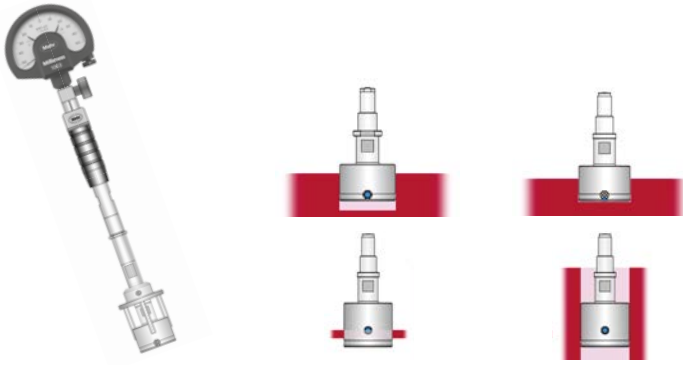

Overview Marameter 844 D	26
Marameter 844 D – Standard model	28
Marameter 844 DR – For through holes and narrow parts	29
Marameter 844 DS – For blind holes	30
Marameter Variants	
844 D-C / 844 DR-C / 844 DS-C – Measuring surfaces hard chrome-plated	31
844 D-R / 844 DR-R / 844 DS-R – Measuring surfaces ruby-tipped	34
844 D-D / 844 DR-D – Measuring surfaces diamond-tipped	37
844 D-FD / 844 DR-FD – Measuring contacts with customer-specified location “e”	39
844 D-M / 844 DR-M / 844 DS-M – With extended measuring range	41
844 D-HR / 844 DR-HR / 844 DS-HR High Resolution - For very tight tolerance fields less than 10 µm	44
844 DS-F – Only with front chamfer, for measuring very short bores	47
844 D-3 / 844 DR-3 – With 3-point detecting (3 x 120°)	48
Modular Elements	
Marameter 844 Dgk / 844 Dga / 844 Dg / 844 Dg-XL – Plug gage holders	50
Marameter 844 Dge – Plug gage holders for inductive probe	51
Marameter 844 Dv – Extensions for measuring depth	52
Marameter 844 Dw – Angle attachments 90°	53
Marameter 844 Dt-xx – Depth stops	54

Marameter | Self-centering inner measuring device 844 K

High-precision comparative measurements of holes

Inside measuring probes from the 844 K family are 2-point comparative measuring instruments used to determine a reversing point in a bore by oscillation. This reversal point equates to the minimum and thus the exact bore diameter.

Measuring process

The measuring value is displayed with analog dial comparators or electronic dial indicators.

Practical tip

An electronic dial indicator such as type 1087 BR or 1087 BRi, offers the major advantage of being able to automatically record the reversing point using the MIN function and display an absolute measuring value on the screen thanks to the PRESET setting. In addition, you can conveniently and reliably transfer the measuring data to a PC or a CAQ system by data cable or Integrated Wireless technology.

Setting the comparative measuring instrument

Setting rings are used to set the instrument to the respective nominal size.

Typical applications of self-centering inside measuring probes

- Rapid testing of hole diameters

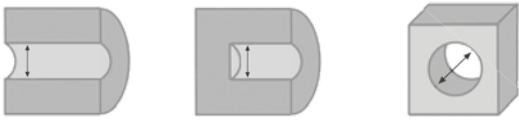

- Determining roundness and cylindricity deviations by rotating and moving to other bore depths



Special advantages

Setting rings are used to set the instrument to the respective nominal size.

- Self-centering in the hole
- Fast determination of reversing point by oscillation
- Measuring value displayed immediately
- Ideal for processing measuring values directly especially when used with digital indicating instruments

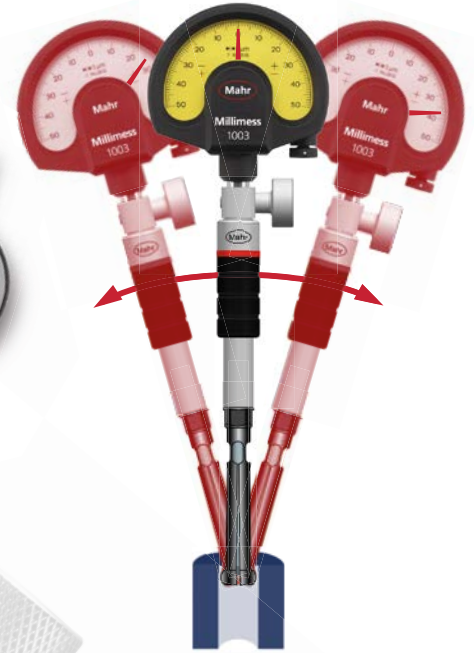

Measuring process

The reversing point (minimum value) is calculated by rocking in a bore



Marameter | Self-centering inner measuring device 844 K

Inside measuring probe models (split-ball probe)

844 K Standard for common hole shapes

- Split-ball probe made of hardened steel
- Hard chrome-plated measuring surfaces

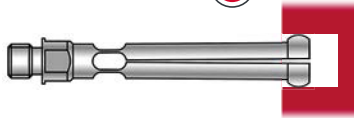

844 KC for common hole shapes with DLC coating

- Split-ball probe made of hardened steel
- Measuring surfaces and inner edges coated with DLC (hard diamond-like coating)
- Enhanced wear protection and very low friction coefficients, therefore
- ideal for measurements on sensitive or abrasive surfaces
- For common hole shapes

844 KS split-ball probe for bore measurements close to the bottom of the hole

- Split-ball probe made of hardened steel
- Hard chrome plated measuring surfaces

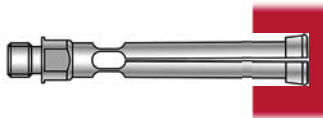

Particular advantages of DLC coating

- **DLC coating** (diamond-like carbon)
- Extremely hard coating for **very high wear resistance**
- **Extremely low friction coefficient, thus preventing** e.g.
 - Streaking on precision-machined non-ferrous metal surfaces
 - Increased wear on abrasive materials
- DLC coating over entire measuring surfaces including inner contact point of driving needle, for **very high long-term accuracy (Linearity)**
- **Visual wear display:** Visible light spot once coating is worn
- **Excellent corrosion prevention**

Ideal equipment for long-term accuracy

Driving needles are inserted in the probe to transfer the measuring movement of the probe head to the indicating instrument. To ensure **maximum service life** and thus



Modular system

When combined with extensive accessories (indicating instruments, inside measuring probes with driving needle, holders, extensions and right-angle attachments), inside measuring probes become precision measuring instruments customized to the measuring task.

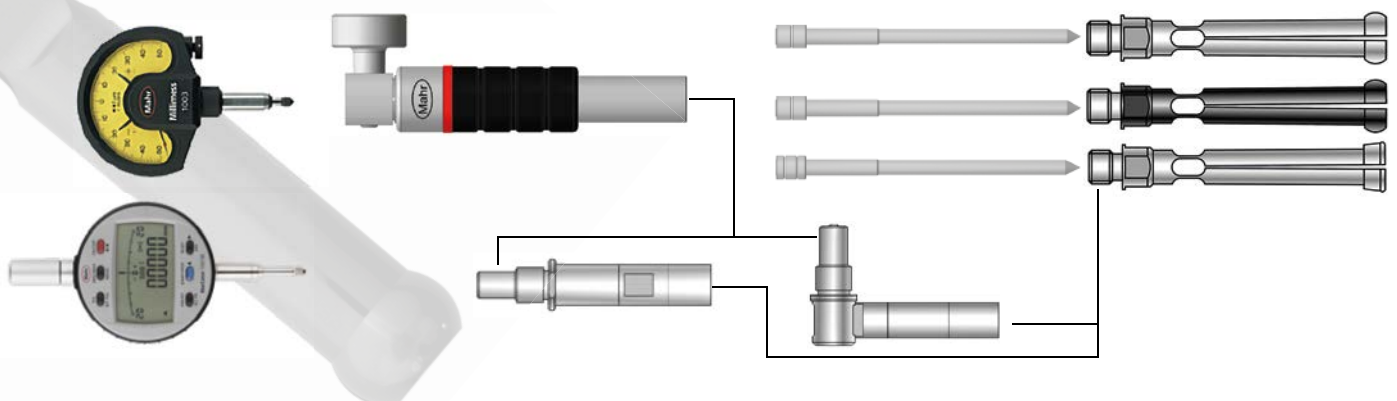

Marameter 844 KC

Self-centering dial bore gage

FEATURES

- Measuring head made in harden steel, DLC-coated
- Constant measuring force as a result of built-in spring, eliminating user influence
- Extensive modular system is composed of measuring head, transfer needle, holder, depth extension, right angle attachments and setting rings



Application: Standard model with DLC-coated surface

- For indicating measurement of diameter and testing for roundness and conicity of bores
- Especially suitable for testing batches
- Determine the reversal point by rocking in the bore



- **Benefits of DLC Coating**
 - Explanation DLC = Diamond-Like Carbon
 - Extremely high wear resistance, for long service life even on hard or abrasive surfaces
 - Reduction of friction, ideal for sensitive surfaces such as non-ferrous metals and aluminium alloys
 - Wear indicator, worn areas appear as bright spots in the dark DLC coating

- **The minimum set of a measuring instrument consists of:** Measuring head, transfer needle and holder plus indicator unit

- **Package contains:** Measuring holder 844 Kg, probe, expanding pin, wooden case, excludes indicator

TECHNICAL DATA

Order no.	Type	Nominal size	Individual probe measuring range	Number of measuring probes	Linearity deviation f_e	Repeatability f_w					
		mm	mm	Piece		μm					
4473105	844 KC	1,00	0,95 – 1,15	5	2 %, min. 1 μm	1					
		1,10	1,07 – 1,25								
		1,20	1,17 – 1,35								
		1,30	1,27 – 1,45								
		1,40	1,37 – 1,55								
4473106	844 KC	1,75	1,50 – 1,90	9	1 %, min. 1 μm	1					
		2,00	1,80 – 2,20								
		2,25	2,05 – 2,45								
		2,50	2,30 – 2,70								
		2,75	2,55 – 2,95								
		3,00	2,80 – 3,20								
		3,25	3,05 – 3,45								
		3,50	3,30 – 3,70								
		3,75	3,55 – 3,95								
4473107	844 KC	4,00	3,70 – 4,30	12	1 %, min. 1 μm	1					
		4,50	4,20 – 4,80								
		5,00	4,70 – 5,30								
		5,50	5,20 – 5,80								
		6,00	5,70 – 6,30								
		6,50	6,20 – 6,80								
		7,00	6,70 – 7,30								
		7,50	7,20 – 7,80								
		8,00	7,70 – 8,30								
		8,50	8,20 – 8,80								
		9,00	8,70 – 9,30								
		9,50	9,20 – 9,80								
		4473108	844 KC				1,75	1,50 – 1,90	21	1 %, min. 1 μm	1
							2,00	1,80 – 2,20			
2,25	2,05 – 2,45										
2,50	2,30 – 2,70										
2,75	2,55 – 2,95										
3,00	2,80 – 3,20										
3,25	3,05 – 3,45										
3,50	3,30 – 3,70										
3,75	3,55 – 3,95										
4,00	3,70 – 4,30										
4,50	4,20 – 4,80										
5,00	4,70 – 5,30										
5,50	5,20 – 5,80										
6,00	5,70 – 6,30										
6,50	6,20 – 6,80										
7,00	6,70 – 7,30										
7,50	7,20 – 7,80										
8,00	7,70 – 8,30										
8,50	8,20 – 8,80										
9,00	8,70 – 9,30										
9,50	9,20 – 9,80										
4473109	844 KC	10,00	9,40 – 10,60	11	1 %, min. 1 μm	1					
		11,00	10,40 – 11,60								
		12,00	11,40 – 12,60								
		13,00	12,40 – 13,60								
		14,00	13,40 – 14,60								
		15,00	14,40 – 15,60								
		16,00	15,40 – 16,60								
		17,00	16,40 – 17,60								
		18,00	17,40 – 18,60								
		19,00	18,40 – 19,60								
		20,00	19,40 – 20,60								

Marameter 844 KC

Self-centering dial bore gage

Order no.	Nominal size mm	H1 mm	L mm	Measuring depth mm	Order no.	Nominal size mm	H1 mm	L mm	Measuring depth mm
4473005	1,00	0,6	19,50	10,5	4473008	1,75	0,9	25,30	16
	1,10	0,6	19,50	10,5		2,00	0,9	25,30	16
	1,20	0,6	19,50	10,5		2,25	0,9	25,30	16
	1,30	0,6	19,50	10,5		2,50	1,2	30,60	21
	1,40	0,6	19,50	10,5		2,75	1,2	30,60	21
4473006	1,75	0,9	25,30	16		3,00	1,2	30,60	21
	2,00	0,9	25,30	16		3,25	1,2	30,60	21
	2,25	0,9	25,30	16		3,50	1,2	30,60	21
	2,50	1,2	30,60	21		3,75	1,2	30,60	21
	2,75	1,2	30,60	21		4,00	2,0	47,30	38
	3,00	1,2	30,60	21		4,50	2,0	47,30	38
	3,25	1,2	30,60	21		5,00	2,0	47,30	38
	3,50	1,2	30,60	21		5,50	2,0	47,30	38
3,75	1,2	30,60	21	6,00		2,0	47,30	38	
4473007	4,00	2,0	47,30	38		6,50	2,0	47,30	38
	4,50	2,0	47,30	38	7,00	2,0	47,30	38	
	5,00	2,0	47,30	38	7,50	2,0	47,30	38	
	5,50	2,0	47,30	38	8,00	2,0	47,30	38	
	6,00	2,0	47,30	38	8,50	2,0	47,30	38	
	6,50	2,0	47,30	38	9,00	2,0	47,30	38	
	7,00	2,0	47,30	38	9,50	2,0	47,30	38	
	7,50	2,0	47,30	38	4473009	10,00	3,3	48,50	45
	8,00	2,0	47,30	38		11,00	3,3	48,50	45
	8,50	2,0	47,30	38		12,00	3,3	48,50	45
	9,00	2,0	47,30	38		13,00	3,3	48,50	45
9,50	2,0	47,30	38	14,00		3,3	48,50	45	
				15,00		3,3	48,50	45	
				16,00		3,3	48,50	45	
				17,00	3,3	48,50	45		
				18,00	3,3	48,50	45		
				19,00	3,3	48,50	45		
				20,00	3,3	48,50	45		

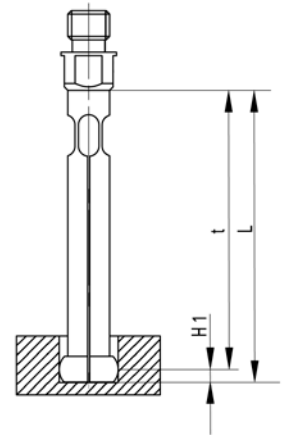

ACCESSORIES

Order no.	Description	Type
4333000	Millimess 5 μm , $\pm 130 \mu\text{m}$	1004
4334000	Millimess 1 μm , $\pm 50 \mu\text{m}$	1003
4335000	Millimess 0,5 μm , $\pm 25 \mu\text{m}$	1002
4337662	Digital indicator, 0,0005 mm, 12,5 mm	1087 BR
4337664	Digital indicator, 0,0005 mm, 12,5 mm	1087 BRi
4473375	844 Ke Setting rings in Set for measuring range 1 –1,4 mm	844 Ke
4473400	844 Kg Holder for indicator, $\varnothing 8 \text{ mm}$ / M6 x 0.75	844 Kg
4473401	844 Kga Holder for indicator, $\varnothing 8 \text{ mm}$ / M6 x 0.75	844 Kga
4473402	844 Kgz Holder for indicator, $\varnothing .375''$ / M6 x 0.75	844 Kgz
4473405	844 Kv Extension for measuring depth, length 50 mm	844 Kv
4473406	844 Kv Extension for measuring depth, length 100 mm	844 Kv
4473407	844 Kv Extension for measuring depth, length 250 mm	844 Kv
4473409	844 Kw Angle attachment 90°, M6 x 0.75	844 Kw
4473376	844 Ke Setting rings in Set for measuring range 1,75 –3,75 mm	844 Ke
4473377	844 Ke Setting rings in Set for measuring range 4 –9,5 mm	844 Ke
4473378	844 Ke Setting rings in Set for measuring range 1,75 –9,5 mm	844 Ke
4473379	844 Ke Setting rings in Set for measuring range 10 –20 mm	844 Ke

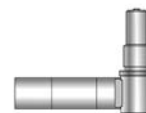

Marameter 844 K

Self-centering dial bore gage

FEATURES

- Measuring head made of hardened steel, hard chrome plated
- Constant measuring force as a result of built-in spring, eliminating user influence
- Extensive modular system is composed of measuring head, transfer needle, holder, depth extension, right angle attachments and setting rings
- The minimum set of a measuring instrument consists of: Measuring head, transfer needle and holder plus indicator unit
- Package contains: Measuring holder 844 Kg, probe, expanding pin, wooden case, excludes indicator



Application: Standard model

- For indicating measurement of diameter and testing for roundness and conicity of bores
- Especially suitable for testing batches
- Determine the reversal point by rocking in the bore

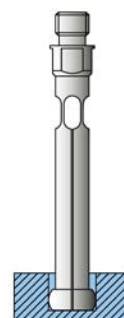

TECHNICAL DATA

Order no.	Type	Nominal size	Individual probe measuring range	Number of measuring probes	Linearity deviation f_e	Repeatability f_w
		mm	mm	Piece		μm
4473005	844 K	1,00	0,95 - 1,15	5	2 %, min. 1 μm	1
		1,10	1,07 - 1,25			
		1,20	1,17 - 1,35			
		1,30	1,27 - 1,45			
		1,40	1,37 - 1,55			
4473006	844 K	1,75	1,50 - 1,90	9	1 %, min. 1 μm	1
		2,00	1,80 - 2,20			
		2,25	2,05 - 2,45			
		2,50	2,30 - 2,70			
		2,75	2,55 - 2,95			
		3,00	2,80 - 3,20			
		3,25	3,05 - 3,45			
		3,50	3,30 - 3,70			
		3,75	3,55 - 3,95			
4473007	844 K	4,00	3,70 - 4,30	12	1 %, min. 1 μm	1
		4,50	4,20 - 4,80			
		5,00	4,70 - 5,30			
		5,50	5,20 - 5,80			
		6,00	5,70 - 6,30			
		6,50	6,20 - 6,80			
		7,00	6,70 - 7,30			
		7,50	7,20 - 7,80			
		8,00	7,70 - 8,30			
		8,50	8,20 - 8,80			
		9,00	8,70 - 9,30			
		9,50	9,20 - 9,80			
		4473008	844 K			
2,00	1,80 - 2,20					
2,25	2,05 - 2,45					
2,50	2,30 - 2,70					
2,75	2,55 - 2,95					
3,00	2,80 - 3,20					
3,25	3,05 - 3,45					
3,50	3,30 - 3,70					
3,75	3,55 - 3,95					
4,00	3,70 - 4,30					
4,50	4,20 - 4,80					
5,00	4,70 - 5,30					
5,50	5,20 - 5,80					
6,00	5,70 - 6,30					
6,50	6,20 - 6,80					
7,00	6,70 - 7,30					
7,50	7,20 - 7,80					
8,00	7,70 - 8,30					
8,50	8,20 - 8,80					
9,00	8,70 - 9,30					
9,50	9,20 - 9,80					
4473009	844 K	10,00	9,40 - 10,60	11	1 %, min. 1 μm	1
		11,00	10,40 - 11,60			
		12,00	11,40 - 12,60			
		13,00	12,40 - 13,60			
		14,00	13,40 - 14,60			
		15,00	14,40 - 15,60			
		16,00	15,40 - 16,60			
		17,00	16,40 - 17,60			
		18,00	17,40 - 18,60			
		19,00	18,40 - 19,60			
		20,00	19,40 - 20,60			

Marameter 844 K

Self-centering dial bore gage

Order no.	Nominal size mm	H1 mm	L mm	Measuring depth mm	Order no.	Nominal size mm	H1 mm	L mm	Measuring depth mm
4473005	1,00	0,6	19,50	10,5	4473008	1,75	0,9	25,30	16
	1,10	0,6	19,50	10,5		2,00	0,9	25,30	16
	1,20	0,6	19,50	10,5		2,25	0,9	25,30	16
	1,30	0,6	19,50	10,5		2,50	1,2	30,60	21
	1,40	0,6	19,50	10,5		2,75	1,2	30,60	21
4473006	1,75	0,9	25,30	16		3,00	1,2	30,60	21
	2,00	0,9	25,30	16		3,25	1,2	30,60	21
	2,25	0,9	25,30	16		3,50	1,2	30,60	21
	2,50	1,2	30,60	21		3,75	1,2	30,60	21
	2,75	1,2	30,60	21		4,00	2,0	47,30	38
	3,00	1,2	30,60	21		4,50	2,0	47,30	38
	3,25	1,2	30,60	21		5,00	2,0	47,30	38
	3,50	1,2	30,60	21		5,50	2,0	47,30	38
3,75	1,2	30,60	21	6,00		2,0	47,30	38	
4473007	4,00	2,0	47,30	38		6,50	2,0	47,30	38
	4,50	2,0	47,30	38	7,00	2,0	47,30	38	
	5,00	2,0	47,30	38	7,50	2,0	47,30	38	
	5,50	2,0	47,30	38	8,00	2,0	47,30	38	
	6,00	2,0	47,30	38	8,50	2,0	47,30	38	
	6,50	2,0	47,30	38	9,00	2,0	47,30	38	
	7,00	2,0	47,30	38	9,50	2,0	47,30	38	
	7,50	2,0	47,30	38	4473009	10,00	3,3	48,50	45
	8,00	2,0	47,30	38		11,00	3,3	48,50	45
	8,50	2,0	47,30	38		12,00	3,3	48,50	45
	9,00	2,0	47,30	38		13,00	3,3	48,50	45
9,50	2,0	47,30	38	14,00		3,3	48,50	45	
				15,00		3,3	48,50	45	
				16,00		3,3	48,50	45	
				17,00	3,3	48,50	45		
				18,00	3,3	48,50	45		
				19,00	3,3	48,50	45		
				20,00	3,3	48,50	45		

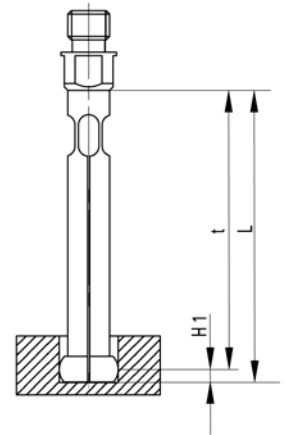

ACCESSORIES

Order no.	Description	Type
4333000	Millimess 5 μm , $\pm 130 \mu\text{m}$	1004
4334000	Millimess 1 μm , $\pm 50 \mu\text{m}$	1003
4335000	Millimess 0,5 μm , $\pm 25 \mu\text{m}$	1002
4337662	Digital indicator, 0,0005 mm, 12,5 mm	1087 BR
4337664	Digital indicator, 0,0005 mm, 12,5 mm	1087 BRi
4473375	844 Ke Setting rings in Set for measuring range 1 –1,4 mm	844 Ke
4473400	844 Kg Holder for indicator, $\varnothing 8 \text{ mm}$ / M6 x 0.75	844 Kg
4473401	844 Kga Holder for indicator, $\varnothing 8 \text{ mm}$ / M6 x 0.75	844 Kga
4473402	844 Kgz Holder for indicator, $\varnothing .375''$ / M6 x 0.75	844 Kgz
4473405	844 Kv Extension for measuring depth, length 50 mm	844 Kv
4473406	844 Kv Extension for measuring depth, length 100 mm	844 Kv
4473407	844 Kv Extension for measuring depth, length 250 mm	844 Kv
4473409	844 Kw Angle attachment 90°, M6 x 0.75	844 Kw
4473376	844 Ke Setting rings in Set for measuring range 1,75 –3,75 mm	844 Ke
4473377	844 Ke Setting rings in Set for measuring range 4 –9,5 mm	844 Ke
4473378	844 Ke Setting rings in Set for measuring range 1,75 –9,5 mm	844 Ke
4473379	844 Ke Setting rings in Set for measuring range 10 –20 mm	844 Ke



Marameter 844 KS

Self-centering dial bore gage

FEATURES

- Measuring head made of hardened steel, hard chrome plated
- Constant measuring force as a result of built-in spring, eliminating user influence
- Extensive modular system is composed of measuring head, transfer needle, holder, depth extension, right angle attachments and setting rings

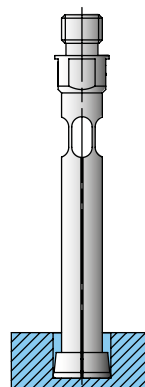

- The minimum set of a measuring instrument consists of: Measuring head, transfer needle and holder plus indicator unit

Package contains: Measuring holder 844 Kg, probe, expanding pin, wooden case, excludes indicator

Application:

Model for Blind Holes

- For measurements near to the bottom of bores
- For indicating measurement of diameter and testing for roundness and conicity of bores
- Especially suitable for testing batches
- Determine the reversal point by rocking in the bore

TECHNICAL DATA

Order no.	Type	Nominal size	Individual probe measuring range	Number of measuring probes	Linearity deviation f_e	Repeatability f_w
		mm	mm	Piece		μm
4473207	844 KS	4,00	3,70 – 4,30	12	1 %, min. 1 μm	1
		4,50	4,20 – 4,80			
		5,00	4,70 – 5,30			
		5,50	5,20 – 5,80			
		6,00	5,70 – 6,30			
		6,50	6,20 – 6,80			
		7,00	6,70 – 7,30			
		7,50	7,20 – 7,80			
		8,00	7,70 – 8,30			
		8,50	8,20 – 8,80			
		9,00	8,70 – 9,30			
		9,50	9,20 – 9,80			
4473209	844 KS	10,00	9,40 – 10,60	11	1 %, min. 1 μm	1
		11,00	10,40 – 11,60			
		12,00	11,40 – 12,60			
		13,00	12,40 – 13,60			
		14,00	13,40 – 14,60			
		15,00	14,40 – 15,60			
		16,00	15,40 – 16,60			
		17,00	16,40 – 17,60			
		18,00	17,40 – 18,60			
		19,00	18,40 – 19,60			
		20,00	19,40 – 20,60			

Marameter 844 KS

Self-centering dial bore gage

Order no.	Nominal size mm	H1 mm	L mm	Measuring depth mm
4473207	4,00	0,5	47,30	38
	4,50	0,5	47,30	38
	5,00	0,5	47,30	38
	5,50	0,5	47,30	38
	6,00	0,5	47,30	38
	6,50	0,5	47,30	38
	7,00	0,5	47,30	38
	7,50	0,5	47,30 <td 38	
	8,00	0,5	47,30	38
	8,50	1,0	48,50	45
	9,00	1,0	48,50	45
9,50	1,0	48,50	45	
4473209	10,00	1,0	48,50	45
	11,00	1,0	48,50	45
	12,00	1,0	48,50	45
	13,00	1,0	48,50	45
	14,00	1,0	48,50	45
	15,00	1,0	48,50	45
	16,00	1,0	48,50	45
	17,00	1,0	48,50	45
	18,00	1,0	48,50	45
	19,00	1,0	48,50	45
	20,00	1,0	48,50	45

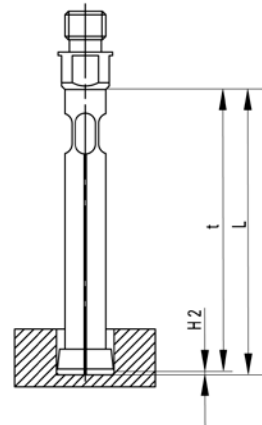

ACCESSORIES

Order no.	Description	Type
4333000	Millimess 5 μm , \pm 130 μm	1004
4334000	Millimess 1 μm , \pm 50 μm	1003
4335000	Millimess 0,5 μm , \pm 25 μm	1002
4337662	Digital indicator, 0,0005 mm, 12,5 mm	1087 BR
4337664	Digital indicator, 0,0005 mm, 12,5 mm	1087 BRi
4473400	844 Kg Holder for indicator, \varnothing 8 mm / M6 x 0.75	844 Kg
4473401	844 Kga Holder for indicator, \varnothing 8 mm / M6 x 0.75	844 Kga
4473402	844 Kgz Holder for indicator, \varnothing .375" / M6 x 0.75	844 Kgz
4473405	844 Kv Extension for measuring depth, length 50 mm	844 Kv
4473406	844 Kv Extension for measuring depth, length 100 mm	844 Kv
4473407	844 Kv Extension for measuring depth, length 250 mm	844 Kv
4473409	844 Kw Angle attachment 90°, M6 x 0.75	844 Kw
4473377	844 Ke Setting rings in Set for measuring range 4 –9,5 mm	844 Ke
4473379	844 Ke Setting rings in Set for measuring range 10 –20 mm	844 Ke



Marameter 844 KM

Measuring stand

FEATURES

Measuring stand with practical equipment:

- High measuring column with large adjustment range
- Stop ring for measuring height, ideal when changing probes
- Large stroke for probe lowering
- Depth stop for stroke limitation
- Large measuring table (Ø 120 mm) with dust grooves and 4 threaded holes for the individual mounting of a prismatic stop 844 KMp
- Adjustment element for device holder 844 Kg / 844 Kga / 844 Kgz with shaft Ø 10 mm
- Additional mounting Ø 8 mm for optional dial gage as measuring depth indicator.



Application:

Ideal for production testing with 844 Kxx inside measuring probes, eliminates need for rocking to find reversal point

TECHNICAL DATA

Order no.	Throat depth	Stroke	Max. object height	Table diameter	Type
4473420	mm 90	mm 50	mm approx. 150 mm	120	844 KM

Marameter 844 KM

Measuring stand

ACCESSORIES

Order no.	Description	Type
4473425	Floating holder for measuring stand 844 KM, incl. 2 bushings to clamp shaft \varnothing 10 mm and \varnothing 11,9 mm	844 KM _s
4473426	Prismatic stop incl. knurled clamping screw for measuring table 844 KM	844 KM _p



844 KM_s

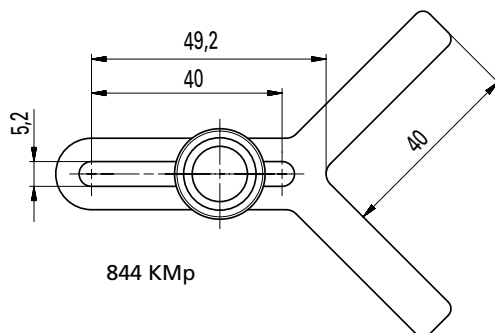
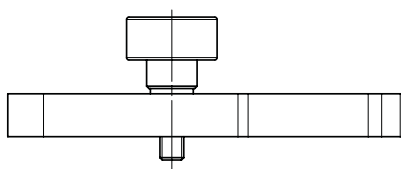

844 KM_p

Marameter 844 KCK

Inside measuring probe

FEATURES

- Measuring head made in harden steel, DLC-coated
- Constant measuring force as a result of built-in spring, eliminating user influence
- Extensive modular system is composed of measuring head, transfer needle, holder, depth extension, right angle attachments and setting rings

• Benefits of DLC Coating

- Explanation DLC = Diamond-Like Carbon
- Extremely high wear resistance, for long service life even on hard or abrasive surfaces
- Reduction of friction, ideal for sensitive surfaces such as non-ferrous metals and aluminium alloys
- Wear indicator, worn areas appear as bright spots in the dark DLC coating

- The minimum set of a measuring instrument consists of: Measuring head, transfer needle and holder plus indicator unit

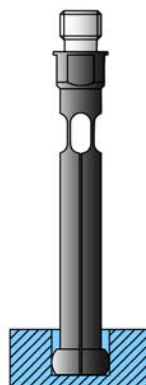

Application:

Standard form with extremely wear resistant DLC-coated surface, ideal also for scratch-sensitive surfaces

- For indicating measurement of diameter and testing for roundness and conicity of bores
- Especially suitable for testing batches
- Determine the reversal point by rocking in the bore

TECHNICAL DATA

Order no.	Type	Nominal size mm	Measuring range mm	Measuring depth mm	Design	Measuring surface
4473130	844 KCK	1	0,95 – 1,15 mm	10,5	for general applications	DLC-coated
4473131	844 KCK	1,1	1,07 – 1,25 mm	10,5	for general applications	DLC-coated
4473132	844 KCK	1,2	1,17 – 1,35 mm	10,5	for general applications	DLC-coated
4473133	844 KCK	1,3	1,27 – 1,45 mm	10,5	for general applications	DLC-coated
4473134	844 KCK	1,4	1,37 – 1,55 mm	10,5	for general applications	DLC-coated
4473135	844 KCK	1,75	1,5 – 1,9 mm	16	for general applications	DLC-coated
4473136	844 KCK	2	1,8 – 2,2 mm	16	for general applications	DLC-coated
4473137	844 KCK	2,25	2,05 – 2,45 mm	16	for general applications	DLC-coated
4473138	844 KCK	2,5	2,3 – 2,7 mm	21	for general applications	DLC-coated
4473139	844 KCK	2,75	2,55 – 2,95 mm	21	for general applications	DLC-coated
4473140	844 KCK	3	2,8 – 3,2 mm	21	for general applications	DLC-coated
4473141	844 KCK	3,25	3,05 – 3,45 mm	21	for general applications	DLC-coated
4473142	844 KCK	3,5	3,3 – 3,7 mm	21	for general applications	DLC-coated
4473143	844 KCK	3,75	3,55 – 3,95 mm	21	for general applications	DLC-coated
4473145	844 KCK	4	3,7 – 4,3 mm	38	for general applications	DLC-coated
4473146	844 KCK	4,5	4,2 – 4,8 mm	38	for general applications	DLC-coated
4473147	844 KCK	5	4,7 – 5,3 mm	38	for general applications	DLC-coated
4473148	844 KCK	5,5	5,2 – 5,8 mm	38	for general applications	DLC-coated
4473149	844 KCK	6	5,7 – 6,3 mm	38	for general applications	DLC-coated
4473150	844 KCK	6,5	6,2 – 6,8 mm	38	for general applications	DLC-coated
4473151	844 KCK	7	6,7 – 7,3 mm	38	for general applications	DLC-coated
4473152	844 KCK	7,5	7,2 – 7,8 mm	38	for general applications	DLC-coated
4473153	844 KCK	8	7,7 – 8,3 mm	38	for general applications	DLC-coated
4473154	844 KCK	8,5	8,2 – 8,8 mm	45	for general applications	DLC-coated
4473155	844 KCK	9	8,7 – 9,3 mm	45	for general applications	DLC-coated
4473156	844 KCK	9,5	9,2 – 9,8 mm	45	for general applications	DLC-coated
4473158	844 KCK	10	9,4 – 10,6 mm	45	for general applications	DLC-coated
4473159	844 KCK	11	10,4 – 11,6 mm	45	for general applications	DLC-coated
4473160	844 KCK	12	11,4 – 12,6 mm	45	for general applications	DLC-coated
4473161	844 KCK	13	12,4 – 13,6 mm	45	for general applications	DLC-coated
4473162	844 KCK	14	13,4 – 14,6 mm	45	for general applications	DLC-coated
4473163	844 KCK	15	14,4 – 15,6 mm	45	for general applications	DLC-coated
4473164	844 KCK	16	15,4 – 16,6 mm	45	for general applications	DLC-coated
4473165	844 KCK	17	16,4 – 17,6 mm	45	for general applications	DLC-coated
4473166	844 KCK	18	17,4 – 18,6 mm	45	for general applications	DLC-coated
4473167	844 KCK	19	18,4 – 19,6 mm	45	for general applications	DLC-coated
4473168	844 KCK	20	19,4 – 20,6 mm	45	for general applications	DLC-coated

Marameter 844 KCK

Inside measuring probe

TECHNICAL DATA

Order no.	Dimension H1	Dimension L	Connection thread
	mm	mm	
4473130	0,6	19,5	M6x0,75
4473131	0,6	19,5	M6x0,75
4473132	0,6	19,5	M6x0,75
4473133	0,6	19,5	M6x0,75
4473134	0,6	19,5	M6x0,75
4473135	0,9	25,3	M6x0,75
4473136	0,9	25,3	M6x0,75
4473137	0,9	25,3	M6x0,75
4473138	1,2	30,6	M6x0,75
4473139	1,2	30,6	M6x0,75
4473140	1,2	30,6	M6x0,75
4473141	1,2	30,6	M6x0,75
4473142	1,2	30,6	M6x0,75
4473143	1,2	30,6	M6x0,75
4473145	2	47,3	M6x0,75
4473146	2	47,3	M6x0,75
4473147	2	47,3	M6x0,75
4473148	2	47,3	M6x0,75
4473149	2	47,3	M6x0,75
4473150	2	47,3	M6x0,75
4473151	2	47,3	M6x0,75
4473152	2	47,3	M6x0,75
4473153	2	47,3	M6x0,75
4473154	2	47,3	M6x0,75
4473155	2	47,3	M6x0,75
4473156	2	47,3	M6x0,75
4473158	3,3	48,5	M6x0,75
4473159	3,3	48,5	M6x0,75
4473160	3,3	48,5	M6x0,75
4473161	3,3	48,5	M6x0,75
4473162	3,3	48,5	M6x0,75
4473163	3,3	48,5	M6x0,75
4473164	3,3	48,5	M6x0,75
4473165	3,3	48,5	M6x0,75
4473166	3,3	48,5	M6x0,75
4473167	3,3	48,5	M6x0,75
4473168	3,3	48,5	M6x0,75

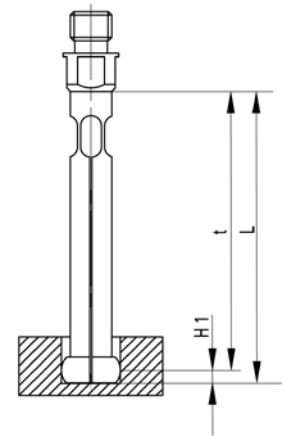

ACCESSORIES

Order no.	Description
4473093	Transfer Pin made of carbide for inside measuring probe 844 K and 844 KC, size 0,95 –1,55 mm
4473094	Transfer Pin made of carbide for inside measuring probe 844 K and 844 KC, size 1,5 –2,45 mm
4473095	Transfer Pin made of carbide for inside measuring probe 844 K and 844 KC, size 2,3 –3,95 mm
4473096	Transfer Pin made of carbide for inside measuring probe 844 K and 844 KC, size 3,7 –9,8 mm
4473097	Transfer Pin made of carbide for inside measuring probe 844 K and 844 KC, size 9,4 –20,6 mm

Marameter 844 Kk

Inside measuring probe

FEATURES

- Measuring head made of hardened steel, hard chrome plated
- Constant measuring force as a result of built-in spring, eliminating user influence
- Extensive modular system is composed of measuring head, transfer needle, holder, depth extension, right angle attachments and setting rings
- The minimum set of a measuring instrument consists of: Measuring head, transfer needle and holder plus indicator unit

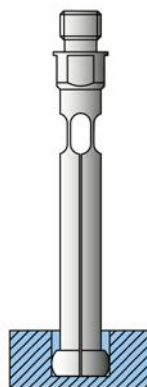

Application:

Standard model

- For indicating measurement of diameter and testing for roundness and conicity of bores
- Especially suitable for testing batches
- Determine the reversal point by rocking in the bore

TECHNICAL DATA

Order no.	Type	Nominal size	Measuring range	Measuring depth	Design	Measuring surface
		mm	mm	mm		
4473030	844 Kk	1	0,95 – 1,15 mm	10,5	for general applications	hard chrome plated
4473031	844 Kk	1,1	1,07 – 1,25 mm	10,5	for general applications	hard chrome plated
4473032	844 Kk	1,2	1,17 – 1,35 mm	10,5	for general applications	hard chrome plated
4473033	844 Kk	1,3	1,27 – 1,45 mm	10,5	for general applications	hard chrome plated
4473034	844 Kk	1,4	1,37 – 1,55 mm	10,5	for general applications	hard chrome plated
4473035	844 Kk	1,75	1,5 – 1,9 mm	16	for general applications	hard chrome plated
4473036	844 Kk	2	1,8 – 2,2 mm	16	for general applications	hard chrome plated
4473037	844 Kk	2,25	2,05 – 2,45 mm	16	for general applications	hard chrome plated
4473038	844 Kk	2,5	2,3 – 2,7 mm	21	for general applications	hard chrome plated
4473039	844 Kk	2,75	2,55 – 2,95 mm	21	for general applications	hard chrome plated
4473040	844 Kk	3	2,8 – 3,2 mm	21	for general applications	hard chrome plated
4473041	844 Kk	3,25	3,05 – 3,45 mm	21	for general applications	hard chrome plated
4473042	844 Kk	3,5	3,3 – 3,7 mm	21	for general applications	hard chrome plated
4473043	844 Kk	3,75	3,55 – 3,95 mm	21	for general applications	hard chrome plated
4473045	844 Kk	4	3,7 – 4,3 mm	38	for general applications	hard chrome plated
4473046	844 Kk	4,5	4,2 – 4,8 mm	38	for general applications	hard chrome plated
4473047	844 Kk	5	4,7 – 5,3 mm	38	for general applications	hard chrome plated
4473048	844 Kk	5,5	5,2 – 5,8 mm	38	for general applications	hard chrome plated
4473049	844 Kk	6	5,7 – 6,3 mm	38	for general applications	hard chrome plated
4473050	844 Kk	6,5	6,2 – 6,8 mm	38	for general applications	hard chrome plated
4473051	844 Kk	7	6,7 – 7,3 mm	38	for general applications	hard chrome plated
4473052	844 Kk	7,5	7,2 – 7,8 mm	38	for general applications	hard chrome plated
4473053	844 Kk	8	7,7 – 8,3 mm	38	for general applications	hard chrome plated
4473054	844 Kk	8,5	8,2 – 8,8 mm	45	for general applications	hard chrome plated
4473055	844 Kk	9	8,7 – 9,3 mm	45	for general applications	hard chrome plated
4473056	844 Kk	9,5	9,2 – 9,8 mm	45	for general applications	hard chrome plated
4473058	844 Kk	10	9,4 – 10,6 mm	45	for general applications	hard chrome plated
4473059	844 Kk	11	10,4 – 11,6 mm	45	for general applications	hard chrome plated
4473060	844 Kk	12	11,4 – 12,6 mm	45	for general applications	hard chrome plated
4473061	844 Kk	13	12,4 – 13,6 mm	45	for general applications	hard chrome plated
4473062	844 Kk	14	13,4 – 14,6 mm	45	for general applications	hard chrome plated
4473063	844 Kk	15	14,4 – 15,6 mm	45	for general applications	hard chrome plated
4473064	844 Kk	16	15,4 – 16,6 mm	45	for general applications	hard chrome plated
4473065	844 Kk	17	16,4 – 17,6 mm	45	for general applications	hard chrome plated
4473066	844 Kk	18	17,4 – 18,6 mm	45	for general applications	hard chrome plated
4473067	844 Kk	19	18,4 – 19,6 mm	45	for general applications	hard chrome plated
4473068	844 Kk	20	19,4 – 20,6 mm	45	for general applications	hard chrome plated

Marameter 844 Kk

Inside measuring probe

TECHNICAL DATA

Order no.	Dimension H1	Dimension L	Connection thread
	mm	mm	
4473030	0,6	19,5	M6x0,75
4473031	0,6	19,5	M6x0,75
4473032	0,6	19,5	M6x0,75
4473033	0,6	19,5	M6x0,75
4473034	0,6	19,5	M6x0,75
4473035	0,9	25,3	M6x0,75
4473036	0,9	25,3	M6x0,75
4473037	0,9	25,3	M6x0,75
4473038	1,2	30,6	M6x0,75
4473039	1,2	30,6	M6x0,75
4473040	1,2	30,6	M6x0,75
4473041	1,2	30,6	M6x0,75
4473042	1,2	30,6	M6x0,75
4473043	1,2	30,6	M6x0,75
4473045	2	47,3	M6x0,75
4473046	2	47,3	M6x0,75
4473047	2	47,3	M6x0,75
4473048	2	47,3	M6x0,75
4473049	2	47,3	M6x0,75
4473050	2	47,3	M6x0,75
4473051	2	47,3	M6x0,75
4473052	2	47,3	M6x0,75
4473053	2	47,3	M6x0,75
4473054	2	47,3	M6x0,75
4473055	2	47,3	M6x0,75
4473056	2	47,3	M6x0,75
4473058	3,3	48,5	M6x0,75
4473059	3,3	48,5	M6x0,75
4473060	3,3	48,5	M6x0,75
4473061	3,3	48,5	M6x0,75
4473062	3,3	48,5	M6x0,75
4473063	3,3	48,5	M6x0,75
4473064	3,3	48,5	M6x0,75
4473065	3,3	48,5	M6x0,75
4473066	3,3	48,5	M6x0,75
4473067	3,3	48,5	M6x0,75
4473068	3,3	48,5	M6x0,75

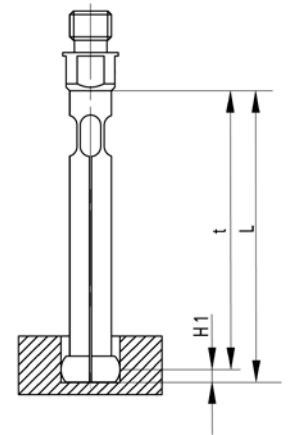

ACCESSORIES

Order no.	Description
4473093	Transfer Pin made of carbide for inside measuring probe 844 K and 844 KC, size 0,95 –1,55 mm
4473094	Transfer Pin made of carbide for inside measuring probe 844 K and 844 KC, size 1,5 –2,45 mm
4473095	Transfer Pin made of carbide for inside measuring probe 844 K and 844 KC, size 2,3 –3,95 mm
4473096	Transfer Pin made of carbide for inside measuring probe 844 K and 844 KC, size 3,7 –9,8 mm
4473097	Transfer Pin made of carbide for inside measuring probe 844 K and 844 KC, size 9,4 –20,6 mm

Marameter 844 KSk

Blind hole measuring probe

FEATURES

- Measuring head made of hardened steel, hard chrome plated
- Constant measuring force as a result of built-in spring, eliminating user influence
- Extensive modular system is composed of measuring head, transfer needle, holder, depth extension, right angle attachments and setting rings

- The minimum set of a measuring instrument consists of: Measuring head, transfer needle and holder plus indicator unit

Application:
Model for Blind Holes

- For measurements near to the bottom of bores
- For indicating measurement of diameter and testing for roundness and conicity of bores
- Especially suitable for testing batches
- Determine the reversal point by rocking in the bore

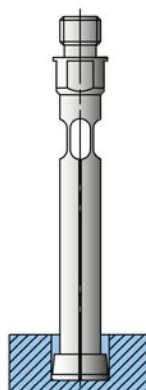

TECHNICAL DATA

Order no.	Type	Nominal size mm	Measuring range mm	Measuring depth mm	Design	Measuring surface
4473245	844 KSk	4	3,7 –4,3 mm	38	for blind hole measurements	hard chrome plated
4473246	844 KSk	4,5	4,2 –4,8 mm	38	for blind hole measurements	hard chrome plated
4473247	844 KSk	5	4,7 –5,3 mm	38	for blind hole measurements	hard chrome plated
4473248	844 KSk	5,5	5,2 –5,8 mm	38	for blind hole measurements	hard chrome plated
4473249	844 KSk	6	5,7 –6,3 mm	38	for blind hole measurements	hard chrome plated
4473250	844 KSk	6,5	6,2 –6,8 mm	38	for blind hole measurements	hard chrome plated
4473251	844 KSk	7	6,7 –7,3 mm	38	for blind hole measurements	hard chrome plated
4473252	844 KSk	7,5	7,2 –7,8 mm	38	for blind hole measurements	hard chrome plated
4473253	844 KSk	8	7,7 –8,3 mm	38	for blind hole measurements	hard chrome plated
4473254	844 KSk	8,5	8,2 –8,8 mm	45	for blind hole measurements	hard chrome plated
4473255	844 KSk	9	8,7 –9,3 mm	45	for blind hole measurements	hard chrome plated
4473256	844 KSk	9,5	9,2 –9,8 mm	45	for blind hole measurements	hard chrome plated
4473258	844 KSk	10	9,4 –10,6 mm	45	for blind hole measurements	hard chrome plated
4473259	844 KSk	11	10,4 –11,6 mm	45	for blind hole measurements	hard chrome plated
4473260	844 KSk	12	11,4 –12,6 mm	45	for blind hole measurements	hard chrome plated
4473261	844 KSk	13	12,4 –13,6 mm	45	for blind hole measurements	hard chrome plated
4473262	844 KSk	14	13,4 –14,6 mm	45	for blind hole measurements	hard chrome plated
4473263	844 KSk	15	14,4 –15,6 mm	45	for blind hole measurements	hard chrome plated
4473264	844 KSk	16	15,4 –16,6 mm	45	for blind hole measurements	hard chrome plated
4473265	844 KSk	17	16,4 –17,6 mm	45	for blind hole measurements	hard chrome plated
4473266	844 KSk	18	17,4 –18,6 mm	45	for blind hole measurements	hard chrome plated
4473267	844 KSk	19	18,4 –19,6 mm	45	for blind hole measurements	hard chrome plated
4473268	844 KSk	20	19,4 –20,6 mm	45	for blind hole measurements	hard chrome plated

Marameter 844 KSk

Blind hole measuring probe

TECHNICAL DATA

Order no.	H2	Dimension L	Connection thread
	mm	mm	
4473245	0,5	47,3	M6x0,75
4473246	0,5	47,3	M6x0,75
4473247	0,5	47,3	M6x0,75
4473248	0,5	47,3	M6x0,75
4473249	0,5	47,3	M6x0,75
4473250	0,5	47,3	M6x0,75
4473251	0,5	47,3	M6x0,75
4473252	0,5	47,3	M6x0,75
4473253	0,5	47,3	M6x0,75
4473254	0,5	47,3	M6x0,75
4473255	0,5	47,3	M6x0,75
4473256	0,5	47,3	M6x0,75
4473258	1	48,5	M6x0,75
4473259	1	48,5	M6x0,75
4473260	1	48,5	M6x0,75
4473261	1	48,5	M6x0,75
4473262	1	48,5	M6x0,75
4473263	1	48,5	M6x0,75
4473264	1	48,5	M6x0,75
4473265	1	48,5	M6x0,75
4473266	1	48,5	M6x0,75
4473267	1	48,5	M6x0,75
4473268	1	48,5	M6x0,75

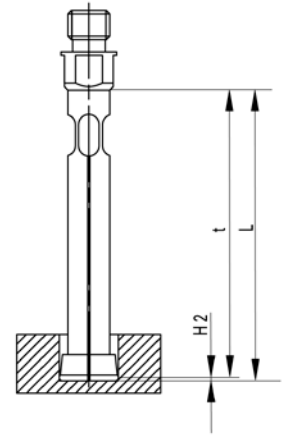

ACCESSORIES

Order no.	Description
4473296	Transfer Pin made of carbide for inside measuring probe 844 KS, size 3,7 –9,8 mm
4473297	Transfer Pin made of carbide for inside measuring probe 844 KS, size 9,4 –20,6 mm

Marameter | Modular System

By combining with a wide range of accessories (indicators, internal probes with drive needles, holders, extensions and right angle attachment), the internal gage becomes a precision measuring instrument, adapted to the measuring task.

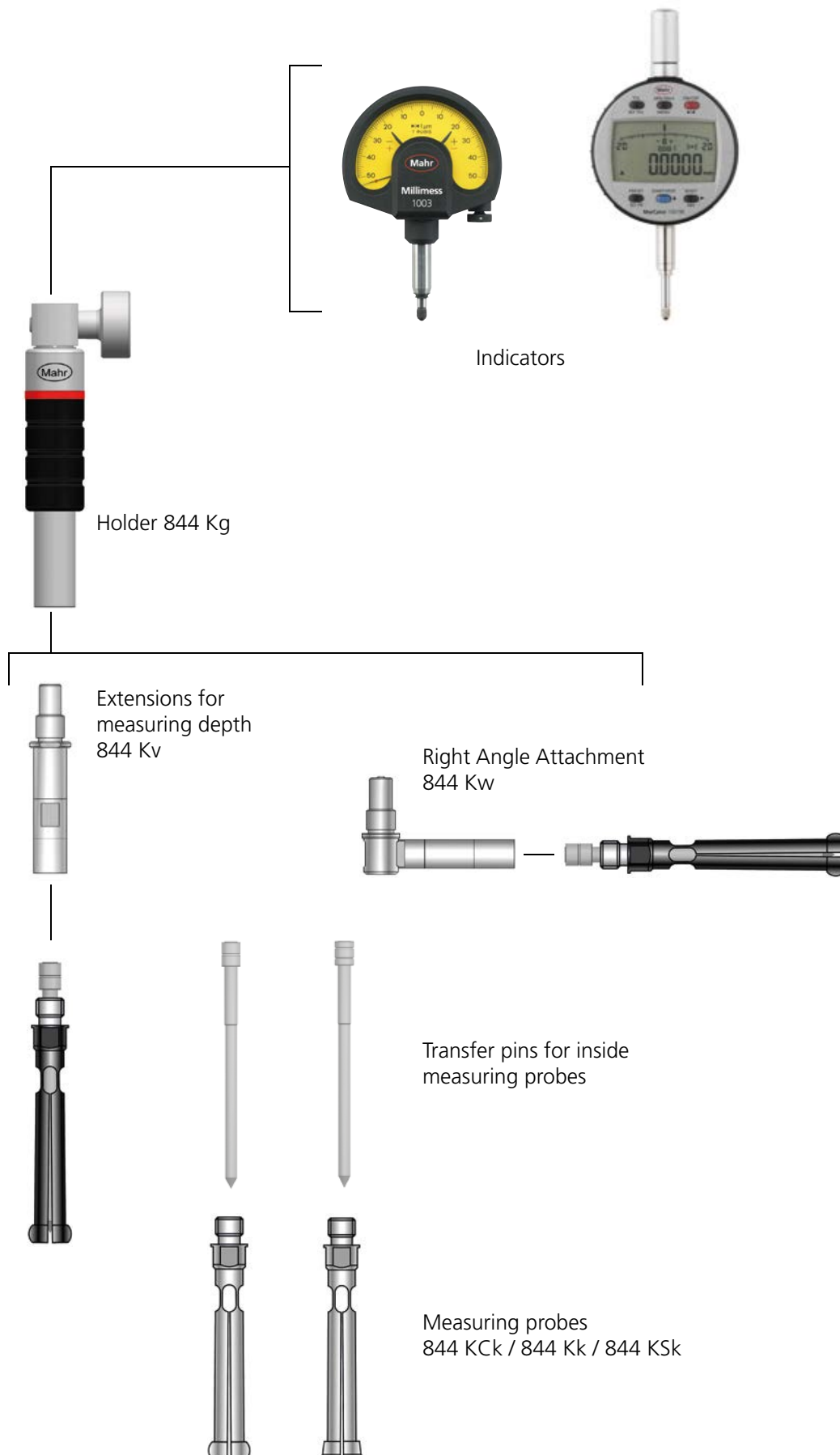

Marameter 844 Kg / 844 Kga / 844 Kgz

Holder for indicator

FEATURES

Holder for mounting an indicator (comparator, dial gage or inductive probe) and connection of an 844 K/KC/KS inside measuring probe or corresponding accessories such as 844 Kt measuring depth extensions or 844 Kw right angle attachment



Application:

Type 844 Kga: Special design with retracting button, for easier insertion of the internal measuring probe into bores. Recommended for small and sensitive bores.

Type 844 Kgz: Special design for dial gages with shaft diameter 3/8 inch (typical for dial gages from USA).

TECHNICAL DATA

Order no.	Type	Mount Ø	Design	Dimension L	d1	l	Connection thread
		mm		mm	mm	mm	
4473400	844 Kg	8 mm	Standard design	73	10	23	M6x0,75
4473401	844 Kga	8 mm	with retract button	73	10	23	M6x0,75
4473402	844 Kgz	.375"	Inch design	73	10	23	M6x0,75

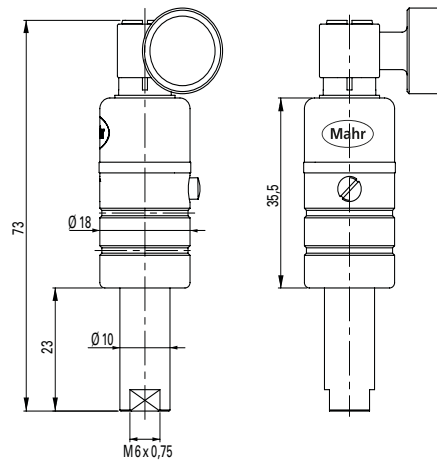

Marameter 844 Kv

Extension for measuring depth

FEATURES

The measuring depth extension is screwed in between the holder (Type 844 Kg/Kga) and the inside probe (Type 844 K/KS/KS)



Application:

To reach measuring points in deep bores

TECHNICAL DATA

Order no.	Type	Dimension L	Connection thread
		mm	
4473405	844 Kv	50	M6x0,75
4473406	844 Kv	100	M6x0,75
4473407	844 Kv	250	M6x0,75

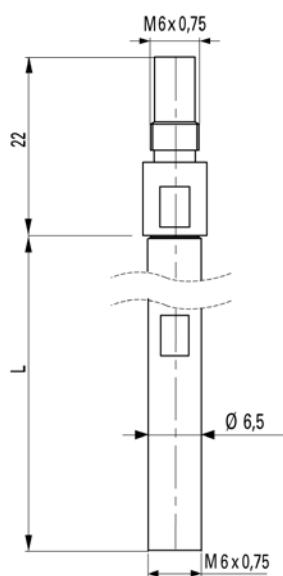

Marameter 844 Kw

Angle attachment 90°

FEATURES

The 844 Kw right angle attachment are screwed in between holder 844 Kg and bore gage 844 K / 844 KC / 844 KS (if necessary extensions 844 Kv)

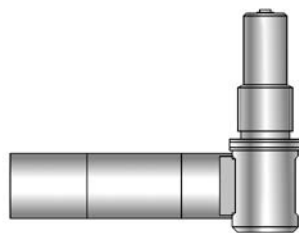

Application:

For space-saving and side-entering measurement of bores

Typical measuring problem situations:

- Narrow conditions in turning and grinding machines
- Side outgoing bores or bearing points in housings

TECHNICAL DATA

Order no.	Type	Dimension L	d	Connection thread
4473409	844 Kw	mm 29	mm 7,9	M6x0,75

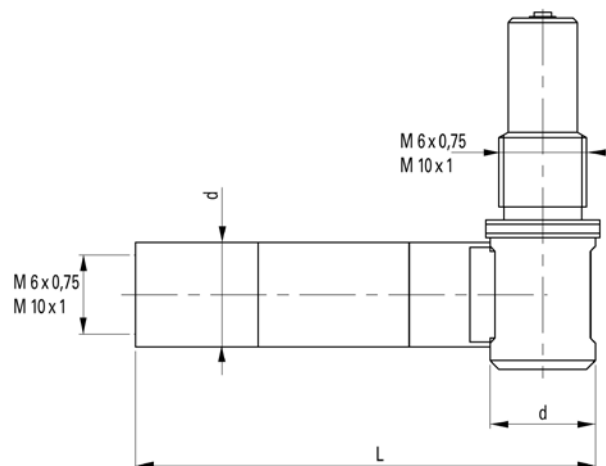

Marameter 844 Ke

Setting rings in set

FEATURES

2 Designs:

Setting rings \varnothing 1,0 –2,75 mm
made of hardened steel
according to factory standard:
manufacturing tolerance of the
bore: $\pm 1 \mu\text{m}$
Setting rings \varnothing 3 –20 mm
made of hardened steel
according to DIN 2250 form Cw

Application:

The setting rings are used as dimensional standards for adjusting the bore gages 844 K/KC/KS to the respective nominal dimension



TECHNICAL DATA

Order no.	Type	Nominal size	Number of setting rings	Model
4473375	844 Ke	mm	Adjustment rings 5	hardened steel
		1		
		1,1		
		1,2		
		1,3		
4473376	844 Ke	1,4	9	hardened steel
		1,75		
		2		
		2,25		
		2,5		
		2,75		
		3		
		3,25		
4473377	844 Ke	3,5	12	hardened steel
		3,75		
		4		
		4,5		
		5		
		5,5		
		6		
		6,5		
		7		
		7,5		
		8		
4473378	844 Ke	8,5	21	hardened steel
		9		
		9,5		
		1,75		
		2		
		2,25		
		2,5		
		2,75		
		3		
		3,25		
		3,5		
		3,75		
		4		
		4,5		
		5		
4473379	844 Ke	5,5	11	hardened steel
		6		
		6,5		
		7		
		7,5		
		8		
		8,5		
		9		
		9,5		
		10		
		11		
12				
13				
14				
15				
16				
17				
18				
19				
20				

Marameter 844 Ke

Setting rings in set

ACCESSORIES

Order no.	Description	Type
4473310	Setting ring, Ø 1 mm	844 Ke
4473311	Setting ring, Ø 1,1 mm	844 Ke
4473312	Setting ring, Ø 1,2 mm	844 Ke
4473313	Setting ring, Ø 1,3 mm	844 Ke
4473314	Setting ring, Ø 1,4 mm	844 Ke
4473315	Setting ring, Ø 1,75 mm	844 Ke
4473316	Setting ring, Ø 2 mm	844 Ke
4473317	Setting ring, Ø 2,25 mm	844 Ke
4473318	Setting ring, Ø 2,5 mm	844 Ke
4473319	Setting ring, Ø 2,75 mm	844 Ke
4710014	Ring gage DIN 2250 C, Ø 3 mm	355 E
4710015	Ring gage DIN 2250 C, Ø 3,25 mm	355 E
4710016	Ring gage DIN 2250 C, Ø 3,5 mm	355 E
4710017	Ring gage DIN 2250 C, Ø 3,75 mm	355 E
4710018	Ring gage DIN 2250 C, Ø 4 mm	355 E
4710019	Ring gage DIN 2250 C, Ø 4,5 mm	355 E
4710020	Ring gage DIN 2250 C, Ø 5 mm	355 E
4710021	Ring gage DIN 2250 C, Ø 5,5 mm	355 E
4710022	Ring gage DIN 2250 C, Ø 6 mm	355 E
4710023	Ring gage DIN 2250 C, Ø 6,5 mm	355 E
4710024	Ring gage DIN 2250 C, Ø 7 mm	355 E
4710025	Ring gage DIN 2250 C, Ø 7,5 mm	355 E
4710026	Ring gage DIN 2250 C, Ø 8 mm	355 E
4710027	Ring gage DIN 2250 C, Ø 8,5 mm	355 E
4710028	Ring gage DIN 2250 C, Ø 9 mm	355 E
4710029	Ring gage DIN 2250 C, Ø 9,5 mm	355 E
4710030	Ring gage DIN 2250 C, Ø 10 mm	355 E
4710031	Ring gage DIN 2250 C, Ø 11 mm	355 E
4710032	Ring gage DIN 2250 C, Ø 12 mm	355 E
4710033	Ring gage DIN 2250 C, Ø 13 mm	355 E
4710034	Ring gage DIN 2250 C, Ø 14 mm	355 E
4710035	Ring gage DIN 2250 C, Ø 15 mm	355 E
4710036	Ring gage DIN 2250 C, Ø 16 mm	355 E
4710037	Ring gage DIN 2250 C, Ø 17 mm	355 E
4710038	Ring gage DIN 2250 C, Ø 18 mm	355 E
4710039	Ring gage DIN 2250 C, Ø 19 mm	355 E
4710040	Ring gage DIN 2250 C, Ø 20 mm	355 E

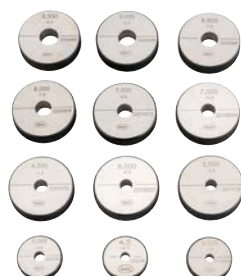

Marameter | Indicating Plug Gage System 844 D

Indicating measurement in highest precision

Plug gages of the 844 D family are 2-point indicating gages, combined with a precisely grinded guide cylinder, which centers itself exactly in bores. This means that no reversal point needs to be determined by rocking. The measured value is displayed reliably, precisely and immediately.

The adjustment to a respective nominal dimension is achieved with setting rings.

Clear Benefits

Fastest and easiest to use, no operator influence, best performance

Special Benefit

- Self-centering: No rocking required to determine the reversal point
- No operator influence
- Especially suitable with use of digital indicators for processing the measured values

Each plug gage is:

- Specific to the requirement
- Matched to the bore diameter
- Matched to the bore tolerance

The following must be indicated with each order

- Order number
- Bore diameter
- Bore tolerance (ISO or numerical value spec.)

Ordering Examples

1 x 4484016 844 D Indicating Plug Gage
Nominal bore size \varnothing 34,5 mm
Bore tolerance H8

1 x 4484048 844 DR Indicating Plug Gage
Nominal bore size \varnothing 74,55 mm
Bore tolerance +0,05 / -0,03

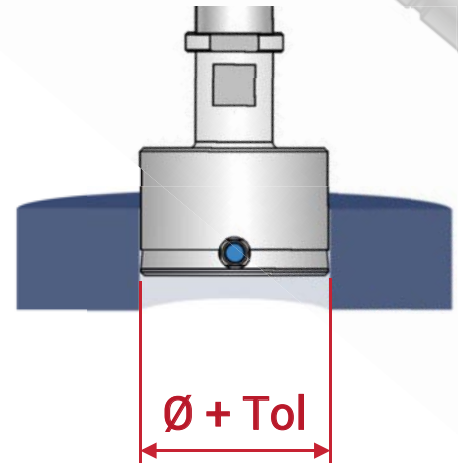

Modular System

By combining with a wide range of accessories (indicators, holders, extensions and right angle attachment), the indicating plug gage become a high precision measuring instrument, adapted to the measuring task.

Samples of application configurations



Standard configuration

- Comparator
- Holder 844 Dg
- Plug Gage



Configuration for defined measuring depth

- Comparator
- Holder 844 Dg
- Extension 844 Dv
- Depth Stop 844 Dt-3
- Plug Gage

Configuration for sideways measuring in defined measuring depth

- Comparator
- Holder 844 Dg
- Angle Attachment 844 Dw
- Plug Gage
- Stop Ring 844 Dt-R



Marameter | Indicating Plug Gage System 844 D

3 Basic Types

Guide cylinder hard chrome-plated, measuring surfaces made of carbide

844 D

Standard version for general applications

- For quick inspection of precise bores

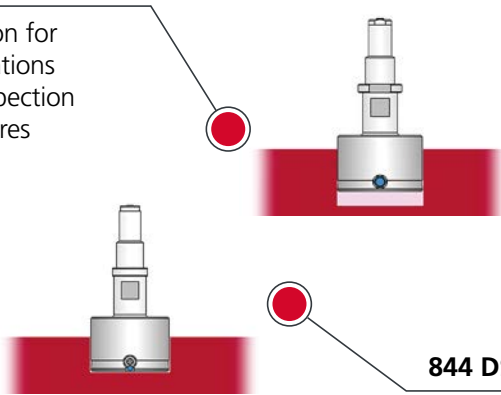

844 DR

Version for through holes and thin-walled holes (metal sheet)

- With extended guide cylinder

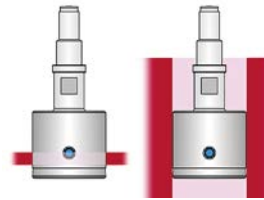

844 DS

Version for blind holes

- For measuring of near to the bottom of the bore

Variants

Variant C: 844 D-C / 844 DR-C / 844 DS-C

Measuring surfaces hard-chrome plated: For sensitive surfaces of non-ferrous metals and aluminum alloys



Variant R: 844 D-R / 844 DR-R / 844 DS-R

Measuring surfaces ruby-tipped: For very sensitive surfaces of non-ferrous metals and aluminum alloy



Variant D: 844 D-D / 844 DR-D

Measuring surfaces diamond-tipped: For very sensitive surfaces of soft non-ferrous metals and aluminum alloys



Variant FD: 844 D-FD / 844 DR-FD

Different front distance "e": Reducing the guide cylinder to measure closer, or at a defined position, to the ground of the bore

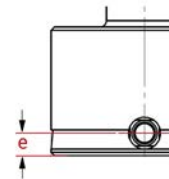

Variant M: 844 D-M / 844 DR-M / 844 DS-M

Extended measuring range: For measuring of larger tolerance fields



Variant HR: 844 D-HR / 844 DR-HR / 844 DS-HR

High Resolution for very narrow bore tolerance zones <math>< 10 \mu\text{m}</math>. More precise manufacturing tolerance of the guide cylinder for tighter gap in the bore, thus reducing axial and radial measuring influences.



Variant F: 844 DS-F

Only with front chamfer (no centering groove): For measuring very short blind holes



Variant 3: 844 D-3 / 844 DR-3

3-Point contact (3 x 120°): For fast measurement of interrupted diameters and detection of shape defects in a polygon

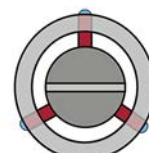

Marameter 844 D

Indicating plug gage

FEATURES

- Measuring head has a hard chrome plated cylinder guide and carbide-tipped anvils
- The carbide expanding pin transfers radial movement to indicating instrument
- Constant measuring force as a result of built-in spring, eliminating user influence
- Extensive modular system is composed of measuring head, holder, depth extension, right angle attachments and depth stops

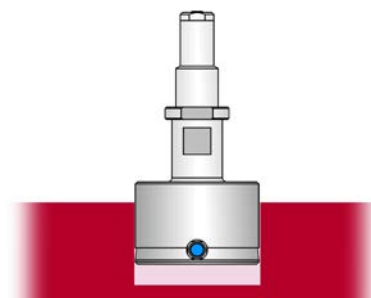

Application: Standard model

- For rapid testing of diameter, roundness and conicity of bores
- Especially suitable for testing batches with tight tolerance zones 10 µm and more
- Rocking in the bore is not required to determine diameter
- Ideal for use in conjunction with digital display units and for subsequent processing of measured values

TECHNICAL DATA

Order no.	Type	Measuring range	Measuring span	Manufacturing tolerance	Linearity deviation fe	Repeatability f _w	a	b	c	e	g	Connection thread
		mm	mm	mm / mm		µm	mm	mm	mm	mm	mm	
4484007	844 D	2- <3	0,15	-0,015 / -0,025	1 %, min. 1 µm	1		21,5	15	1,5	15	M6x0,75
4484008	844 D	3-4	0,2	-0,015 / -0,025	1 %, min. 1 µm	1		33,5	24	1,5	24	M6x0,75
4484009	844 D	>4-6	0,2	-0,015 / -0,025	1 %, min. 1 µm	1	4	33,5	10	1,5	27	M6x0,75
4484010	844 D	>6-9	0,2	-0,015 / -0,025	1 %, min. 1 µm	1	5,7	47	15	2,5	35	M6x0,75
4484011	844 D	>9-12	0,2	-0,015 / -0,025	1 %, min. 1 µm	1	7,9	47	15	2,5	47	M6x0,75
4484012	844 D	>12-13	0,2	-0,015 / -0,025	1 %, min. 1 µm	1	7,9	47	15	2,5	47	M6x0,75
4484013	844 D	>13-16	0,2	-0,015 / -0,025	1 %, min. 1 µm	1	11,9	47	15	2,5	47	M6x0,75
4484014	844 D	>16-20	0,2	-0,015 / -0,025	1 %, min. 1 µm	1	15	37,3	15	2,5		M10x1
4484015	844 D	>20-30	0,2	-0,02 / -0,03	1 %, min. 1 µm	1	15	38,2	20	3,5		M10x1
4484016	844 D	>30-40	0,2	-0,02 / -0,03	1 %, min. 1 µm	1	15	38,2	20	3,5		M10x1
4484017	844 D	>40-60	0,2	-0,02 / -0,03	1 %, min. 1 µm	1	15	38,2	28	3,5		M10x1
4484018	844 D	>60-80	0,2	-0,025 / -0,035	1 %, min. 1 µm	1	17,9	38,8	33	4		M10x1
4484019	844 D	>80-100	0,2	-0,025 / -0,035	1 %, min. 1 µm	1	17,9	38,8	33	4		M10x1
4484020	844 D	>100-110	0,2	-0,025 / -0,035	1 %, min. 1 µm	1	17,9	38,8	33	4		M10x1
4484021	844 D	>110-120	0,2	-0,025 / -0,035	1 %, min. 1 µm	1	17,9	38,8	33	4		M10x1
4484022	844 D	>120-130	0,2	-0,025 / -0,035	1 %, min. 1 µm	1	17,9	38,8	33	4		M10x1
4484023	844 D	>130-140	0,2	-0,035 / -0,045	1 %, min. 1 µm	1	17,9	38,8	33	4		M10x1
4484024	844 D	>140-150	0,2	-0,035 / -0,045	1 %, min. 1 µm	1	17,9	38,8	33	4		M10x1
4484025	844 D	>150-160	0,2	-0,035 / -0,045	1 %, min. 1 µm	1	17,9	38,8	33	4		M10x1
4484026	844 D	>160-170	0,2	-0,035 / -0,045	1 %, min. 1 µm	1	17,9	39	40	4		M10x1
4484027	844 D	>170-180	0,2	-0,035 / -0,045	1 %, min. 1 µm	1	17,9	39	40	4		M10x1
4484028	844 D	>180-190	0,2	-0,035 / -0,045	1 %, min. 1 µm	1	17,9	39	40	4		M10x1
4484029	844 D	>190-200	0,2	-0,035 / -0,045	1 %, min. 1 µm	1	17,9	39	40	4		M10x1

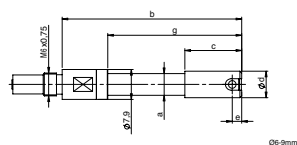

06-9mm

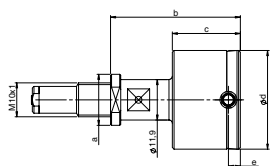

020-40mm

Marameter 844 DR

Indicating plug gage

FEATURES

- Measuring head has a hard chrome plated cylinder guide and carbide-tipped anvils
- The carbide expanding pin transfers radial movement to indicating instrument
- Constant measuring force as a result of built-in spring, eliminating user influence
- Extensive modular system is composed of measuring head, holder, depth extension, right angle attachments and depth stops

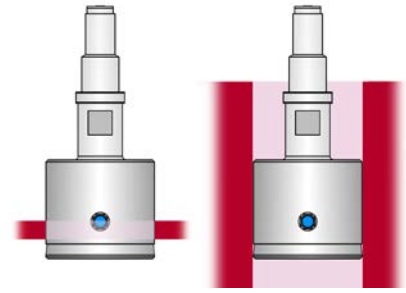

Application: Model for through holes and narrow parts

- With extended guide cylinder for measuring through holes and bores of narrow parts e.g. sheets
- For the rapid testing of diameter, roundness and conicity of bores
- Especially suitable for testing batches with tight tolerance zones 10 µm and more
- Rocking in the bore is not required to determine diameter
- Ideal for use in conjunction with digital display units and for subsequent processing of measured values

TECHNICAL DATA

Order no.	Type	Measuring range	Measuring span	Manu- facturing tolerance	Linearity deviation	Repeatability f _w	a	b	c	e	g	Connection thread
		mm	mm	mm / mm		µm	mm	mm	mm	mm	mm	
4484039	844 DR	4–6	0,2	-0,015 / -0,025	1 %, mind. 1 µm	1	4	38	14,5	6	31,5	M6x0,75
4484040	844 DR	>6–9	0,2	-0,015 / -0,025	1 %, mind. 1 µm	1	5,7	50,5	18,5	6	38,5	M6x0,75
4484041	844 DR	>9–12	0,2	-0,015 / -0,025	1 %, mind. 1 µm	1	7,9	54,5	22,5	10	54,5	M6x0,75
4484042	844 DR	>12–13	0,2	-0,015 / -0,025	1 %, mind. 1 µm	1	7,9	54,5	22,5	10	54,5	M6x0,75
4484043	844 DR	>13–16	0,2	-0,015 / -0,025	1 %, mind. 1 µm	1	11,9	54,5	22,5	10	54,5	M6x0,75
4484044	844 DR	>16–20	0,2	-0,015 / -0,025	1 %, mind. 1 µm	1	15	44,8	22,5	10		M10x1
4484045	844 DR	>20–30	0,2	-0,02 / -0,03	1 %, mind. 1 µm	1	15	44,7	27	10		M10x1
4484046	844 DR	>30–40	0,2	-0,02 / -0,03	1 %, mind. 1 µm	1	15	44,7	27	10		M10x1
4484047	844 DR	>40–60	0,2	-0,02 / -0,03	1 %, mind. 1 µm	1	15	44,7	28	10		M10x1
4484048	844 DR	>60–80	0,2	-0,025 / -0,035	1 %, mind. 1 µm	1	17,9	44,8	33	10		M10x1
4484049	844 DR	>80–100	0,2	-0,025 / -0,035	1 %, mind. 1 µm	1	17,9	44,8	33	10		M10x1
4484050	844 DR	>100–110	0,2	-0,025 / -0,035	1 %, mind. 1 µm	1	17,9	44,8	33	10		M10x1
4484051	844 DR	>110–120	0,2	-0,025 / -0,035	1 %, mind. 1 µm	1	17,9	44,8	33	10		M10x1
4484052	844 DR	>120–130	0,2	-0,025 / -0,035	1 %, mind. 1 µm	1	17,9	44,8	33	10		M10x1
4484053	844 DR	>130–140	0,2	-0,035 / -0,045	1 %, mind. 1 µm	1	17,9	44,8	33	10		M10x1
4484054	844 DR	>140–150	0,2	-0,035 / -0,045	1 %, mind. 1 µm	1	17,9	44,8	33	10		M10x1
4484055	844 DR	>150–160	0,2	-0,035 / -0,045	1 %, mind. 1 µm	1	17,9	44,8	33	10		M10x1
4484056	844 DR	>160–170	0,2	-0,035 / -0,045	1 %, mind. 1 µm	1	17,9	45	40	10		M10x1
4484057	844 DR	>170–180	0,2	-0,035 / -0,045	1 %, mind. 1 µm	1	17,9	45	40	10		M10x1
4484058	844 DR	>180–190	0,2	-0,035 / -0,045	1 %, mind. 1 µm	1	17,9	45	40	10		M10x1
4484059	844 DR	>190–200	0,2	-0,035 / -0,045	1 %, mind. 1 µm	1	17,9	45	40	10		M10x1

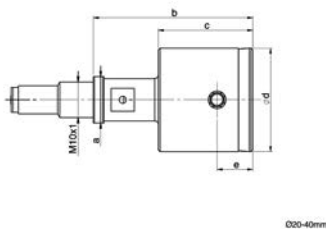
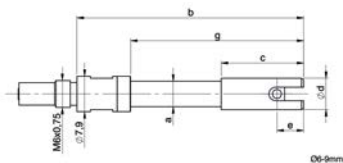

Marameter 844 DS

Indicating plug gage

FEATURES

- Measuring head has a hard chrome plated cylinder guide and carbide-tipped anvils
- The carbide expanding pin transfers radial movement to indicating instrument
- Constant measuring force as a result of built-in spring, eliminating user influence
- Extensive modular system is composed of measuring head, holder, depth extension, right angle attachments and depth stops

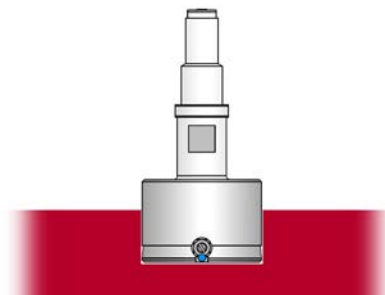

Application: Model for blind holes

- For measurements close to the base of the hole
- For the rapid testing of diameter, roundness and conicity of bores
- Especially suitable for testing batches with tight tolerance zones 10 µm and more
- Rocking in the bore is not required to determine diameter
- Ideal for use in conjunction with digital display units and for subsequent processing of measured values

TECHNICAL DATA

Order no.	Type	Measuring range	Measuring span	Manufacturing tolerance	Linearity deviation fe	Repeatability f _w	a	b	c	e	g	Connection thread
		mm	mm	mm / mm		µm	mm	mm	mm	mm	mm	
4484067	844 DS	2- <3	0,15	-0,015 / -0,025	1,5 %, mind. 1 µm	1		20,7	14,2	0,7	14,2	M6x0,75
4484068	844 DS	3-4	0,2	-0,015 / -0,025	1,5 %, mind. 1 µm	1		33	23,5	1	23,5	M6x0,75
4484069	844 DS	>4-6	0,2	-0,015 / -0,025	1,5 %, mind. 1 µm	1	4	33	9,5	1	26,5	M6x0,75
4484070	844 DS	>6-9	0,2	-0,015 / -0,025	1,5 %, mind. 1 µm	1	5,7	45,5	13,5	1	33,5	M6x0,75
4484071	844 DS	>9-12	0,2	-0,015 / -0,025	1,5 %, mind. 1 µm	1	7,9	45,5	13,5	1	45,5	M6x0,75
4484072	844 DS	>12-13	0,2	-0,015 / -0,025	1,5 %, mind. 1 µm	1	7,9	45,5	13,5	1	45,5	M6x0,75
4484073	844 DS	>13-16	0,2	-0,015 / -0,025	1,5 %, mind. 1 µm	1	11,9	45,5	13,5	1	45,5	M6x0,75
4484074	844 DS	>16-20	0,2	-0,015 / -0,025	1,5 %, mind. 1 µm	1	15	35,8	13,5	1		M10x1
4484075	844 DS	>20-30	0,2	-0,02 / -0,03	1,5 %, mind. 1 µm	1	15	38,2	20	1,2		M10x1
4484076	844 DS	>30-40	0,2	-0,02 / -0,03	1,5 %, mind. 1 µm	1	15	38,2	20	1,2		M10x1
4484077	844 DS	>40-60	0,2	-0,02 / -0,03	1,5 %, mind. 1 µm	1	15	38,2	28	1,2		M10x1
4484078	844 DS	>60-80	0,2	-0,025 / -0,035	1,5 %, mind. 1 µm	1	17,9	39	33	1,2		M10x1
4484079	844 DS	>80-100	0,2	-0,025 / -0,035	1,5 %, mind. 1 µm	1	17,9	39	33	1,2		M10x1
4484080	844 DS	>100-110	0,2	-0,025 / -0,035	1,5 %, mind. 1 µm	1	17,9	39	33	1,2		M10x1
4484081	844 DS	>110-120	0,2	-0,025 / -0,035	1,5 %, mind. 1 µm	1	17,9	39	33	1,2		M10x1
4484082	844 DS	>120-130	0,2	-0,025 / -0,035	1,5 %, mind. 1 µm	1	17,9	39	33	1,2		M10x1
4484083	844 DS	>130-140	0,2	-0,035 / -0,045	1,5 %, mind. 1 µm	1	17,9	39	33	1,2		M10x1
4484084	844 DS	>140-150	0,2	-0,035 / -0,045	1,5 %, mind. 1 µm	1	17,9	39	33	1,2		M10x1
4484085	844 DS	>150-160	0,2	-0,035 / -0,045	1,5 %, mind. 1 µm	1	17,9	39	33	1,2		M10x1
4484086	844 DS	>160-170	0,2	-0,035 / -0,045	1,5 %, mind. 1 µm	1	17,9	38,6	40	1,2		M10x1
4484087	844 DS	>170-180	0,2	-0,035 / -0,045	1,5 %, mind. 1 µm	1	17,9	38,6	40	1,2		M10x1
4484088	844 DS	>180-190	0,2	-0,035 / -0,045	1,5 %, mind. 1 µm	1	17,9	38,6	40	1,2		M10x1
4484089	844 DS	>190-200	0,2	-0,035 / -0,045	1,5 %, mind. 1 µm	1	17,9	38,6	40	1,2		M10x1

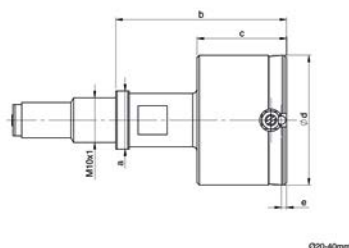
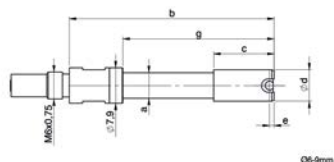

Marameter 844 D-C

Indicating plug gage

FEATURES

- Measuring head has hard chrome plated cylinder guide and hard chrome plated anvils
- The carbide expanding pin transfers radial movement to indicating instrument
- Constant measuring force as a result of built-in spring, eliminating user influence
- Extensive modular system is composed of measuring head, holder, depth extension, right angle attachments and depth stops

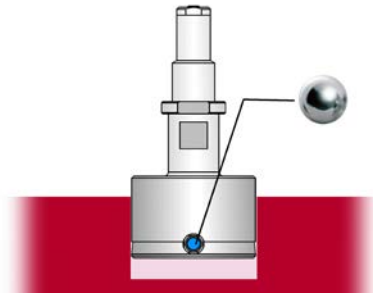

Application: Standard model, measuring surfaces hard chrome-plated
Preferred application on sensitive surfaces of non-ferrous metals and aluminium alloys

- For rapid testing of diameter, roundness and conicity of bores
- Especially suitable for testing batches with tight tolerance zones
- Rocking in the bore is not required to determine diameter
- Ideal for use in conjunction with digital display units and for subsequent processing of measured values

TECHNICAL DATA

Order no.	Type	Measuring range	Measuring span	Manu- facturing tolerance	Linearity deviation f _e	Repeatability f _w	a	b	c	e	g	Connection thread
		mm	mm	mm / mm		µm	mm	mm	mm	mm	mm	
4484100	844 D-C	8-9	0,2	-0,015 / -0,025	1 %, mind. 1 µm	1	5,7	47	15	2,5	35	M6x0,75
4484101	844 D-C	>9-12	0,2	-0,015 / -0,025	1 %, mind. 1 µm	1	7,9	47	15	2,5	47	M6x0,75
4484102	844 D-C	>12-13	0,2	-0,015 / -0,025	1 %, mind. 1 µm	1	7,9	47	15	2,5	47	M6x0,75
4484103	844 D-C	>13-16	0,2	-0,015 / -0,025	1 %, mind. 1 µm	1	11,9	47	15	2,5	47	M6x0,75
4484104	844 D-C	>16-20	0,2	-0,015 / -0,025	1 %, mind. 1 µm	1	15	37,3	15	2,5		M10x1
4484105	844 D-C	>20-30	0,2	-0,02 / -0,03	1 %, mind. 1 µm	1	15	38,2	20	3,5		M10x1
4484106	844 D-C	>30-40	0,2	-0,02 / -0,03	1 %, mind. 1 µm	1	15	38,2	20	3,5		M10x1
4484107	844 D-C	>40-60	0,2	-0,02 / -0,03	1 %, mind. 1 µm	1	15	38,2	28	3,5		M10x1
4484108	844 D-C	>60-80	0,2	-0,025 / -0,035	1 %, mind. 1 µm	1	17,9	38,8	33	4		M10x1
4484109	844 D-C	>80-100	0,2	-0,025 / -0,035	1 %, mind. 1 µm	1	17,9	38,8	33	4		M10x1
4484110	844 D-C	>100-110	0,2	-0,025 / -0,035	1 %, mind. 1 µm	1	17,9	38,8	33	4		M10x1
4484111	844 D-C	>110-120	0,2	-0,025 / -0,035	1 %, mind. 1 µm	1	17,9	38,8	33	4		M10x1
4484112	844 D-C	>120-130	0,2	-0,025 / -0,035	1 %, mind. 1 µm	1	17,9	38,8	33	4		M10x1
4484113	844 D-C	>130-140	0,2	-0,035 / -0,045	1 %, mind. 1 µm	1	17,9	38,8	33	4		M10x1
4484114	844 D-C	>140-150	0,2	-0,035 / -0,045	1 %, mind. 1 µm	1	17,9	38,8	33	4		M10x1
4484115	844 D-C	>150-160	0,2	-0,035 / -0,045	1 %, mind. 1 µm	1	17,9	38,8	33	4		M10x1
4484116	844 D-C	>160-170	0,2	-0,035 / -0,045	1 %, mind. 1 µm	1	17,9	39	40	4		M10x1
4484117	844 D-C	>170-180	0,2	-0,035 / -0,045	1 %, mind. 1 µm	1	17,9	39	40	4		M10x1
4484118	844 D-C	>180-190	0,2	-0,035 / -0,045	1 %, mind. 1 µm	1	17,9	39	40	4		M10x1
4484119	844 D-C	>190-200	0,2	-0,035 / -0,045	1 %, mind. 1 µm	1	17,9	39	40	4		M10x1

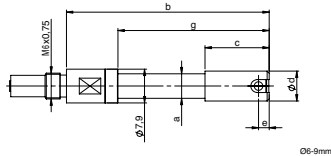

06-9mm

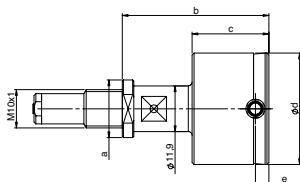

020-40mm

Marameter 844 DR-C

Indicating plug gage

FEATURES

- Measuring head has hard chrome plated cylinder guide and hard chrome plated anvils
- The carbide expanding pin transfers radial movement to indicating instrument
- Constant measuring force as a result of built-in spring, eliminating user influence
- Extensive modular system is composed of measuring head, holder, depth extension, right angle attachments and depth stops

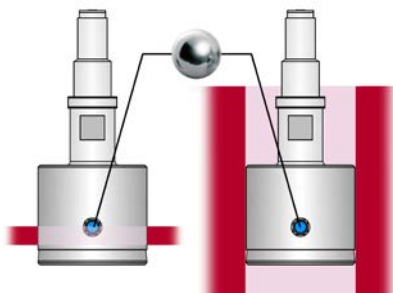

Application: Design for through-holes, hard chrome plated measuring surfaces
Preferred use on sensitive surfaces of non-ferrous metals and aluminum alloys

- With extended guide cylinder for measuring through holes from the edge of the hole
- For the rapid testing of diameter, roundness and conicity of bores
- Especially suitable for testing batches with tight tolerance fields
- Rocking in the bore is not required to determine diameter
- Therefore ideal for use in conjunction with digital display units and for subsequent processing of measured values

TECHNICAL DATA

Order no.	Type	Measuring range	Measuring span	Manufacturing tolerance	Linearity deviation fe	Repeatability f _w	a	b	c	e	g	Connection thread
		mm	mm	mm / mm		μm	mm	mm	mm	mm	mm	
4484130	844 DR-C	8-9	0,2	-0,015 / -0,025	1 %, mind. 1 μm	1	5,7	50,5	18,5	6	38,5	M6x0,75
4484131	844 DR-C	>9-12	0,2	-0,015 / -0,025	1 %, mind. 1 μm	1	7,9	54,5	22,5	10	54,5	M6x0,75
4484132	844 DR-C	>12-13	0,2	-0,015 / -0,025	1 %, mind. 1 μm	1	7,9	54,5	22,5	10	54,5	M6x0,75
4484133	844 DR-C	>13-16	0,2	-0,015 / -0,025	1 %, mind. 1 μm	1	11,9	54,5	22,5	10	54,5	M6x0,75
4484134	844 DR-C	>16-20	0,2	-0,015 / -0,025	1 %, mind. 1 μm	1	15	44,8	22,5	10		M10x1
4484135	844 DR-C	>20-30	0,2	-0,02 / -0,03	1 %, mind. 1 μm	1	15	44,7	27	10		M10x1
4484136	844 DR-C	>30-40	0,2	-0,02 / -0,03	1 %, mind. 1 μm	1	15	44,7	27	10		M10x1
4484137	844 DR-C	>40-60	0,2	-0,02 / -0,03	1 %, mind. 1 μm	1	15	44,7	28	10		M10x1
4484138	844 DR-C	>60-80	0,2	-0,025 / -0,035	1 %, mind. 1 μm	1	17,9	44,8	33	10		M10x1
4484139	844 DR-C	>80-100	0,2	-0,025 / -0,035	1 %, mind. 1 μm	1	17,9	44,8	33	10		M10x1
4484140	844 DR-C	>100-110	0,2	-0,025 / -0,035	1 %, mind. 1 μm	1	17,9	44,8	33	10		M10x1
4484141	844 DR-C	>110-120	0,2	-0,025 / -0,035	1 %, mind. 1 μm	1	17,9	44,8	33	10		M10x1
4484142	844 DR-C	>120-130	0,2	-0,025 / -0,035	1 %, mind. 1 μm	1	17,9	44,8	33	10		M10x1
4484143	844 DR-C	>130-140	0,2	-0,035 / -0,045	1 %, mind. 1 μm	1	17,9	44,8	33	10		M10x1
4484144	844 DR-C	>140-150	0,2	-0,035 / -0,045	1 %, mind. 1 μm	1	17,9	44,8	33	10		M10x1
4484145	844 DR-C	>150-160	0,2	-0,035 / -0,045	1 %, mind. 1 μm	1	17,9	44,8	33	10		M10x1
4484146	844 DR-C	>160-170	0,2	-0,035 / -0,045	1 %, mind. 1 μm	1	17,9	45	40	10		M10x1
4484147	844 DR-C	>170-180	0,2	-0,035 / -0,045	1 %, mind. 1 μm	1	17,9	45	40	10		M10x1
4484148	844 DR-C	>180-190	0,2	-0,035 / -0,045	1 %, mind. 1 μm	1	17,9	45	40	10		M10x1
4484149	844 DR-C	>190-200	0,2	-0,035 / -0,045	1 %, mind. 1 μm	1	17,9	45	40	10		M10x1

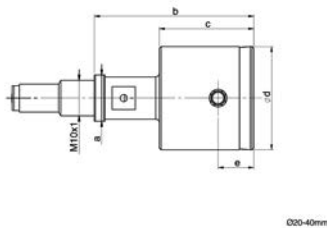
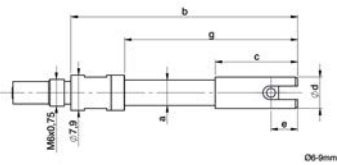

Marameter 844 DS-C

Indicating plug gage

FEATURES

- Measuring head has hard chrome plated cylinder guide and hard chrome plated anvils
- The carbide expanding pin transfers radial movement to indicating instrument
- Constant measuring force as a result of built-in spring, eliminating user influence
- Extensive modular system is composed of measuring head, holder, depth extension, right angle attachments and depth stops

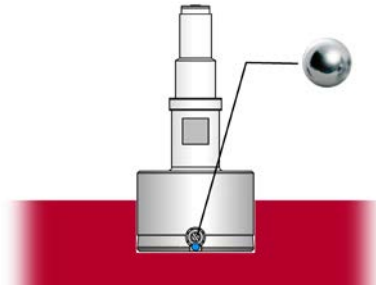

Application: Model for blind holes, measuring surfaces hard chrome-plated
Preferred application on sensitive surfaces of non-ferrous metals and aluminium alloys

- For measurements close to the base of the hole
- For rapid testing of diameter, roundness and conicity of bores
- Especially suitable for testing batches with tight tolerance zones
- Rocking in the bore is not required to determine diameter
- Ideal for use in conjunction with digital display units and for subsequent processing of measured values

TECHNICAL DATA

Order no.	Type	Measuring range	Measuring span	Manu- facturing tolerance	Linearity deviation f _e	Repeatability f _w	a	b	c	e	g	Connection thread
		mm	mm	mm / mm		µm	mm	mm	mm	mm	mm	
4484160	844 DS-C	8–9	0,2	-0,015 / -0,025	1,5 %, mind. 1 µm	1	5,7	45,5	13,5	1	33,5	M6x0,75
4484161	844 DS-C	>9–12	0,2	-0,015 / -0,025	1,5 %, mind. 1 µm	1	7,9	45,5	13,5	1	45,5	M6x0,75
4484162	844 DS-C	>12–13	0,2	-0,015 / -0,025	1,5 %, mind. 1 µm	1	7,9	45,5	13,5	1	45,5	M6x0,75
4484163	844 DS-C	>13–16	0,2	-0,015 / -0,025	1,5 %, mind. 1 µm	1	11,9	45,5	13,5	1	45,5	M6x0,75
4484164	844 DS-C	>16–20	0,2	-0,015 / -0,025	1,5 %, mind. 1 µm	1	15	35,8	13,5	1		M10x1
4484165	844 DS-C	>20–30	0,2	-0,02 / -0,03	1,5 %, mind. 1 µm	1	15	38,2	20	1,2		M10x1
4484166	844 DS-C	>30–40	0,2	-0,02 / -0,03	1,5 %, mind. 1 µm	1	15	38,2	20	1,2		M10x1
4484167	844 DS-C	>40–60	0,2	-0,02 / -0,03	1,5 %, mind. 1 µm	1	15	38,2	28	1,2		M10x1
4484168	844 DS-C	>60–80	0,2	-0,025 / -0,035	1,5 %, mind. 1 µm	1	17,9	39	33	1,2		M10x1
4484169	844 DS-C	>80–100	0,2	-0,025 / -0,035	1,5 %, mind. 1 µm	1	17,9	39	33	1,2		M10x1
4484170	844 DS-C	>100–110	0,2	-0,025 / -0,035	1,5 %, mind. 1 µm	1	17,9	39	33	1,2		M10x1
4484171	844 DS-C	>110–120	0,2	-0,025 / -0,035	1,5 %, mind. 1 µm	1	17,9	39	33	1,2		M10x1
4484172	844 DS-C	>120–130	0,2	-0,025 / -0,035	1,5 %, mind. 1 µm	1	17,9	39	33	1,2		M10x1
4484173	844 DS-C	>130–140	0,2	-0,035 / -0,045	1,5 %, mind. 1 µm	1	17,9	39	33	1,2		M10x1
4484174	844 DS-C	>140–150	0,2	-0,035 / -0,045	1,5 %, mind. 1 µm	1	17,9	39	33	1,2		M10x1
4484175	844 DS-C	>150–160	0,2	-0,035 / -0,045	1,5 %, mind. 1 µm	1	17,9	39	33	1,2		M10x1
4484176	844 DS-C	>160–170	0,2	-0,035 / -0,045	1,5 %, mind. 1 µm	1	17,9	38,6	40	1,2		M10x1
4484177	844 DS-C	>170–180	0,2	-0,035 / -0,045	1,5 %, mind. 1 µm	1	17,9	38,6	40	1,2		M10x1
4484178	844 DS-C	>180–190	0,2	-0,035 / -0,045	1,5 %, mind. 1 µm	1	17,9	38,6	40	1,2		M10x1
4484179	844 DS-C	>190–200	0,2	-0,035 / -0,045	1,5 %, mind. 1 µm	1	17,9	38,6	40	1,2		M10x1

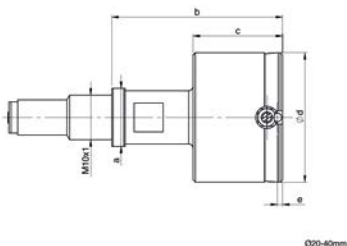
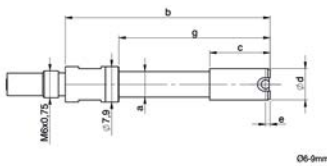

Marameter 844 D-R

Indicating plug gage

FEATURES

- Measuring head has hard chrome plated cylinder guide and ruby-tipped anvils
- The carbide expanding pin transfers radial movement to indicating instrument
- Constant measuring force as a result of built-in spring, eliminating user influence
- Extensive modular system is composed of measuring head, holder, depth extension, right angle attachments and depth stops

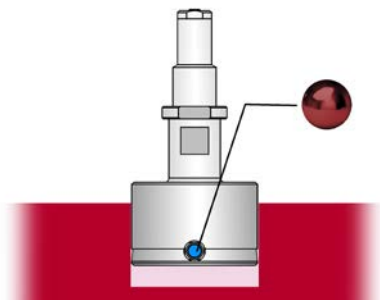

Application: Standard model, measuring surfaces ruby-tipped

Preferred application on sensitive surfaces of non-ferrous metals and aluminium alloys

- For rapid testing of diameter, roundness and conicity of bores
- Especially suitable for testing batches with tight tolerance zones
- Rocking in the bore is not required to determine diameter
- Ideal for use in conjunction with digital display units and for subsequent processing of measured values

TECHNICAL DATA

Order no.	Type	Measuring range	Measuring span	Manufacturing tolerance	Linearity deviation fe	Repeatability f _w	a	b	c	e	g	Connection thread
		mm	mm	mm / mm		µm	mm	mm	mm	mm	mm	
4484208	844 D-R	3-4	0,15	-0,015 / -0,025	1 %, mind. 1 µm	1		33,5	24	1,5	24	M6x0,75
4484209	844 D-R	>4-6	0,2	-0,015 / -0,025	1 %, mind. 1 µm	1	4	33,5	10	1,5	27	M6x0,75
4484210	844 D-R	>6-9	0,2	-0,015 / -0,025	1 %, mind. 1 µm	1	5,7	47	15	2,5	35	M6x0,75
4484211	844 D-R	>9-12	0,2	-0,015 / -0,025	1 %, mind. 1 µm	1	7,9	47	15	2,5	47	M6x0,75
4484212	844 D-R	>12-13	0,2	-0,015 / -0,025	1 %, mind. 1 µm	1	7,9	47	15	2,5	47	M6x0,75
4484213	844 D-R	>13-16	0,2	-0,015 / -0,025	1 %, mind. 1 µm	1	11,9	47	15	2,5	47	M6x0,75
4484214	844 D-R	>16-20	0,2	-0,015 / -0,025	1 %, mind. 1 µm	1	15	37,3	15	2,5		M10x1
4484215	844 D-R	>20-30	0,2	-0,02 / -0,03	1 %, mind. 1 µm	1	15	38,2	20	3,5		M10x1
4484216	844 D-R	>30-40	0,2	-0,02 / -0,03	1 %, mind. 1 µm	1	15	38,2	20	3,5		M10x1
4484217	844 D-R	>40-60	0,2	-0,02 / -0,03	1 %, mind. 1 µm	1	15	38,2	28	3,5		M10x1
4484218	844 D-R	>60-80	0,2	-0,025 / -0,035	1 %, mind. 1 µm	1	17,9	38,8	33	4		M10x1
4484219	844 D-R	>80-100	0,2	-0,025 / -0,035	1 %, mind. 1 µm	1	17,9	38,8	33	4		M10x1
4484220	844 D-R	>100-110	0,2	-0,025 / -0,035	1 %, mind. 1 µm	1	17,9	38,8	33	4		M10x1
4484221	844 D-R	>110-120	0,2	-0,025 / -0,035	1 %, mind. 1 µm	1	17,9	38,8	33	4		M10x1
4484222	844 D-R	>120-130	0,2	-0,025 / -0,035	1 %, mind. 1 µm	1	17,9	38,8	33	4		M10x1
4484223	844 D-R	>130-140	0,2	-0,035 / -0,045	1 %, mind. 1 µm	1	17,9	38,8	33	4		M10x1
4484224	844 D-R	>140-150	0,2	-0,035 / -0,045	1 %, mind. 1 µm	1	17,9	38,8	33	4		M10x1
4484225	844 D-R	>150-160	0,2	-0,035 / -0,045	1 %, mind. 1 µm	1	17,9	38,8	33	4		M10x1
4484226	844 D-R	>160-170	0,2	-0,035 / -0,045	1 %, mind. 1 µm	1	17,9	39	40	4		M10x1
4484227	844 D-R	>170-180	0,2	-0,035 / -0,045	1 %, mind. 1 µm	1	17,9	39	40	4		M10x1
4484228	844 D-R	>180-190	0,2	-0,035 / -0,045	1 %, mind. 1 µm	1	17,9	39	40	4		M10x1
4484229	844 D-R	>190-200	0,2	-0,035 / -0,045	1 %, mind. 1 µm	1	17,9	39	40	4		M10x1

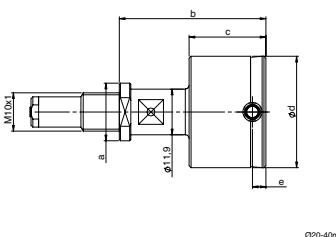
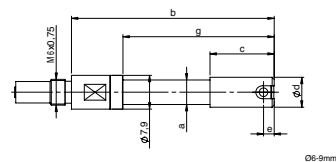

Marameter 844 DR-R

Indicating plug gage

FEATURES

- Measuring head has hard chrome plated cylinder guide and ruby-tipped anvils
- The carbide expanding pin transfers radial movement to indicating instrument
- Constant measuring force as a result of built-in spring, eliminating user influence
- Extensive modular system is composed of measuring head, holder, depth extension, right angle attachments and depth stops

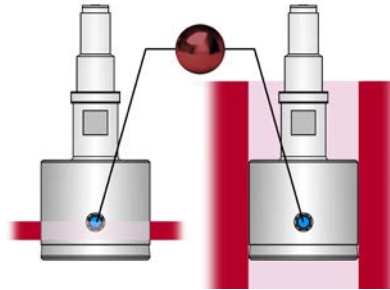

Application: Design for through-holes, ruby-tipped measuring surfaces
Preferred use on sensitive surfaces of non-ferrous metals and aluminum alloys

- With extended guide cylinder for measuring through holes from the edge of the hole
- For the rapid testing of diameter, roundness and conicity of bores
- Especially suitable for testing batches with tight tolerance fields
- Rocking in the bore is not required to determine diameter
- Therefore ideal for use in conjunction with digital display units and for subsequent processing of measured values

TECHNICAL DATA

Order no.	Type	Measuring range	Measuring span	Manu- facturing tolerance	Linearity deviation fe	Repeatability f _w	a	b	c	e	g	Connection thread
		mm	mm	mm / mm		µm	mm	mm	mm	mm	mm	
4484239	844 DR-R	4-6	0,2	-0,015 / -0,025	1 %, mind. 1 µm	1	4	38	14,5	6	31,5	M6x0,75
4484240	844 DR-R	>6-9	0,2	-0,015 / -0,025	1 %, mind. 1 µm	1	5,7	50,5	18,5	6	38,5	M6x0,75
4484241	844 DR-R	>9-12	0,2	-0,015 / -0,025	1 %, mind. 1 µm	1	7,9	54,5	22,5	10	54,5	M6x0,75
4484242	844 DR-R	>12-13	0,2	-0,015 / -0,025	1 %, mind. 1 µm	1	7,9	54,5	22,5	10	54,5	M6x0,75
4484243	844 DR-R	>13-16	0,2	-0,015 / -0,025	1 %, mind. 1 µm	1	11,9	54,5	22,5	10	54,5	M6x0,75
4484244	844 DR-R	>16-20	0,2	-0,015 / -0,025	1 %, mind. 1 µm	1	15	44,8	22,5	10		M10x1
4484245	844 DR-R	>20-30	0,2	-0,02 / -0,03	1 %, mind. 1 µm	1	15	44,7	27	10		M10x1
4484246	844 DR-R	>30-40	0,2	-0,02 / -0,03	1 %, mind. 1 µm	1	15	44,7	27	10		M10x1
4484247	844 DR-R	>40-60	0,2	-0,02 / -0,03	1 %, mind. 1 µm	1	15	44,7	28	10		M10x1
4484248	844 DR-R	>60-80	0,2	-0,025 / -0,035	1 %, mind. 1 µm	1	17,9	44,8	33	10		M10x1
4484249	844 DR-R	>80-100	0,2	-0,025 / -0,035	1 %, mind. 1 µm	1	17,9	44,8	33	10		M10x1
4484250	844 DR-R	>100-110	0,2	-0,025 / -0,035	1 %, mind. 1 µm	1	17,9	44,8	33	10		M10x1
4484251	844 DR-R	>110-120	0,2	-0,025 / -0,035	1 %, mind. 1 µm	1	17,9	44,8	33	10		M10x1
4484252	844 DR-R	>120-130	0,2	-0,025 / -0,035	1 %, mind. 1 µm	1	17,9	44,8	33	10		M10x1
4484253	844 DR-R	>130-140	0,2	-0,035 / -0,045	1 %, mind. 1 µm	1	17,9	44,8	33	10		M10x1
4484254	844 DR-R	>140-150	0,2	-0,035 / -0,045	1 %, mind. 1 µm	1	17,9	44,8	33	10		M10x1
4484255	844 DR-R	>150-160	0,2	-0,035 / -0,045	1 %, mind. 1 µm	1	17,9	44,8	33	10		M10x1
4484256	844 DR-R	>160-170	0,2	-0,035 / -0,045	1 %, mind. 1 µm	1	17,9	45	40	10		M10x1
4484257	844 DR-R	>170-180	0,2	-0,035 / -0,045	1 %, mind. 1 µm	1	17,9	45	40	10		M10x1
4484258	844 DR-R	>180-190	0,2	-0,035 / -0,045	1 %, mind. 1 µm	1	17,9	45	40	10		M10x1
4484259	844 DR-R	>190-200	0,2	-0,035 / -0,045	1 %, mind. 1 µm	1	17,9	45	40	10		M10x1

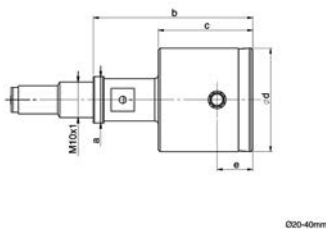
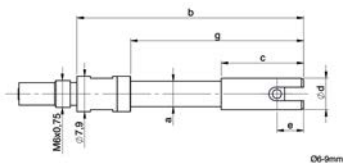

Marameter 844 DS-R

Indicating plug gage

FEATURES

- Measuring head has hard chrome plated cylinder guide and ruby-tipped anvils
- The carbide expanding pin transfers radial movement to indicating instrument
- Constant measuring force as a result of built-in spring, eliminating user influence
- Extensive modular system is composed of measuring head, holder, depth extension, right angle attachments and depth stops

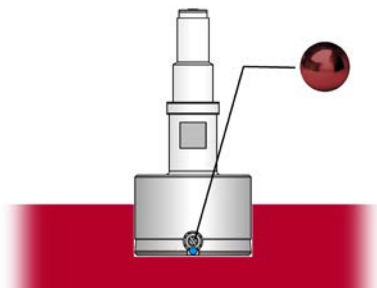

Application: Model for blind holes, measuring surfaces ruby-tipped

Preferred application on sensitive surfaces of non-ferrous metals and aluminium alloys

- For measurements close to the base of the hole
- For rapid testing of diameter, roundness and conicity of bores
- Especially suitable for testing batches with tight tolerance zones
- Rocking in the bore is not required to determine diameter
- Ideal for use in conjunction with digital display units and for subsequent processing of measured values

TECHNICAL DATA

Order no.	Type	Measuring range	Measuring span	Manufacturing tolerance	Linearity deviation fe	Repeatability f _w	a	b	c	e	g	Connection thread
		mm	mm	mm / mm		µm	mm	mm	mm	mm	mm	
4484268	844 DS-R	3–4	0,2	-0,015 / -0,025	1,5 %, mind. 1 µm	1		33	23,5	1	23,5	M6x0,75
4484269	844 DS-R	>4–6	0,2	-0,015 / -0,025	1,5 %, mind. 1 µm	1	4	33	9,5	1	26,5	M6x0,75
4484270	844 DS-R	>6–9	0,2	-0,015 / -0,025	1,5 %, mind. 1 µm	1	5,7	45,5	13,5	1	33,5	M6x0,75
4484271	844 DS-R	>9–12	0,2	-0,015 / -0,025	1,5 %, mind. 1 µm	1	7,9	45,5	13,5	1	45,5	M6x0,75
4484272	844 DS-R	>12–13	0,2	-0,015 / -0,025	1,5 %, mind. 1 µm	1	7,9	45,5	13,5	1	45,5	M6x0,75
4484273	844 DS-R	>13–16	0,2	-0,015 / -0,025	1,5 %, mind. 1 µm	1	11,9	45,5	13,5	1	45,5	M6x0,75
4484274	844 DS-R	>16–20	0,2	-0,015 / -0,025	1,5 %, mind. 1 µm	1	15	35,8	13,5	1		M10x1
4484275	844 DS-R	>20–30	0,2	-0,02 / -0,03	1,5 %, mind. 1 µm	1	15	38,2	20	1,2		M10x1
4484276	844 DS-R	>30–40	0,2	-0,02 / -0,03	1,5 %, mind. 1 µm	1	15	38,2	20	1,2		M10x1
4484277	844 DS-R	>40–60	0,2	-0,02 / -0,03	1,5 %, mind. 1 µm	1	15	38,2	28	1,2		M10x1
4484278	844 DS-R	>60–80	0,2	-0,025 / -0,035	1,5 %, mind. 1 µm	1	17,9	39	33	1,2		M10x1
4484279	844 DS-R	>80–100	0,2	-0,025 / -0,035	1,5 %, mind. 1 µm	1	17,9	39	33	1,2		M10x1
4484280	844 DS-R	>100–110	0,2	-0,025 / -0,035	1,5 %, mind. 1 µm	1	17,9	39	33	1,2		M10x1
4484281	844 DS-R	>110–120	0,2	-0,025 / -0,035	1,5 %, mind. 1 µm	1	17,9	39	33	1,2		M10x1
4484282	844 DS-R	>120–130	0,2	-0,025 / -0,035	1,5 %, mind. 1 µm	1	17,9	39	33	1,2		M10x1
4484283	844 DS-R	>130–140	0,2	-0,035 / -0,045	1,5 %, mind. 1 µm	1	17,9	39	33	1,2		M10x1
4484284	844 DS-R	>140–150	0,2	-0,035 / -0,045	1,5 %, mind. 1 µm	1	17,9	39	33	1,2		M10x1
4484285	844 DS-R	>150–160	0,2	-0,035 / -0,045	1,5 %, mind. 1 µm	1	17,9	39	33	1,2		M10x1
4484286	844 DS-R	>160–170	0,2	-0,035 / -0,045	1,5 %, mind. 1 µm	1	17,9	38,6	40	1,2		M10x1
4484287	844 DS-R	>170–180	0,2	-0,035 / -0,045	1,5 %, mind. 1 µm	1	17,9	38,6	40	1,2		M10x1
4484288	844 DS-R	>180–190	0,2	-0,035 / -0,045	1,5 %, mind. 1 µm	1	17,9	38,6	40	1,2		M10x1
4484289	844 DS-R	>190–200	0,2	-0,035 / -0,045	1,5 %, mind. 1 µm	1	17,9	38,6	40	1,2		M10x1

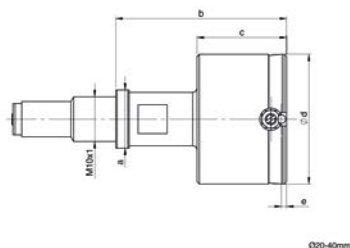
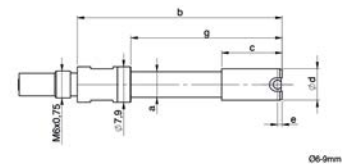

Marameter 844 D-D

Indicating plug gage

FEATURES

- Measuring head has hard chrome plated cylinder guide and diamond-tipped anvils
- The carbide expanding pin transfers radial movement to indicating instrument
- Constant measuring force as a result of built-in spring, eliminating user influence
- Extensive modular system is composed of measuring head, holder, depth extension, right angle attachments and depth stops

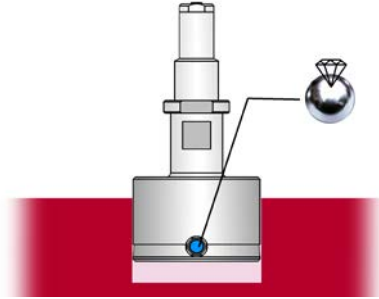

Application: Standard model, measuring surfaces diamond-tipped

Preferred application on very sensitive surfaces of soft non-ferrous metals and aluminium alloys

- For rapid testing of diameter, roundness and conicity of bores
- Especially suitable for testing batches with tight tolerance zones
- Rocking in the bore is not required to determine diameter
- Ideal for use in conjunction with digital display units and for subsequent processing of measured values

TECHNICAL DATA

Order no.	Type	Measuring range	Measuring span	Manu- facturing tolerance	Linearity deviation f _e	Repeatability f _w	a	b	c	e	g	Connection thread
		mm	mm	mm / mm		µm	mm	mm	mm	mm	mm	
4484300	844 D-D	8-9	0,2	-0,015 / -0,025	1 %, mind. 1 µm	1	5,7	47	15	2,5	35	M6x0,75
4484301	844 D-D	>9-12	0,2	-0,015 / -0,025	1 %, mind. 1 µm	1	7,9	47	15	2,5	47	M6x0,75
4484302	844 D-D	>12-13	0,2	-0,015 / -0,025	1 %, mind. 1 µm	1	7,9	47	15	2,5	47	M6x0,75
4484303	844 D-D	>13-16	0,2	-0,015 / -0,025	1 %, mind. 1 µm	1	11,9	47	15	2,5	47	M6x0,75
4484304	844 D-D	>16-20	0,2	-0,015 / -0,025	1 %, mind. 1 µm	1	15	37,3	15	2,5		M10x1
4484305	844 D-D	>20-30	0,2	-0,02 / -0,03	1 %, mind. 1 µm	1	15	38,2	20	3,5		M10x1
4484306	844 D-D	>30-40	0,2	-0,02 / -0,03	1 %, mind. 1 µm	1	15	38,2	20	3,5		M10x1
4484307	844 D-D	>40-60	0,2	-0,02 / -0,03	1 %, mind. 1 µm	1	15	38,2	28	3,5		M10x1
4484308	844 D-D	>60-80	0,2	-0,025 / -0,035	1 %, mind. 1 µm	1	17,9	38,8	33	4		M10x1
4484309	844 D-D	>80-100	0,2	-0,025 / -0,035	1 %, mind. 1 µm	1	17,9	38,8	33	4		M10x1
4484310	844 D-D	>100-110	0,2	-0,025 / -0,035	1 %, mind. 1 µm	1	17,9	38,8	33	4		M10x1
4484311	844 D-D	>110-120	0,2	-0,025 / -0,035	1 %, mind. 1 µm	1	17,9	38,8	33	4		M10x1
4484312	844 D-D	>120-130	0,2	-0,025 / -0,035	1 %, mind. 1 µm	1	17,9	38,8	33	4		M10x1
4484313	844 D-D	>130-140	0,2	-0,035 / -0,045	1 %, mind. 1 µm	1	17,9	38,8	33	4		M10x1
4484314	844 D-D	>140-150	0,2	-0,035 / -0,045	1 %, mind. 1 µm	1	17,9	38,8	33	4		M10x1
4484315	844 D-D	>150-160	0,2	-0,035 / -0,045	1 %, mind. 1 µm	1	17,9	38,8	33	4		M10x1
4484316	844 D-D	>160-170	0,2	-0,035 / -0,045	1 %, mind. 1 µm	1	17,9	39	40	4		M10x1
4484317	844 D-D	>170-180	0,2	-0,035 / -0,045	1 %, mind. 1 µm	1	17,9	39	40	4		M10x1
4484318	844 D-D	>180-190	0,2	-0,035 / -0,045	1 %, mind. 1 µm	1	17,9	39	40	4		M10x1
4484319	844 D-D	>190-200	0,2	-0,035 / -0,045	1 %, mind. 1 µm	1	17,9	39	40	4		M10x1

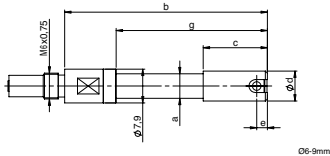

06-9mm

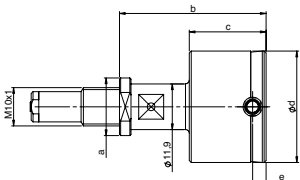

020-40mm

Marameter 844 DR-D

Indicating plug gage

FEATURES

- Measuring head has hard chrome plated cylinder guide and diamond-tipped anvils
- The carbide expanding pin transfers radial movement to indicating instrument
- Constant measuring force as a result of built-in spring, eliminating user influence
- Extensive modular system is composed of measuring head, holder, depth extension, right angle attachments and depth stops

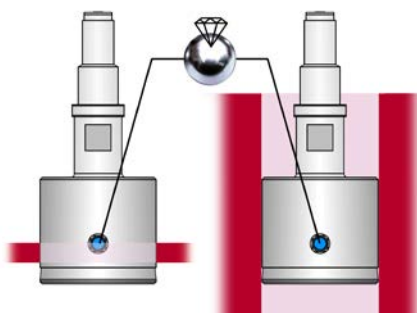

Application: Model for through holes, measuring surfaces diamond-tipped

Preferred application on very sensitive surfaces of soft non-ferrous metals and aluminium alloys

- With extended guide cylinder for measuring through holes from the edge of the hole
- For rapid testing of diameter, roundness and conicity of bores
- Especially suitable for testing batches with tight tolerance zones
- Rocking in the bore is not required to determine diameter
- Ideal for use in conjunction with digital display units and for subsequent processing of measured values

TECHNICAL DATA

Order no.	Type	Measuring range	Measuring span	Manufacturing tolerance	Linearity deviation fe	Repeatability f _w	a	b	c	e	g	Connection thread
		mm	mm	mm / mm		µm	mm	mm	mm	mm	mm	
4484330	844 DR-D	8-9	0,2	-0,015 / -0,025	1 %, mind. 1 µm	1	5,7	50,5	18,5	6	38,5	M6x0,75
4484331	844 DR-D	>9-12	0,2	-0,015 / -0,025	1 %, mind. 1 µm	1	7,9	54,5	22,5	10	54,5	M6x0,75
4484332	844 DR-D	>12-13	0,2	-0,015 / -0,025	1 %, mind. 1 µm	1	7,9	54,5	22,5	10	54,5	M6x0,75
4484333	844 DR-D	>13-16	0,2	-0,015 / -0,025	1 %, mind. 1 µm	1	11,9	54,5	22,5	10	54,5	M6x0,75
4484334	844 DR-D	>16-20	0,2	-0,015 / -0,025	1 %, mind. 1 µm	1	15	44,8	22,5	10		M10x1
4484335	844 DR-D	>20-30	0,2	-0,02 / -0,03	1 %, mind. 1 µm	1	15	44,7	27	10		M10x1
4484336	844 DR-D	>30-40	0,2	-0,02 / -0,03	1 %, mind. 1 µm	1	15	44,7	27	10		M10x1
4484337	844 DR-D	>40-60	0,2	-0,02 / -0,03	1 %, mind. 1 µm	1	15	44,7	28	10		M10x1
4484338	844 DR-D	>60-80	0,2	-0,025 / -0,035	1 %, mind. 1 µm	1	17,9	44,8	33	10		M10x1
4484339	844 DR-D	>80-100	0,2	-0,025 / -0,035	1 %, mind. 1 µm	1	17,9	44,8	33	10		M10x1
4484340	844 DR-D	>100-110	0,2	-0,025 / -0,035	1 %, mind. 1 µm	1	17,9	44,8	33	10		M10x1
4484341	844 DR-D	>110-120	0,2	-0,025 / -0,035	1 %, mind. 1 µm	1	17,9	44,8	33	10		M10x1
4484342	844 DR-D	>120-130	0,2	-0,025 / -0,035	1 %, mind. 1 µm	1	17,9	44,8	33	10		M10x1
4484343	844 DR-D	>130-140	0,2	-0,035 / -0,045	1 %, mind. 1 µm	1	17,9	44,8	33	10		M10x1
4484344	844 DR-D	>140-150	0,2	-0,035 / -0,045	1 %, mind. 1 µm	1	17,9	44,8	33	10		M10x1
4484345	844 DR-D	>150-160	0,2	-0,035 / -0,045	1 %, mind. 1 µm	1	17,9	44,8	33	10		M10x1
4484346	844 DR-D	>160-170	0,2	-0,035 / -0,045	1 %, mind. 1 µm	1	17,9	45	40	10		M10x1
4484347	844 DR-D	>170-180	0,2	-0,035 / -0,045	1 %, mind. 1 µm	1	17,9	45	40	10		M10x1
4484348	844 DR-D	>180-190	0,2	-0,035 / -0,045	1 %, mind. 1 µm	1	17,9	45	40	10		M10x1
4484349	844 DR-D	>190-200	0,2	-0,035 / -0,045	1 %, mind. 1 µm	1	17,9	45	40	10		M10x1

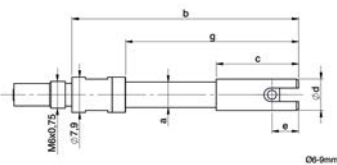

06-9mm

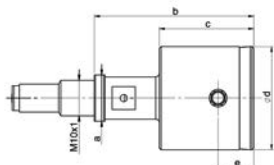

020-40mm

Marameter 844 D-FD

Indicating plug gage

FEATURES

- The front distance “e” must be defined between dimension “e-min” and “e-max”. **Please specify when ordering!**
- Measuring head has hard chrome plated cylinder guide and carbide-tipped anvils
- The carbide expanding pin transfers radial movement to indicating instrument
- Constant measuring force as a result of built-in spring, eliminating user influence
- Extensive modular system is composed of measuring head, holder, depth extension, right angle attachments and depth stops

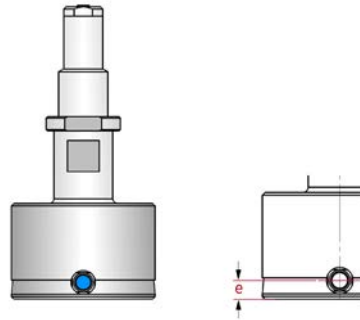

Application: Standard version, measuring contacts with customer-specified location “e”
Shorter guide cylinder for measuring closer to the bottom of the hole or at a defined spot

- For the rapid testing of diameter, roundness and conicity of holes
- Especially suitable for testing batches with tight tolerance fields
- Rocking in the bore is not required to determine diameter
- Therefore ideal for use in conjunction with digital display units and for subsequent processing of measured values

TECHNICAL DATA

Order no.	Type	Measuring range	Measuring span	Manufacturing tolerance	Linearity deviation f_e	Repeatability f_w	a	b	c	e	g	Connection thread
		mm	mm	mm / mm		μm	mm	mm	mm	mm	mm	
4484387	844 D-FD	2–2,999	0,15	-0,015 / -0,025	1,5 %, mind. 1 μm	1		20,7	14,2	0,8 – 1,4	14,2	M6x0,75
4484388	844 D-FD	3–4	0,2	-0,015 / -0,025	1,5 %, mind. 1 μm	1		33	23,5	1,1 – 1,4	23,5	M6x0,75
4484389	844 D-FD	>4–6	0,2	-0,015 / -0,025	1,5 %, mind. 1 μm	1	4	33	9,5	1,1 – 1,4	26,5	M6x0,75
4484390	844 D-FD	>6–9	0,2	-0,015 / -0,025	1,5 %, mind. 1 μm	1	5,7	45,5	13,5	1,1 – 2,4	33,5	M6x0,75
4484391	844 D-FD	>9–12	0,2	-0,015 / -0,025	1,5 %, mind. 1 μm	1	7,9	45,5	13,5	1,1 – 2,4	45,5	M6x0,75
4484392	844 D-FD	>12–13	0,2	-0,015 / -0,025	1,5 %, mind. 1 μm	1	7,9	45,5	13,5	1,1 – 2,4	45,5	M6x0,75
4484393	844 D-FD	>13–16	0,2	-0,015 / -0,025	1,5 %, mind. 1 μm	1	11,9	45,5	13,5	1,1 – 2,4	45,5	M6x0,75
4484394	844 D-FD	>16–20	0,2	-0,015 / -0,025	1,5 %, mind. 1 μm	1	15	35,8	13,5	1,1 – 2,4		M10x1
4484395	844 D-FD	>20–30	0,2	-0,02 / -0,03	1,5 %, mind. 1 μm	1	15	38,2	20	1,3 – 3,4		M10x1
4484396	844 D-FD	>30–40	0,2	-0,02 / -0,03	1,5 %, mind. 1 μm	1	15	38,2	20	1,3 – 3,4		M10x1
4484397	844 D-FD	>40–60	0,2	-0,02 / -0,03	1,5 %, mind. 1 μm	1	15	38,2	28	1,3 – 3,4		M10x1
4484398	844 D-FD	>60–80	0,2	-0,025 / -0,035	1,5 %, mind. 1 μm	1	17,9	39	33	1,3 – 3,9		M10x1
4484399	844 D-FD	>80–100	0,2	-0,025 / -0,035	1,5 %, mind. 1 μm	1	17,9	39	33	1,3 – 3,9		M10x1
4484400	844 D-FD	>100–110	0,2	-0,025 / -0,035	1,5 %, mind. 1 μm	1	17,9	39	33	1,3 – 3,9		M10x1
4484401	844 D-FD	>110–120	0,2	-0,025 / -0,035	1,5 %, mind. 1 μm	1	17,9	39	33	1,3 – 3,9		M10x1
4484402	844 D-FD	>120–130	0,2	-0,025 / -0,035	1,5 %, mind. 1 μm	1	17,9	39	33	1,3 – 3,9		M10x1
4484403	844 D-FD	>130–140	0,2	-0,035 / -0,045	1,5 %, mind. 1 μm	1	17,9	39	33	1,3 – 3,9		M10x1
4484404	844 D-FD	>140–150	0,2	-0,035 / -0,045	1,5 %, mind. 1 μm	1	17,9	39	33	1,3 – 3,9		M10x1
4484405	844 D-FD	>150–160	0,2	-0,035 / -0,045	1,5 %, mind. 1 μm	1	17,9	39	33	1,3 – 3,9		M10x1
4484406	844 D-FD	>160–170	0,2	-0,035 / -0,045	1,5 %, mind. 1 μm	1	17,9	38,6	40	1,3 – 3,9		M10x1
4484407	844 D-FD	>170–180	0,2	-0,035 / -0,045	1,5 %, mind. 1 μm	1	17,9	38,6	40	1,3 – 3,9		M10x1
4484408	844 D-FD	>180–190	0,2	-0,035 / -0,045	1,5 %, mind. 1 μm	1	17,9	38,6	40	1,3 – 3,9		M10x1
4484409	844 D-FD	>190–200	0,2	-0,035 / -0,045	1,5 %, mind. 1 μm	1	17,9	37	40	1,3 – 3,9		M10x1

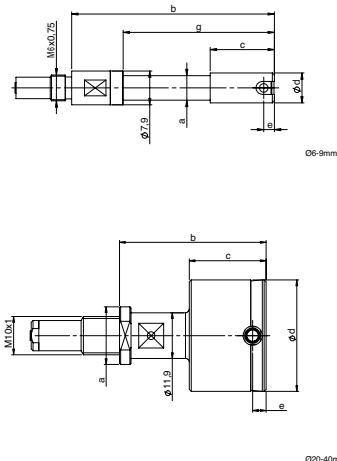

Marameter 844 DR-FD

Indicating plug gage

FEATURES

- The front distance "e" must be defined between dimension "e-min" and "e-max". **Please specify when ordering!**
- Measuring head has hard chrome plated cylinder guide and carbide-tipped anvils
- The carbide expanding pin transfers radial movement to indicating instrument
- Constant measuring force as a result of built-in spring, eliminating user influence
- Extensive modular system is composed of measuring head, holder, depth extension, right angle attachments and depth stops

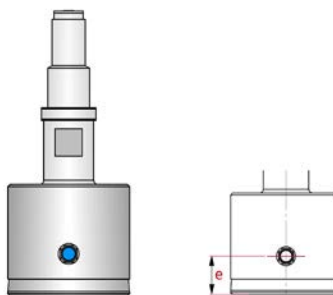

Application: Model for through holes, anvils with customer-specified location "e"
Reducing the guide cylinder to measure closer, or at a defined position, to the ground of the bore

- With extended guide cylinder for measuring through holes from the edge of the hole
- For rapid testing of diameter, roundness and conicity of bores
- Especially suitable for testing batches with tight tolerance zones
- Rocking in the bore is not required to determine diameter
- Ideal for use in conjunction with digital display units and for subsequent processing of measured values

TECHNICAL DATA

Order no.	Type	Measuring range	Measuring span	Manufacturing tolerance	Linearity deviation fe	Repeatability f _w	a	b	c	e	g	Connection thread
		mm	mm	mm / mm		µm	mm	mm	mm	mm	mm	
4484419	844 DR-FD	4-6	0,2	-0,015 / -0,025	1 %, mind. 1 µm	1	4	38	14,5	1,6	31,5	M6x0,75
4484420	844 DR-FD	>6-9	0,2	-0,015 / -0,025	1 %, mind. 1 µm	1	5,7	50,5	18,5	2,6	38,5	M6x0,75
4484421	844 DR-FD	>9-12	0,2	-0,015 / -0,025	1 %, mind. 1 µm	1	7,9	54,5	22,5	2,6	54,5	M6x0,75
4484422	844 DR-FD	>12-13	0,2	-0,015 / -0,025	1 %, mind. 1 µm	1	7,9	54,5	22,5	2,6	54,5	M6x0,75
4484423	844 DR-FD	>13-16	0,2	-0,015 / -0,025	1 %, mind. 1 µm	1	11,9	54,5	22,5	2,6	54,5	M6x0,75
4484424	844 DR-FD	>16-20	0,2	-0,015 / -0,025	1 %, mind. 1 µm	1	15	44,8	22,5	2,6		M10x1
4484425	844 DR-FD	>20-30	0,2	-0,02 / -0,03	1 %, mind. 1 µm	1	15	44,7	27	3,6		M10x1
4484426	844 DR-FD	>30-40	0,2	-0,02 / -0,03	1 %, mind. 1 µm	1	15	44,7	27	3,6		M10x1
4484427	844 DR-FD	>40-60	0,2	-0,02 / -0,03	1 %, mind. 1 µm	1	15	44,7	28	3,6		M10x1
4484428	844 DR-FD	>60-80	0,2	-0,025 / -0,035	1 %, mind. 1 µm	1	17,9	44,8	33	4,1		M10x1
4484429	844 DR-FD	>80-100	0,2	-0,025 / -0,035	1 %, mind. 1 µm	1	17,9	44,8	33	4,1		M10x1
4484430	844 DR-FD	>100-110	0,2	-0,025 / -0,035	1 %, mind. 1 µm	1	17,9	44,8	33	4,1		M10x1
4484431	844 DR-FD	>110-120	0,2	-0,025 / -0,035	1 %, mind. 1 µm	1	17,9	44,8	33	4,1		M10x1
4484432	844 DR-FD	>120-130	0,2	-0,025 / -0,035	1 %, mind. 1 µm	1	17,9	44,8	33	4,1		M10x1
4484433	844 DR-FD	>130-140	0,2	-0,035 / -0,045	1 %, mind. 1 µm	1	17,9	44,8	33	4,1		M10x1
4484434	844 DR-FD	>140-150	0,2	-0,035 / -0,045	1 %, mind. 1 µm	1	17,9	44,8	33	4,1		M10x1
4484435	844 DR-FD	>150-160	0,2	-0,035 / -0,045	1 %, mind. 1 µm	1	17,9	44,8	33	4,1		M10x1
4484436	844 DR-FD	>160-170	0,2	-0,035 / -0,045	1 %, mind. 1 µm	1	17,9	45	40	4,1		M10x1
4484437	844 DR-FD	>170-180	0,2	-0,035 / -0,045	1 %, mind. 1 µm	1	17,9	45	40	4,1		M10x1
4484438	844 DR-FD	>180-190	0,2	-0,035 / -0,045	1 %, mind. 1 µm	1	17,9	45	40	4,1		M10x1
4484439	844 DR-FD	>190-200	0,2	-0,035 / -0,045	1 %, mind. 1 µm	1	17,9	45	40	4,1		M10x1

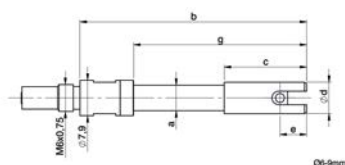

06-9mm

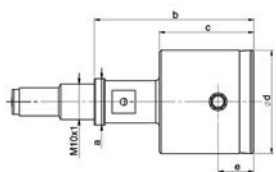

020-40mm

Marameter 844 D-M

Indicating plug gage

FEATURES

- Measuring head has a hard chrome plated cylinder guide and carbide-tipped anvils
- The carbide expanding pin transfers radial movement to indicating instrument
- Constant measuring force as a result of built-in spring, eliminating user influence
- Extensive modular system is composed of measuring head, holder, depth extension, right angle attachments and depth stops

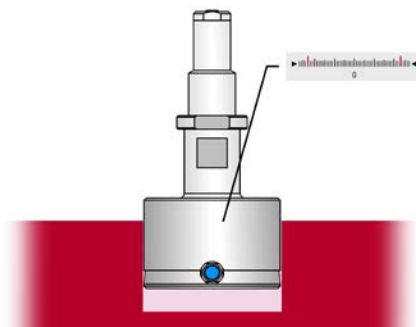

Application: Standard model, with extended measuring range

- For rapid testing of diameter, roundness and conicity of bores
- Especially suitable for testing batches with wide tolerance zones
- Rocking in the bore is not required to determine diameter
- Ideal for use in conjunction with digital display units and for subsequent processing of measured values

TECHNICAL DATA

Order no.	Type	Measuring range	Measuring span	Manu- facturing tolerance	Linearity deviation f _e	Repeatability f _w	a	b	c	e	g	Connection thread
		mm	mm	mm / mm		μm	mm	mm	mm	mm	mm	
4484448	844 D-M	3–4	0,4	–0,015 / –0,025	1 %, mind. 1 μm	1		33,5	24	1,5	24	M6x0,75
4484449	844 D-M	>4–6	0,4	–0,015 / –0,025	1 %, mind. 1 μm	1	4	33,5	10	1,5	27	M6x0,75
4484450	844 D-M	>6–9	0,6	–0,015 / –0,025	1 %, mind. 1 μm	1	5,7	47	15	2,5	35	M6x0,75
4484451	844 D-M	>9–12	0,6	–0,015 / –0,025	1 %, mind. 1 μm	1	7,9	47	15	2,5	47	M6x0,75
4484452	844 D-M	>12–13	0,6	–0,015 / –0,025	1 %, mind. 1 μm	1	7,9	47	15	2,5	47	M6x0,75
4484453	844 D-M	>13–16	0,6	–0,015 / –0,025	1 %, mind. 1 μm	1	11,9	47	15	2,5	47	M6x0,75
4484454	844 D-M	>16–20	0,6	–0,015 / –0,025	1 %, mind. 1 μm	1	15	37,3	15	2,5		M10x1
4484455	844 D-M	>20–30	0,6	–0,02 / –0,03	1 %, mind. 1 μm	1	15	38,2	20	3,5		M10x1
4484456	844 D-M	>30–40	0,6	–0,02 / –0,03	1 %, mind. 1 μm	1	15	38,2	20	3,5		M10x1
4484457	844 D-M	>40–60	0,6	–0,02 / –0,03	1 %, mind. 1 μm	1	15	38,2	28	3,5		M10x1
4484458	844 D-M	>60–80	0,6	–0,025 / –0,035	1 %, mind. 1 μm	1	17,9	38,8	33	4		M10x1
4484459	844 D-M	>80–100	0,6	–0,025 / –0,035	1 %, mind. 1 μm	1	17,9	38,8	33	4		M10x1
4484460	844 D-M	>100–110	0,6	–0,025 / –0,035	1 %, mind. 1 μm	1	17,9	38,8	33	4		M10x1
4484461	844 D-M	>110–120	0,6	–0,025 / –0,035	1 %, mind. 1 μm	1	17,9	38,8	33	4		M10x1
4484462	844 D-M	>120–130	0,6	–0,025 / –0,035	1 %, mind. 1 μm	1	17,9	38,8	33	4		M10x1
4484463	844 D-M	>130–140	0,6	–0,035 / –0,045	1 %, mind. 1 μm	1	17,9	38,8	33	4		M10x1
4484464	844 D-M	>140–150	0,6	–0,035 / –0,045	1 %, mind. 1 μm	1	17,9	38,8	33	4		M10x1
4484465	844 D-M	>150–160	0,6	–0,035 / –0,045	1 %, mind. 1 μm	1	17,9	38,8	33	4		M10x1
4484466	844 D-M	>160–170	0,6	–0,035 / –0,045	1 %, mind. 1 μm	1	17,9	39	40	4		M10x1
4484467	844 D-M	>170–180	0,6	–0,035 / –0,045	1 %, mind. 1 μm	1	17,9	39	40	4		M10x1
4484468	844 D-M	>180–190	0,6	–0,035 / –0,045	1 %, mind. 1 μm	1	17,9	39	40	4		M10x1
4484469	844 D-M	>190–200	0,6	–0,035 / –0,045	1 %, mind. 1 μm	1	17,9	39	40	4		M10x1

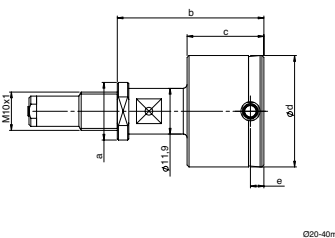
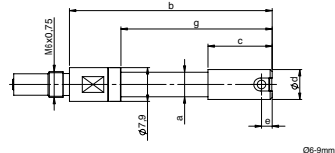

Marameter 844 DR-M

Indicating plug gage

FEATURES

- Measuring head has a hard chrome plated cylinder guide and carbide-tipped anvils
- The carbide expanding pin transfers radial movement to indicating instrument
- Constant measuring force as a result of built-in spring, eliminating user influence
- Extensive modular system is composed of measuring head, holder, depth extension, right angle attachments and depth stops

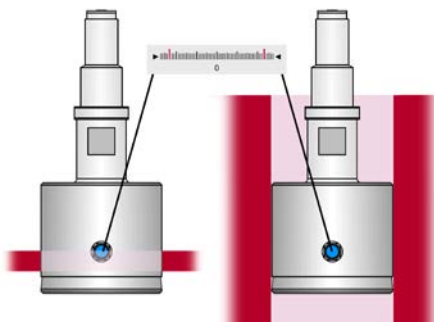

Application: Model for through holes, with extended measuring range

- With extended guide cylinder for measuring through holes from the edge of the hole
- For the rapid testing of diameter, roundness and conicity of bores
- Especially suitable for testing batches with wide tolerance zones
- Rocking in the bore is not required to determine diameter
- Ideal for use in conjunction with digital display units and for subsequent processing of measured values

TECHNICAL DATA

Order no.	Type	Measuring range	Measuring span	Manufacturing tolerance	Linearity deviation fe	Repeatability f _w	a	b	c	e	g	Connection thread
		mm	mm	mm / mm		µm	mm	mm	mm	mm	mm	
4484479	844 DR-M	4-6	0,4	-0,015 / -0,025	1 %, mind. 1 µm	1	4	38	14,5	6	31,5	M6x0,75
4484480	844 DR-M	>6-9	0,6	-0,015 / -0,025	1 %, mind. 1 µm	1	5,7	50,5	18,5	6	38,5	M6x0,75
4484481	844 DR-M	>9-12	0,6	-0,015 / -0,025	1 %, mind. 1 µm	1	7,9	54,5	22,5	10	54,5	M6x0,75
4484482	844 DR-M	>12-13	0,6	-0,015 / -0,025	1 %, mind. 1 µm	1	7,9	54,5	22,5	10	54,5	M6x0,75
4484483	844 DR-M	>13-16	0,6	-0,015 / -0,025	1 %, mind. 1 µm	1	11,9	54,5	22,5	10	54,5	M6x0,75
4484484	844 DR-M	>16-20	0,6	-0,015 / -0,025	1 %, mind. 1 µm	1	15	44,8	22,5	10		M10x1
4484485	844 DR-M	>20-30	0,6	-0,02 / -0,03	1 %, mind. 1 µm	1	15	44,7	27	10		M10x1
4484486	844 DR-M	>30-40	0,6	-0,02 / -0,03	1 %, mind. 1 µm	1	15	44,7	27	10		M10x1
4484487	844 DR-M	>40-60	0,6	-0,02 / -0,03	1 %, mind. 1 µm	1	15	44,7	28	10		M10x1
4484488	844 DR-M	>60-80	0,6	-0,025 / -0,035	1 %, mind. 1 µm	1	17,9	44,8	33	10		M10x1
4484489	844 DR-M	>80-100	0,6	-0,025 / -0,035	1 %, mind. 1 µm	1	17,9	44,8	33	10		M10x1
4484490	844 DR-M	>100-110	0,6	-0,025 / -0,035	1 %, mind. 1 µm	1	17,9	44,8	33	10		M10x1
4484491	844 DR-M	>110-120	0,6	-0,025 / -0,035	1 %, mind. 1 µm	1	17,9	44,8	33	10		M10x1
4484492	844 DR-M	>120-130	0,6	-0,025 / -0,035	1 %, mind. 1 µm	1	17,9	44,8	33	10		M10x1
4484493	844 DR-M	>130-140	0,6	-0,035 / -0,045	1 %, mind. 1 µm	1	17,9	44,8	33	10		M10x1
4484494	844 DR-M	>140-150	0,6	-0,035 / -0,045	1 %, mind. 1 µm	1	17,9	44,8	33	10		M10x1
4484495	844 DR-M	>150-160	0,6	-0,035 / -0,045	1 %, mind. 1 µm	1	17,9	44,8	33	10		M10x1
4484496	844 DR-M	>160-170	0,6	-0,035 / -0,045	1 %, mind. 1 µm	1	17,9	45	40	10		M10x1
4484497	844 DR-M	>170-180	0,6	-0,035 / -0,045	1 %, mind. 1 µm	1	17,9	45	40	10		M10x1
4484498	844 DR-M	>180-190	0,6	-0,035 / -0,045	1 %, mind. 1 µm	1	17,9	45	40	10		M10x1
4484499	844 DR-M	>190-200	0,6	-0,035 / -0,045	1 %, mind. 1 µm	1	17,9	45	40	10		M10x1

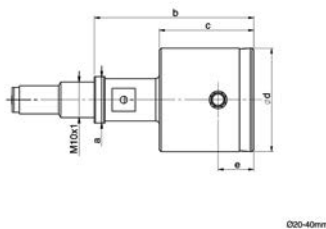
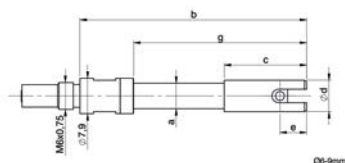

Marameter 844 DS-M

Indicating plug gage

FEATURES

- Measuring head made of hardened, hard chrome-plated guide cylinder and carbide-tipped measuring probes
- Carbide driving needle transfers radial measuring movement to the display unit
- Constant measuring force thanks to inbuilt measuring force spring. Measuring results are therefore independent of personal sense of touch
- Measuring head, measuring instrument holder, depth extensions, right-angle attachments, and depth stops form a comprehensive modular system
- To protect the measuring contacts during entry into the hole the use of a holder with lifter (844 Kga or 844 Dga) is recommended

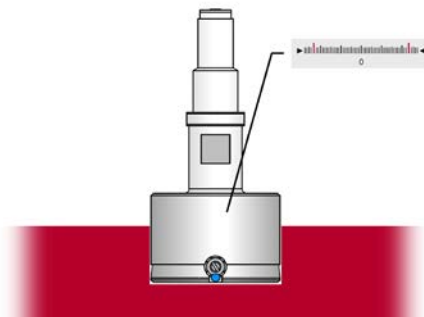

Application: Model for blind holes, with extended measuring range

Recommendation: To protect the measuring contacts, when inserting them into the bore, the use of a holder with lifting device (844 Kga or 844 Dga) is recommended.

- For measurements close to the base of the hole
- For the rapid testing of diameter, roundness and conicity of bores
- Especially suitable for testing batches with wide tolerance zones
- Rocking in the bore is not required to determine diameter
- Ideal for use in conjunction with digital display units and for subsequent processing of measured values

TECHNICAL DATA

Order no.	Type	Measuring range	Measuring span	Manufacturing tolerance	Linearity deviation f_e	Repeatability f_w	a	b	c	e	g	Connection thread
4484508	844 DS-M	3–4	0,4	-0,015 / -0,025	1,5 %, mind. 1 μ m	1		33	23,5	1	23,5	M6x0,75
4484509	844 DS-M	>4–6	0,4	-0,015 / -0,025	1,5 %, mind. 1 μ m	1	4	33	9,5	1	26,5	M6x0,75
4484510	844 DS-M	>6–9	0,6	-0,015 / -0,025	1,5 %, mind. 1 μ m	1	5,7	45,5	13,5	1	33,5	M6x0,75
4484511	844 DS-M	>9–12	0,6	-0,015 / -0,025	1,5 %, mind. 1 μ m	1	7,9	45,5	13,5	1	45,5	M6x0,75
4484512	844 DS-M	>12–13	0,6	-0,015 / -0,025	1,5 %, mind. 1 μ m	1	7,9	45,5	13,5	1	45,5	M6x0,75
4484513	844 DS-M	>13–16	0,6	-0,015 / -0,025	1,5 %, mind. 1 μ m	1	11,9	45,5	13,5	1	45,5	M6x0,75
4484514	844 DS-M	>16–20	0,6	-0,015 / -0,025	1,5 %, mind. 1 μ m	1	15	35,8	13,5	1		M10x1
4484515	844 DS-M	>20–30	0,6	-0,02 / -0,03	1,5 %, mind. 1 μ m	1	15	38,2	20	1,2		M10x1
4484516	844 DS-M	>30–40	0,6	-0,02 / -0,03	1,5 %, mind. 1 μ m	1	15	38,2	20	1,2		M10x1
4484517	844 DS-M	>40–60	0,6	-0,02 / -0,03	1,5 %, mind. 1 μ m	1	15	38,2	28	1,2		M10x1
4484518	844 DS-M	>60–80	0,6	-0,025 / -0,035	1,5 %, mind. 1 μ m	1	17,9	39	33	1,2		M10x1
4484519	844 DS-M	>80–100	0,6	-0,025 / -0,035	1,5 %, mind. 1 μ m	1	17,9	39	33	1,2		M10x1
4484520	844 DS-M	>100–110	0,6	-0,025 / -0,035	1,5 %, mind. 1 μ m	1	17,9	39	33	1,2		M10x1
4484521	844 DS-M	>110–120	0,6	-0,025 / -0,035	1,5 %, mind. 1 μ m	1	17,9	39	33	1,2		M10x1
4484522	844 DS-M	>120–130	0,6	-0,025 / -0,035	1,5 %, mind. 1 μ m	1	17,9	39	33	1,2		M10x1
4484523	844 DS-M	>130–140	0,6	-0,035 / -0,045	1,5 %, mind. 1 μ m	1	17,9	39	33	1,2		M10x1
4484524	844 DS-M	>140–150	0,6	-0,035 / -0,045	1,5 %, mind. 1 μ m	1	17,9	39	33	1,2		M10x1
4484525	844 DS-M	>150–160	0,6	-0,035 / -0,045	1,5 %, mind. 1 μ m	1	17,9	39	33	1,2		M10x1
4484526	844 DS-M	>160–170	0,6	-0,035 / -0,045	1,5 %, mind. 1 μ m	1	17,9	38,6	40	1,2		M10x1
4484527	844 DS-M	>170–180	0,6	-0,035 / -0,045	1,5 %, mind. 1 μ m	1	17,9	38,6	40	1,2		M10x1
4484528	844 DS-M	>180–190	0,6	-0,035 / -0,045	1,5 %, mind. 1 μ m	1	17,9	38,6	40	1,2		M10x1
4484529	844 DS-M	>190–200	0,6	-0,035 / -0,045	1,5 %, mind. 1 μ m	1	17,9	38,6	40	1,2		M10x1

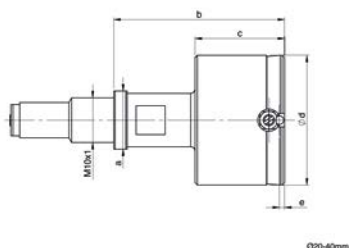
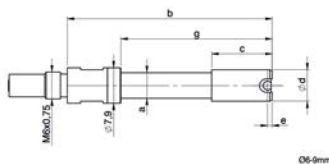

Marameter 844 D-HR

Indicating plug gage

FEATURES

- Measuring head has a hard chrome plated cylinder guide and carbide-tipped anvils
- The carbide expanding pin transfers radial movement to indicating instrument
- Constant measuring force as a result of built-in spring, eliminating user influence
- Extensive modular system is composed of measuring head, holder, depth extension, right angle attachments and depth stops

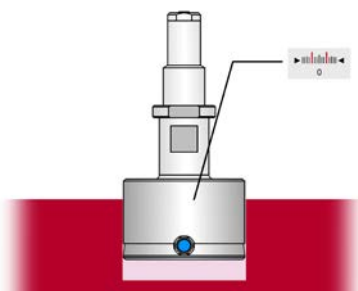

Application: Standard version for very tight tolerance fields less than 10 µm

Manufacturing tolerance of the guide cylinder reduced to 0.01 mm ($\pm 5 \mu\text{m}$) to reduce the axial and radial measuring influences

- For the rapid testing of diameter, roundness and conicity of bores
- Ideal for testing batches with very tight tolerance fields less than 10 µm
- Rocking in the bore is not required to determine diameter
- Therefore ideal for use in conjunction with digital display units and for subsequent processing of measured values

TECHNICAL DATA

Order no.	Type	Measuring range	Measuring span	Manufacturing tolerance	Linearity deviation f_e	Repeatability f_w	a	b	c	e	g	Connection thread
		mm	mm	mm / mm		μm	mm	mm	mm	mm	mm	
4484538	844 D-HR	3–4	0,2	-0,005 / -0,015	1 %, mind. 1 µm	1		33,5	24	1,5	24	M6x0,75
4484539	844 D-HR	>4–6	0,2	-0,005 / -0,015	1 %, mind. 1 µm	1	4	33,5	10	1,5	27	M6x0,75
4484540	844 D-HR	>6–9	0,2	-0,005 / -0,015	1 %, mind. 1 µm	1	5,7	47	15	2,5	35	M6x0,75
4484541	844 D-HR	>9–12	0,2	-0,005 / -0,015	1 %, mind. 1 µm	1	7,9	47	15	2,5	47	M6x0,75
4484542	844 D-HR	>12–13	0,2	-0,005 / -0,015	1 %, mind. 1 µm	1	7,9	47	15	2,5	47	M6x0,75
4484543	844 D-HR	>13–16	0,2	-0,005 / -0,015	1 %, mind. 1 µm	1	11,9	47	15	2,5	47	M6x0,75
4484544	844 D-HR	>16–20	0,2	-0,005 / -0,015	1 %, mind. 1 µm	1	15	37,3	15	2,5		M10x1
4484545	844 D-HR	>20–30	0,2	-0,01 / -0,02	1 %, mind. 1 µm	1	15	38,2	20	3,5		M10x1
4484546	844 D-HR	>30–40	0,2	-0,01 / -0,02	1 %, mind. 1 µm	1	15	38,2	20	3,5		M10x1
4484547	844 D-HR	>40–60	0,2	-0,01 / -0,02	1 %, mind. 1 µm	1	15	38,2	28	3,5		M10x1
4484548	844 D-HR	>60–80	0,2	-0,015 / -0,025	1 %, mind. 1 µm	1	17,9	38,8	33	4		M10x1
4484549	844 D-HR	>80–100	0,2	-0,015 / -0,025	1 %, mind. 1 µm	1	17,9	38,8	33	4		M10x1
4484550	844 D-HR	>100–110	0,2	-0,015 / -0,025	1 %, mind. 1 µm	1	17,9	38,8	33	4		M10x1
4484551	844 D-HR	>110–120	0,2	-0,015 / -0,025	1 %, mind. 1 µm	1	17,9	38,8	33	4		M10x1
4484552	844 D-HR	>120–130	0,2	-0,015 / -0,025	1 %, mind. 1 µm	1	17,9	38,8	33	4		M10x1
4484553	844 D-HR	>130–140	0,2	-0,025 / -0,035	1 %, mind. 1 µm	1	17,9	38,8	33	4		M10x1
4484554	844 D-HR	>140–150	0,2	-0,025 / -0,035	1 %, mind. 1 µm	1	17,9	38,8	33	4		M10x1
4484555	844 D-HR	>150–160	0,2	-0,025 / -0,035	1 %, mind. 1 µm	1	17,9	38,8	33	4		M10x1
4484556	844 D-HR	>160–170	0,2	-0,025 / -0,035	1 %, mind. 1 µm	1	17,9	39	40	4		M10x1
4484557	844 D-HR	>170–180	0,2	-0,025 / -0,035	1 %, mind. 1 µm	1	17,9	39	40	4		M10x1
4484558	844 D-HR	>180–190	0,2	-0,025 / -0,035	1 %, mind. 1 µm	1	17,9	39	40	4		M10x1
4484559	844 D-HR	>190–200	0,2	-0,025 / -0,035	1 %, mind. 1 µm	1	17,9	39	40	4		M10x1

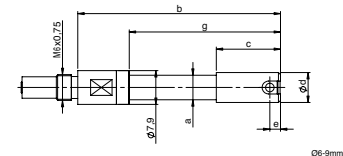

06-9mm

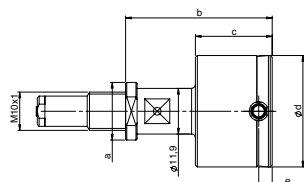

020-40mm

Marameter 844 DR-HR

Indicating plug gage

FEATURES

- Measuring head has a hard chrome plated cylinder guide and carbide-tipped anvils
- The carbide expanding pin transfers radial movement to indicating instrument
- Constant measuring force as a result of built-in spring, eliminating user influence
- Extensive modular system is composed of measuring head, holder, depth extension, right angle attachments and depth stops

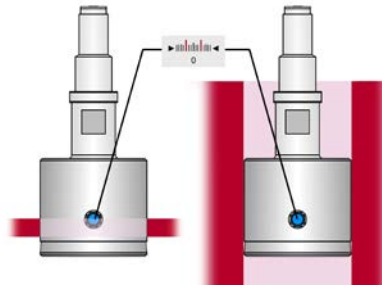

Application: Model for through holes, for very tight tolerance fields less than 10 µm

Manufacturing tolerance of the guide cylinder reduced to 0.01 mm (±5 µm) to reduce the axial and radial measuring influences

- With extended guide cylinder for measuring through holes from the edge of the hole
- For the rapid testing of diameter, roundness and conicity of bores
- Ideal for testing batches with very tight tolerance fields less than 10 µm
- Rocking in the bore is not required to determine diameter
- Therefore ideal for use in conjunction with digital display units and for subsequent processing of measured values

TECHNICAL DATA

Order no.	Type	Measuring range	Measuring span	Manufacturing tolerance	Linearity deviation fe	Repeatability f _w	a	b	c	e	g	Connection thread
		mm	mm	mm / mm	1 %, mind. 1 µm	µm	mm	mm	mm	mm	mm	
4484569	844 DR-HR	4–6	0,2	–0,005 / –0,015	1 %, mind. 1 µm	1	4	38	14,5	6	31,5	M6x0,75
4484570	844 DR-HR	>6–9	0,2	–0,005 / –0,015	1 %, mind. 1 µm	1	5,7	50,5	18,5	6	38,5	M6x0,75
4484571	844 DR-HR	>9–12	0,2	–0,005 / –0,015	1 %, mind. 1 µm	1	7,9	54,5	22,5	10	54,5	M6x0,75
4484572	844 DR-HR	>12–13	0,2	–0,005 / –0,015	1 %, mind. 1 µm	1	7,9	54,5	22,5	10	54,5	M6x0,75
4484573	844 DR-HR	>13–16	0,2	–0,005 / –0,015	1 %, mind. 1 µm	1	11,9	54,5	22,5	10	54,5	M6x0,75
4484574	844 DR-HR	>16–20	0,2	–0,005 / –0,015	1 %, mind. 1 µm	1	15	44,8	22,5	10		M10x1
4484575	844 DR-HR	>20–30	0,2	–0,01 / –0,02	1 %, mind. 1 µm	1	15	44,7	27	10		M10x1
4484576	844 DR-HR	>30–40	0,2	–0,01 / –0,02	1 %, mind. 1 µm	1	15	44,7	27	10		M10x1
4484577	844 DR-HR	>40–60	0,2	–0,01 / –0,02	1 %, mind. 1 µm	1	15	44,7	28	10		M10x1
4484578	844 DR-HR	>60–80	0,2	–0,015 / –0,025	1 %, mind. 1 µm	1	17,9	44,8	33	10		M10x1
4484579	844 DR-HR	>80–100	0,2	–0,015 / –0,025	1 %, mind. 1 µm	1	17,9	44,8	33	10		M10x1
4484580	844 DR-HR	>100–110	0,2	–0,015 / –0,025	1 %, mind. 1 µm	1	17,9	44,8	33	10		M10x1
4484581	844 DR-HR	>110–120	0,2	–0,015 / –0,025	1 %, mind. 1 µm	1	17,9	44,8	33	10		M10x1
4484582	844 DR-HR	>120–130	0,2	–0,015 / –0,025	1 %, mind. 1 µm	1	17,9	44,8	33	10		M10x1
4484583	844 DR-HR	>130–140	0,2	–0,025 / –0,035	1 %, mind. 1 µm	1	17,9	44,8	33	10		M10x1
4484584	844 DR-HR	>140–150	0,2	–0,025 / –0,035	1 %, mind. 1 µm	1	17,9	44,8	33	10		M10x1
4484585	844 DR-HR	>150–160	0,2	–0,025 / –0,035	1 %, mind. 1 µm	1	17,9	44,8	33	10		M10x1
4484586	844 DR-HR	>160–170	0,2	–0,025 / –0,035	1 %, mind. 1 µm	1	17,9	45	40	10		M10x1
4484587	844 DR-HR	>170–180	0,2	–0,025 / –0,035	1 %, mind. 1 µm	1	17,9	45	40	10		M10x1
4484588	844 DR-HR	>180–190	0,2	–0,025 / –0,035	1 %, mind. 1 µm	1	17,9	45	40	10		M10x1
4484589	844 DR-HR	>190–200	0,2	–0,025 / –0,035	1 %, mind. 1 µm	1	17,9	45	40	10		M10x1

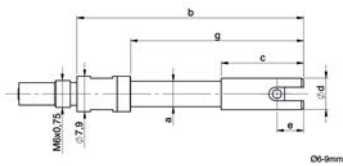

00-99.999mm

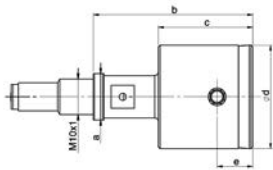

020-400mm

Marameter 844 DS-HR

Indicating plug gage

FEATURES

- Measuring head has a hard chrome plated cylinder guide and carbide-tipped anvils
- The carbide expanding pin transfers radial movement to indicating instrument
- Constant measuring force as a result of built-in spring, eliminating user influence
- Extensive modular system is composed of measuring head, holder, depth extension, right angle attachments and depth stops

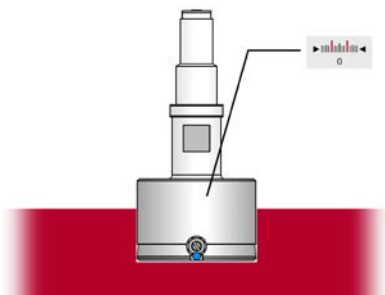

Application: Model for blind holes, for very tight tolerance fields less than 10 µm

Manufacturing tolerance of the guide cylinder reduced to 0.01 mm ($\pm 5 \mu\text{m}$) to reduce the axial and radial measuring influences

- For measurements close to the base of the hole
- For the rapid testing of diameter, roundness and conicity of bores
- Ideal for testing batches with very tight tolerance fields less than 10 µm
- Rocking in the bore is not required to determine diameter
- Therefore ideal for use in conjunction with digital display units and for subsequent processing of measured values

TECHNICAL DATA

Order no.	Type	Measuring range	Measuring span	Manufacturing tolerance	Linearity deviation fe	Repeatability f_w	a	b	c	e	g	Connection thread
		mm	mm	mm / mm		μm	mm	mm	mm	mm	mm	
4484598	844 DS-HR	3–4	0,2	-0,005 / -0,015	1,5 %, mind. 1 µm	1		33	23,5	1	23,5	M6x0,75
4484599	844 DS-HR	>4–6	0,2	-0,005 / -0,015	1,5 %, mind. 1 µm	1	4	33	9,5	1	26,5	M6x0,75
4484600	844 DS-HR	>6–9	0,2	-0,005 / -0,015	1,5 %, mind. 1 µm	1	5,7	45,5	13,5	1	33,5	M6x0,75
4484601	844 DS-HR	>9–12	0,2	-0,005 / -0,015	1,5 %, mind. 1 µm	1	7,9	45,5	13,5	1	45,5	M6x0,75
4484602	844 DS-HR	>12–13	0,2	-0,005 / -0,015	1,5 %, mind. 1 µm	1	7,9	45,5	13,5	1	45,5	M6x0,75
4484603	844 DS-HR	>13–16	0,2	-0,005 / -0,015	1,5 %, mind. 1 µm	1	11,9	45,5	13,5	1	45,5	M6x0,75
4484604	844 DS-HR	>16–20	0,2	-0,005 / -0,015	1,5 %, mind. 1 µm	1	15	35,8	13,5	1		M10x1
4484605	844 DS-HR	>20–30	0,2	-0,01 / -0,02	1,5 %, mind. 1 µm	1	15	38,2	20	1,2		M10x1
4484606	844 DS-HR	>30–40	0,2	-0,01 / -0,02	1,5 %, mind. 1 µm	1	15	38,2	20	1,2		M10x1
4484607	844 DS-HR	>40–60	0,2	-0,01 / -0,02	1,5 %, mind. 1 µm	1	15	38,2	28	1,2		M10x1
4484608	844 DS-HR	>60–80	0,2	-0,015 / -0,025	1,5 %, mind. 1 µm	1	17,9	39	33	1,2		M10x1
4484609	844 DS-HR	>80–100	0,2	-0,015 / -0,025	1,5 %, mind. 1 µm	1	17,9	39	33	1,2		M10x1
4484610	844 DS-HR	>100–110	0,2	-0,015 / -0,025	1,5 %, mind. 1 µm	1	17,9	39	33	1,2		M10x1
4484611	844 DS-HR	>110–120	0,2	-0,015 / -0,025	1,5 %, mind. 1 µm	1	17,9	39	33	1,2		M10x1
4484612	844 DS-HR	>120–130	0,2	-0,015 / -0,025	1,5 %, mind. 1 µm	1	17,9	39	33	1,2		M10x1
4484613	844 DS-HR	>130–140	0,2	-0,025 / -0,035	1,5 %, mind. 1 µm	1	17,9	39	33	1,2		M10x1
4484614	844 DS-HR	>140–150	0,2	-0,025 / -0,035	1,5 %, mind. 1 µm	1	17,9	39	33	1,2		M10x1
4484615	844 DS-HR	>150–160	0,2	-0,025 / -0,035	1,5 %, mind. 1 µm	1	17,9	39	33	1,2		M10x1
4484616	844 DS-HR	>160–170	0,2	-0,025 / -0,035	1,5 %, mind. 1 µm	1	17,9	38,6	40	1,2		M10x1
4484617	844 DS-HR	>170–180	0,2	-0,025 / -0,035	1,5 %, mind. 1 µm	1	17,9	38,6	40	1,2		M10x1
4484618	844 DS-HR	>180–190	0,2	-0,025 / -0,035	1,5 %, mind. 1 µm	1	17,9	38,6	40	1,2		M10x1
4484619	844 DS-HR	>190–200	0,2	-0,025 / -0,035	1,5 %, mind. 1 µm	1	17,9	38,6	40	1,2		M10x1

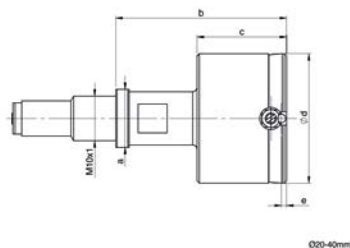
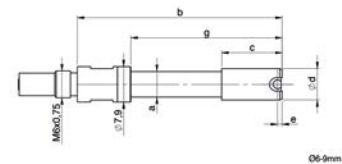

Marameter 844 DS-F

Indicating plug gage

FEATURES

- Measuring head has a hard chrome plated cylinder guide and carbide-tipped anvils
- The carbide expanding pin transfers radial movement to indicating instrument
- Constant measuring force as a result of built-in spring, eliminating user influence
- Extensive modular system is composed of measuring head, holder, depth extension, right angle attachments and depth stops

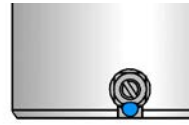
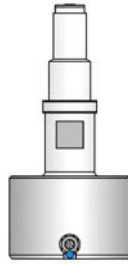

Application: Model for blind holes, with front chamfer
For measuring very short bores

- For measurements close to the base of the hole
- For rapid testing of diameter, roundness and conicity of bores
- Especially suitable for testing batches with tight tolerance zones
- Rocking in the bore is not required to determine diameter
- Ideal for use in conjunction with digital display units and for subsequent processing of measured values

TECHNICAL DATA

Order no.	Type	Measuring range	Measuring span	Manufacturing tolerance	Linearity deviation f_e	Repeatability f_w	a	b	c	e	g	Connection thread
		mm	mm	mm / mm		μm	mm	mm	mm	mm	mm	
4484627	844 DS-F	2–2,999	0,15	–0,015 / –0,025	1,5 %, mind. 1 μm	1		20,7	14,2	0,7	14,2	M6x0,75
4484628	844 DS-F	3–4	0,2	–0,015 / –0,025	1,5 %, mind. 1 μm	1		33	23,5	1	23,5	M6x0,75
4484629	844 DS-F	>4–6	0,2	–0,015 / –0,025	1,5 %, mind. 1 μm	1	4	33	9,5	1	26,5	M6x0,75
4484630	844 DS-F	>6–9	0,2	–0,015 / –0,025	1,5 %, mind. 1 μm	1	5,7	45,5	13,5	1	33,5	M6x0,75
4484631	844 DS-F	>9–12	0,2	–0,015 / –0,025	1,5 %, mind. 1 μm	1	7,9	45,5	13,5	1	45,5	M6x0,75
4484632	844 DS-F	>12–13	0,2	–0,015 / –0,025	1,5 %, mind. 1 μm	1	7,9	45,5	13,5	1	45,5	M6x0,75
4484633	844 DS-F	>13–16	0,2	–0,015 / –0,025	1,5 %, mind. 1 μm	1	11,9	45,5	13,5	1	45,5	M6x0,75
4484634	844 DS-F	>16–20	0,2	–0,015 / –0,025	1,5 %, mind. 1 μm	1	15	35,8	13,5	1		M10x1
4484635	844 DS-F	>20–30	0,2	–0,02 / –0,03	1,5 %, mind. 1 μm	1	15	38,2	20	1,2		M10x1
4484636	844 DS-F	>30–40	0,2	–0,02 / –0,03	1,5 %, mind. 1 μm	1	15	38,2	20	1,2		M10x1
4484637	844 DS-F	>40–60	0,2	–0,02 / –0,03	1,5 %, mind. 1 μm	1	15	38,2	28	1,2		M10x1
4484638	844 DS-F	>60–80	0,2	–0,025 / –0,035	1,5 %, mind. 1 μm	1	17,9	39	33	1,2		M10x1
4484639	844 DS-F	>80–100	0,2	–0,025 / –0,035	1,5 %, mind. 1 μm	1	17,9	39	33	1,2		M10x1
4484640	844 DS-F	>100–110	0,2	–0,025 / –0,035	1,5 %, mind. 1 μm	1	17,9	39	33	1,2		M10x1
4484641	844 DS-F	>110–120	0,2	–0,025 / –0,035	1,5 %, mind. 1 μm	1	17,9	39	33	1,2		M10x1
4484642	844 DS-F	>120–130	0,2	–0,025 / –0,035	1,5 %, mind. 1 μm	1	17,9	39	33	1,2		M10x1
4484643	844 DS-F	>130–140	0,2	–0,035 / –0,045	1,5 %, mind. 1 μm	1	17,9	39	33	1,2		M10x1
4484644	844 DS-F	>140–150	0,2	–0,035 / –0,045	1,5 %, mind. 1 μm	1	17,9	39	33	1,2		M10x1
4484645	844 DS-F	>150–160	0,2	–0,035 / –0,045	1,5 %, mind. 1 μm	1	17,9	39	33	1,2		M10x1
4484646	844 DS-F	>160–170	0,2	–0,035 / –0,045	1,5 %, mind. 1 μm	1	17,9	38,6	40	1,2		M10x1
4484647	844 DS-F	>170–180	0,2	–0,035 / –0,045	1,5 %, mind. 1 μm	1	17,9	38,6	40	1,2		M10x1
4484648	844 DS-F	>180–190	0,2	–0,035 / –0,045	1,5 %, mind. 1 μm	1	17,9	38,6	40	1,2		M10x1
4484649	844 DS-F	>190–200	0,2	–0,035 / –0,045	1,5 %, mind. 1 μm	1	17,9	38,6	40	1,2		M10x1

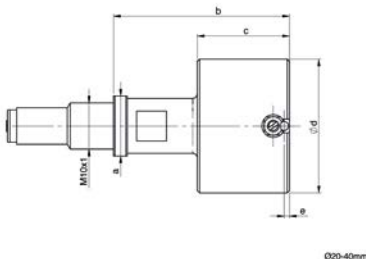

Marameter 844 D-3

Indicating plug gage

FEATURES

- Measuring head has hard chrome plated cylinder guide and carbide-tipped anvils (spaced at 3 x 120°)
- The carbide expanding pin transfers radial movement to indicating instrument
- Constant measuring force as a result of built-in spring, eliminating user influence
- Extensive modular system is composed of measuring head, holder, depth extension, right angle attachments and depth stops

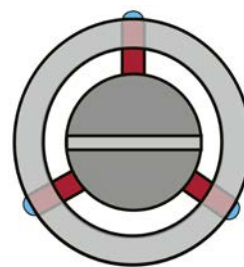
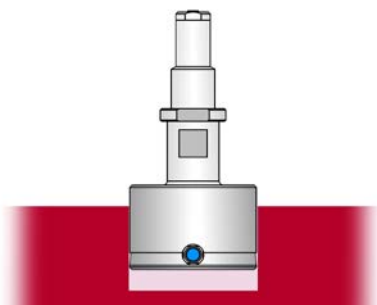

Application: Standard model, with 3-point contact (gaging contacts spaced 3 x 120°)
For fast measurement of interrupted diameters and detection of form deviations in a polygon

- Especially suitable for testing batches with tight tolerance zones
- Rocking in the bore is not required to determine diameter
- Ideal for use in conjunction with digital display units and for subsequent processing of measured values

TECHNICAL DATA

Order no.	Type	Measuring range	Measuring span	Manufacturing tolerance	Linearity deviation fe	Repeatability f _w	a	b	c	e	g	Connection thread
		mm	mm	mm / mm		μm	mm	mm	mm	mm	mm	
4484659	844 D-3	4-6	0,2	-0,015 / -0,025	2 %, mind. 1 μm	1	4	33,5	10	1,5	23,5	M6x0,75
4484660	844 D-3	>6-9	0,2	-0,015 / -0,025	2 %, mind. 1 μm	1	5,7	47	15	2,5	26,5	M6x0,75
4484661	844 D-3	>9-12	0,2	-0,015 / -0,025	2 %, mind. 1 μm	1	7,9	47	15	2,5	33,5	M6x0,75
4484662	844 D-3	>12-13	0,2	-0,015 / -0,025	2 %, mind. 1 μm	1	7,9	47	15	2,5	45,5	M6x0,75
4484663	844 D-3	>13-16	0,2	-0,015 / -0,025	2 %, mind. 1 μm	1	11,9	47	15	2,5	45,5	M6x0,75
4484664	844 D-3	>16-20	0,2	-0,015 / -0,025	2 %, mind. 1 μm	1	15	37	15	2,5	45,5	M10x1
4484665	844 D-3	>20-30	0,2	-0,02 / -0,03	2 %, mind. 1 μm	1	15	38,2	20	3,5		M10x1
4484666	844 D-3	>30-40	0,2	-0,02 / -0,03	2 %, mind. 1 μm	1	15	38,2	20	3,5		M10x1
4484667	844 D-3	>40-60	0,2	-0,02 / -0,03	2 %, mind. 1 μm	1	15	38,2	28	3,5		M10x1
4484668	844 D-3	>60-80	0,2	-0,025 / -0,035	2 %, mind. 1 μm	1	17,9	38,8	33	4		M10x1
4484669	844 D-3	>80-100	0,2	-0,025 / -0,035	2 %, mind. 1 μm	1	17,9	38,8	33	4		M10x1

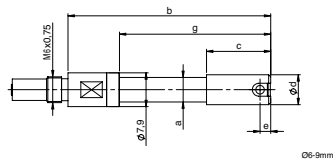

Ø6-9mm

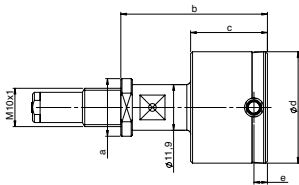

Ø20-40mm

Marameter 844 DR-3

Indicating plug gage

FEATURES

- Measuring head has hard chrome plated cylinder guide and carbide-tipped anvils (spaced at $3 \times 120^\circ$)
- The carbide expanding pin transfers radial movement to indicating instrument
- Constant measuring force as a result of built-in spring, eliminating user influence
- Extensive modular system is composed of measuring head, holder, depth extension, right angle attachments and depth stops

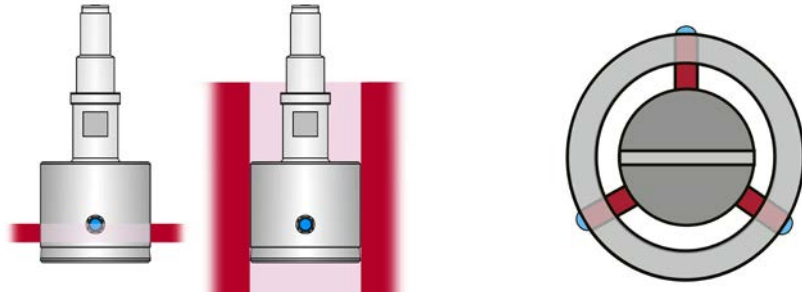

Application: Model for through holes, with 3-point contact (gaging contacts spaced $3 \times 120^\circ$)
For fast measurement of interrupted diameters and detection of form deviations in a polygon

- Especially suitable for testing batches with tight tolerance zones
- Rocking in the bore is not required to determine diameter
- Ideal for use in conjunction with digital display units and for subsequent processing of measured values

TECHNICAL DATA

Order no.	Type	Measuring range	Measuring span	Manu- facturing tolerance	Linearity deviation f_e	Repeatability f_w	a	b	c	e	g	Connection thread
4484689	844 DR-3	4-6	0,2	-0,015 / -0,025	2 %, mind. 1 μm	1	4	38	14,5	6	23,5	M6x0,75
4484690	844 DR-3	>6-9	0,2	-0,015 / -0,025	2 %, mind. 1 μm	1	5,7	50,5	18,5	6	26,5	M6x0,75
4484691	844 DR-3	>9-12	0,2	-0,015 / -0,025	2 %, mind. 1 μm	1	7,9	54,5	22,5	10	33,5	M6x0,75
4484692	844 DR-3	>12-13	0,2	-0,015 / -0,025	2 %, mind. 1 μm	1	7,9	54,5	22,5	10	45,5	M6x0,75
4484693	844 DR-3	>13-16	0,2	-0,015 / -0,025	2 %, mind. 1 μm	1	11,9	54,5	22,5	10	45,5	M6x0,75
4484694	844 DR-3	>16-20	0,2	-0,015 / -0,025	2 %, mind. 1 μm	1	15	44,6	22,5	10	45,5	M10x1
4484695	844 DR-3	>20-30	0,2	-0,02 / -0,03	2 %, mind. 1 μm	1	15	44,7	27	10		M10x1
4484696	844 DR-3	>30-40	0,2	-0,02 / -0,03	2 %, mind. 1 μm	1	15	44,7	27	10		M10x1
4484697	844 DR-3	>40-60	0,2	-0,02 / -0,03	2 %, mind. 1 μm	1	15	44,7	28	10		M10x1
4484698	844 DR-3	>60-80	0,2	-0,025 / -0,035	2 %, mind. 1 μm	1	17,9	44,8	33	10		M10x1
4484699	844 DR-3	>80-100	0,2	-0,025 / -0,035	2 %, mind. 1 μm	1	17,9	44,8	33	10		M10x1

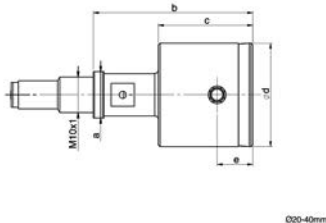
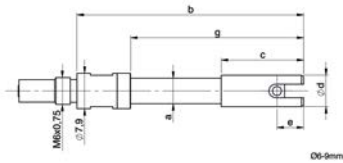

Marameter 844 Dgk / 844 Dga / 844 Dg / 844 Dg-XL

Holder for Plug Gage

FEATURES

The measuring instrument holder comprises a handle with a transfer rod, other properties:

- Holder for upper cylinder shaft Ø8 mm, for display unit e.g. dial comparator or digital dial indicator
- Lower connecting thread to hold a bore plug gage 844 D / 844 DR / 844 DS



Application:

Type 844 Dga: Special design with retraction button, advantageous e.g. for sensitive workpieces for easier insertion of a plug gage in blind hole design 844 DS. We recommend it for small and sensitive bores.

Type 844 Dg-XL: Heavy duty and stable design for large plug gages (possible from Ø 60 mm), especially when using measuring depth extensions 844 Dv (Ø 18 mm) for large measuring depths.

TECHNICAL DATA

Order no.	Type	Mount Ø	Design	Dimension L	Connection thread
		mm		mm	
4484750	844 Dgk	8 mm	short design	59	M10 x 1
4484751	844 Dga	8 mm	with retract button	83	M10 x 1
4484752	844 Dg	8 mm	standard design	109	M6 x 0,75
4484753	844 Dg	8 mm	standard design	109	M10 x 1
4484754	844 Dg	8 mm	standard design	239	M6 x 0,75
4484755	844 Dg	8 mm	Standard design	249	M10 x 1
4484756	844 Dg-XL	8 mm	extra stable design	154	M10 x 1
4484757	844 Dg-XL	8 mm	extra stable design	244	M10 x 1
4484758	844 Dgk-Z	3/8"	standard design	59	M10 x 1
4484759	844 Dg-Z	3/8"	short design	109	M10 x 1

Order no.	Dimension L	d1	d2	l	Mount Ø
	mm	mm	mm	mm	mm
4484750	59	11,9	18	11	8 mm
4484751	83	11,9	18	36	8 mm
4484752	109	11,9	18	30	8 mm
4484753	109	11,9	18	40	8 mm
4484754	239	11,9	18	137	8 mm
4484755	249	11,9	18	147	8 mm
4484756	154	17,9	26	38	8 mm
4484757	244	17,9	26	128	8 mm
4484758	59	11,9	18	11	3/8"
4484759	109	11,9	18	30	3/8"

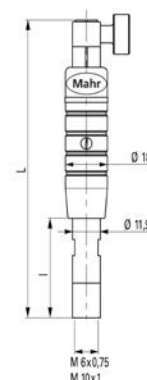

ACCESSORIES

Order no.	Description	Type
4334000	Millimess 1 µm, ± 50 µm	1003
4334102	Millimess 0,5 µm, ± 25 µm	1002
4337620	Digital indicator, 0,0005 mm, 12,5 mm	1086 R
4337624	Digital indicator, 0,0005 mm, 12,5 mm	1086 Ri
4337697	Digital indicator, 0,0001 mm, 12,5 mm	1086 R-HR



Marameter 844 Dge

Plug Gage Holder for inductive Probe

FEATURES

The plug gage holders for inductive probes consist of a handle with cable protection on top. Further features:

- Fixture (in the handle) for an inductive probe $\varnothing 8$ mm e.g. P2004-M for connection to an amplifier e.g. C1200-M
- Integrated fine adjustment for best probe setting
- Connection thread at the bottom to mount a bore gage 844 D / 844 DR / 844 DS.



Application:

Special plug gage holders for precise measurements with inductive probes.

- Mounting element in the holder for inductive probes with cylindrical shaft $\varnothing 8$ mm
- Cable socket with bend protection
- Fine adjustment attachment for the inductive probe
- Connection thread at the bottom for mounting a plug gage 844 D / 844 DR / 844 DS

TECHNICAL DATA

Order no.	Type	Dimension L	l	Connection thread
		mm	mm	
4484760	844 Dge	146	26	M6x0,75
4484761	844 Dge	156	36	M10x1

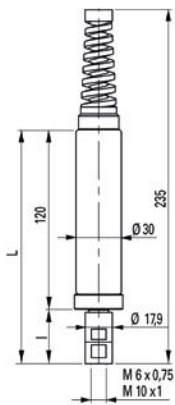

ACCESSORIES

Order no.	Description	Type
5312012	Compact amplifier	C 1200 M
5323010	Inductive probe, ± 2 mm	P2004 M



Marameter 844 Dv

Extension for measuring depth

FEATURES

The 844 Dv depth extension are screwed in between holder 844 Dg and plug gage 844 D / 844 DR / 844 DS (if necessary right angle attachment 844 Dw)

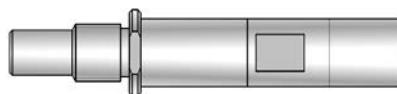

Application:

- For bore measurement at larger depths
- Practical additional function as clamping shank for depth measuring stops 844 Dt

TECHNICAL DATA

Order no.	Type	Dimension L	d1	d2	Connection thread
		mm	mm	mm	
4484770	844 Dv	49	4	7,9	M6x0,75 / M3,5x0,35
4484771	844 Dv	99	4	7,9	M6x0,75 / M3,5x0,35
4484772	844 Dv	149	4	7,9	M6x0,75 / M3,5x0,35
4484773	844 Dv	249	4	7,9	M6x0,75 / M3,5x0,35
4484774	844 Dv	50	6,5	7,9	M6x0,75
4484775	844 Dv	100	6,5	7,9	M6x0,75
4484776	844 Dv	150	6,5	7,9	M6x0,75
4484777	844 Dv	250	6,5	7,9	M6x0,75
4484778	844 Dv	500	6,5	7,9	M6x0,75
4484779	844 Dv	48	11,9	15	M10x1
4484780	844 Dv	98	11,9	15	M10x1
4484781	844 Dv	248	11,9	15	M10x1
4484782	844 Dv	498	11,9	15	M10x1
4484783	844 Dv	750	11,9	15	M10x1
4484784	844 Dv	1000	11,9	15	M10x1
4484785	844 Dv	100	17,9		M10x1
4484786	844 Dv	250	17,9		M10x1
4484787	844 Dv	500	17,9		M10x1
4484788	844 Dv	750	17,9		M10x1
4484789	844 Dv	1000	17,9		M10x1

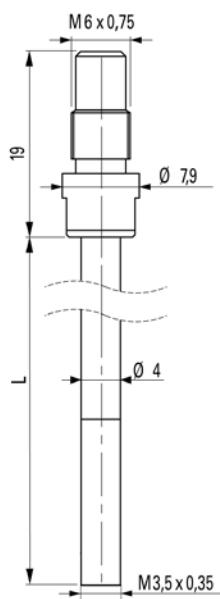

Marameter 844 Dw

Right Angle attachment

FEATURES

The 844 Dw right angle attachment are screwed in between holder 844 Dg and plug gage 844 D / 844 DR / 844 DS (if necessary extensions 844 Dv)

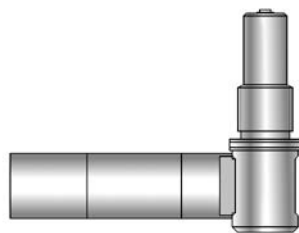

Application:

For space-saving and side entering measurement of bores

Typical measuring problem situations:

- Narrow conditions in turning and grinding machines
- Side outgoing bores or bearing points in housings

TECHNICAL DATA

Order no.	Type	Dimension L	d	Connection thread
		mm	mm	
4473409	844 Kw	29	7,9	M6x0,75
4484790	844 Dw	53	11,9	M10x1
4484791	844 Dw	56	17,9	M10x1

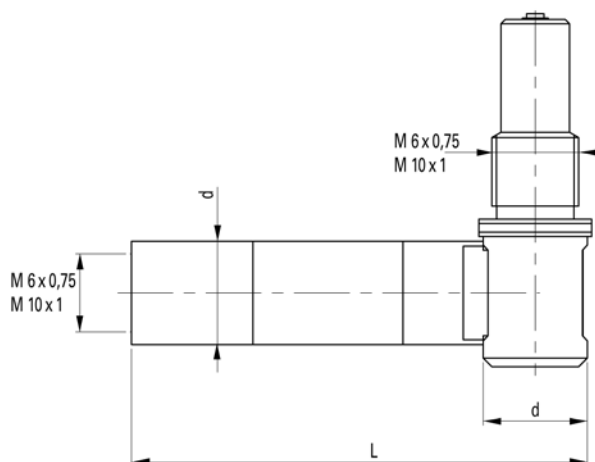

Marameter 844 Dt-3

Depth stop with 3-point touching

FEATURES

For clamping on the shaft of the plug gage holder 844 Dg or measuring depth extension 844 Dv

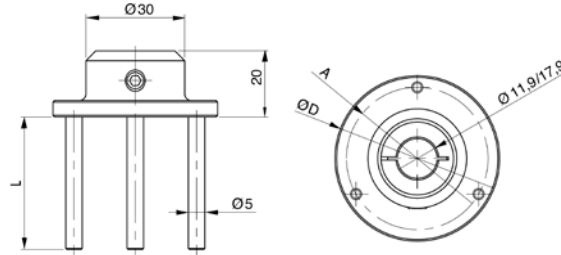

Application:

For measuring at a defined and repeatable measuring depth and to eliminate a tilt error

TECHNICAL DATA

Order no.	Type	Application range mm	Mount Ø	Stop surface diameter A
		mm	mm	mm
4484810	844 Dt-3	for Plug Gages Ø 20 –60 mm	Ø 11,9 mm or Ø 17,9 mm As specified, depending on clamping shank Ø of holder 844 Dg/Dg-XL or measuring depth extension 844 Dv	Diameter Plug Gage + 14 mm
4484811	844 Dt-3	for Plug Gages Ø >60 –80 mm	Ø 11,9 mm or Ø 17,9 mm As specified, depending on clamping shank Ø of holder 844 Dg/Dg-XL or measuring depth extension 844 Dv	Diameter Plug Gage + 14 mm
4484812	844 Dt-3	for Plug Gages Ø >80 –100 mm	Ø 11,9 mm or Ø 17,9 mm As specified, depending on clamping shank Ø of holder 844 Dg/Dg-XL or measuring depth extension 844 Dv	Diameter Plug Gage + 14 mm
4484813	844 Dt-3	for Plug Gages Ø >100 –150 mm	Ø 11,9 mm or Ø 17,9 mm As specified, depending on clamping shank Ø of holder 844 Dg/Dg-XL or measuring depth extension 844 Dv	Diameter Plug Gage + 14 mm

Order no.	L mm	Stop surface diameter A	Mount Ø
		mm	mm
4484810	Individual adaptation/ specification in case to plug gage	Diameter Plug Gage + 14 mm	Ø 11,9 mm or Ø 17,9 mm As specified, depending on clamping shank Ø of holder 844 Dg/Dg-XL or measuring depth extension 844 Dv
4484811	Individual adaptation/ specification in case to plug gage	Diameter Plug Gage + 14 mm	Ø 11,9 mm or Ø 17,9 mm As specified, depending on clamping shank Ø of holder 844 Dg/Dg-XL or measuring depth extension 844 Dv
4484812	Individual adaptation/ specification in case to plug gage	Diameter Plug Gage + 14 mm	Ø 11,9 mm or Ø 17,9 mm As specified, depending on clamping shank Ø of holder 844 Dg/Dg-XL or measuring depth extension 844 Dv
4484813	Individual adaptation/ specification in case to plug gage	Diameter Plug Gage + 14 mm	Ø 11,9 mm or Ø 17,9 mm As specified, depending on clamping shank Ø of holder 844 Dg/Dg-XL or measuring depth extension 844 Dv

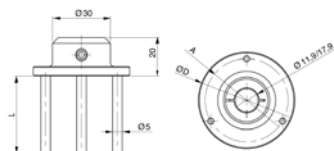

Marameter 844 Dt-B

Depth-Stop Bridge

FEATURES

For clamping on the shaft of the plug gage holder 844 Dg or measuring depth extension 844 Dv

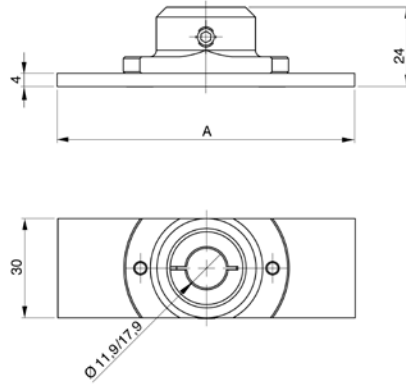

Application:

For measuring at a defined and repeatable measuring depth and to eliminate a tilt error

TECHNICAL DATA

Order no.	Type	Application range	Mount Ø	Stop surface diameter A
		mm	mm	mm
4484821	844 Dt-B	for Plug Gages Ø 16 – 60 mm	Ø 11,9 mm or Ø 17,9 mm As specified, according to clamping shank Ø of holder 844 Dg/Dg-XL or measuring depth extension 844 Dv	Bore plug gage diameter + 10 mm
4484822	844 Dt-B	for Plug Gages Ø >60 – 80 mm	Ø 11,9 mm or Ø 17,9 mm As specified, according to clamping shank Ø of holder 844 Dg/Dg-XL or measuring depth extension 844 Dv	Bore plug gage diameter + 10 mm
4484823	844 Dt-B	for Plug Gages Ø >80 – 100 mm	Ø 11,9 mm or Ø 17,9 mm As specified, according to clamping shank Ø of holder 844 Dg/Dg-XL or measuring depth extension 844 Dv	Bore plug gage diameter + 10 mm
4484824	844 Dt-B	for Plug Gages Ø >100 – 160 mm	Ø 11,9 mm or Ø 17,9 mm As specified, according to clamping shank Ø of holder 844 Dg/Dg-XL or measuring depth extension 844 Dv	Bore plug gage diameter + 10 mm

Marameter 844 Dt-S

Depth-Stop Disc

FEATURES

Full round design. For clamping on the shaft of the plug gage holder 844 Dg or measuring depth extension 844 Dv

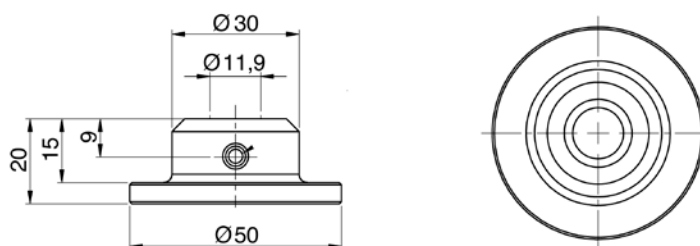

Application:

For measuring at a defined and repeatable measuring depth and to eliminate a tilt error

TECHNICAL DATA

Order no.	Type	Application range mm	Mount \varnothing	Stop surface diameter A
		mm	mm	mm
4484820	844 Dt-S	for Plug Gages \varnothing 16 –40 mm	\varnothing 11,9 mm	Full round design, diameter 50 mm

Marameter 844 Dt-R

Depth-Stop Ring

FEATURES

For clamping direct on guide cylinder of plug gage 844 D / 844 DR / 844 DS

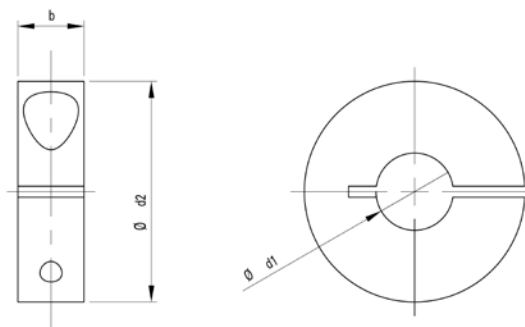

Application:

For measuring at a defined and repeatable measuring depth and to eliminate a tilt error

TECHNICAL DATA

Order no.	Type	Application range mm
		mm
4484800	844 Dt-R	for Plug Gages \varnothing 3 –40 mm
4484801	844 Dt-R	for Plug Gages \varnothing >40 –60 mm
4484802	844 Dt-R	for Plug Gages \varnothing >60 –90 mm
4484803	844 Dt-R	for Plug Gages \varnothing >90 –105 mm



Mahr GmbH

Carl-Mahr-Straße 1
37073 Göttingen
Germany
Tel.: +49 551 7073-800
Fax: +49 551 7073-888

Reutlinger Str. 48
73728 Esslingen
Germany
Tel.: +49 711 9312-600
Fax: +49 711 9312-725

info@mahr.com
www.mahr.com

© Mahr GmbH

We reserve the right to make changes to our products, especially due to technical improvements and further developments. All illustrations and technical data are therefore subject to change.

3765729 | 09.2021