



USER MANUAL

Adash A4400 VA4 Pro



Content:

Before you begin read this manual	7
Before Switching On.....	8
General warnings	8
PC USB connection warning	8
Battery charging	9
General information.....	10
The switch-on	10
The switch off	10
Auto switch off	10
The emergency switch off	10
Disc free capacity warning	10
Connection to the computer	11
The charging	11
The DSP board - monitoring and reset.....	11
Virtual Analyzers Data Processing	11
Run the instrument on your computer	11
How to work with Menu	12
Item selection	12
User defined values.....	12
Multi-selection of items	14
Searching of item	14
Input channels	15
IN1 socket	15
IN2 socket	15
IN3 socket	16
IN4 socket	16
TRIG socket	16
Standard cable wiring.....	17
A4409 - BNC Box	18
Sensors properties	19
AC sensors.....	19
ISO 10816 Machine Groups.....	20
Bearing Settings.....	20
DC sensors.....	21
Tacho	21
Settling prolongation.....	22
Sensor Properties of recorded signal	22
Global properties	23
Power Off	23
Brightness	23
Screenshot	23
The About	23
Help.....	23
Trigger Settings	24
Global Settings	25
Appearance	27
Runup.....	27
Spectrum Settings	28
Date/ Time.....	28
User Notes Settings	28
Profiles	29

Signal Source	29
The Main screen.....	31
Update of the unit firmware	31
Update of bearing database	31
Battery capacity	32
Instrument buttons	33
Control and Menu buttons	33
The Shift button	33
Speed detection	34
The Analyzer mode	35
The Meas	35
The Graph	35
The Set.....	35
The Project.....	35
Export of the Project to the VA4_DISC (flash disc)	35
First Analyzer screen.....	36
New Project - Set creation.....	36
New Project - L1/Set creation.....	37
New Project - L2/L1/Set creation.....	37
New Meas creation.....	38
New Basic	38
New Advanced	40
Next Meas functions	41
CSV file description	42
Next functions available for list of projects	42
Functions for Set	42
Enter speed	43
Cancel speed	43
Measurement Definition in the Set	43
Input Buffering	44
Band fmin[Hz] - HP filtering	45
The Analyzer buttons description	45
The Arrow Mode button	45
The Start, OK button	46
The Stop, Cancel, Back and Close button	46
Graph Max/Min	46
Graph Properties	46
Overall measurement	52
ISO 10816 overall measurement.....	54
G-demod overall measurement.....	54
Time signal measurement	54
G-demod time signal measurement	55
Orbit measurement.....	55
Filtered orbit measurement	56
S-max measurement	57
Spectrum measurement	58
G-demod spectrum measurement.....	58
Cepstrum measurement.....	59
Speed measurement	59
ACMT measurement	60
Orders measurement	60
1x amp+phase measurement.....	61
Phase Shift.....	61
Frf - frequency response function.....	62
DC measurement	64

Center line measurement	64
Octave Spectrum.....	65
Fasit.....	65
Ultrasound.....	65
Record.....	66
The Balancer	67
Introduction.....	67
The Project.....	67
The Project Screen.....	67
The first screen.....	68
New project	70
Balancer Settings	70
Basic Settings	70
Units Settings	71
Rotor Settings	71
Single plane balancing	72
RUN 1 screen	72
RUN 2 - the TRIAL MASS screen	73
RUN 2 - the RESULT screen	75
The RUN 3 screen	76
Trim Screens	76
Dual plane balancing.....	76
RUN 1 screen	76
RUN 2 with trial mass in plane 1	77
RUN 2 with trial mass in plane 2	78
RUN 2 - Result screen	79
The RUN 3 screen	80
Trim Screens	81
Balancing Errors.....	81
The effect of trial weight is low	81
The RunUp.....	82
Measurement Control.....	82
The Set and other items	82
Run up measurement.....	82
Menu Trend.....	83
The Route	85
Loading of the route to the instrument.....	85
Creation of the route tree	85
Route measurement.....	85
Reference values	87
Manual entry.....	88
Notes	88
New note	89
Note edit	90
Export to VA4_DISC.....	90
Download of the route to the computer	90
Speed in the route	91
Speed entered in the VA4	91
Speed entered in DDS	91
Measured Speed	91
The Recorder.....	92
New Record.....	92
Editing of Record.....	93
Project button	93
Export to wav Settings	94

Sensors button	94
Record button	94
START button	94
Properties button	94
Cursor and Length arrow buttons	94
Arrow mode	95
Zoom X button	95
Zoom Y button	95
Using of record for analyzing.....	95
The FASIT	97
Set-up.....	97
Sensor Settings	97
Units	97
Measurement	97
FASIT screen	98
Vibration Limits.....	98
Machine limits.....	100
Bearing Limits.....	101
Unbalance, Misalignment and Looseness.....	101
The Stethoscope.....	102
The delay of audio output.....	102
Playback Settings.....	102
The Lubri - the greasing control.....	103
Two Possible Ways How to Measure	103
The procedure	104
Octave Analysis	106
Bump Test	108
Settings	108
Amplitude trigger setting.....	108
Response spectrum	109
Analyse.....	110
ADS.....	111
ADS project	111
Import of project from computer to VA4	111
Rewriting of geometry	111
Project menu	111
Copy	112
Rename	112
Delete	112
Clear Data	112
Export Data	112
Export Project	112
ADS Settings	112
Measurement definition	113
Reference direction	113
Frequency for Animation	113
Views.....	113
Machine View	113
Measurement View	114
Machine+Measurement View	114
Automatic change of view	116
Buttons in Machine View	116
Fit	116
Arrow Mode	116

<i>ADASH Ltd.</i>	<i>Adash 4400 – VA4Pro</i>
Point	116
Direction	116
Zoom/Move/Rotation	116
Blink on/Blink off	116
Hide on/Hide off	116
Start/Stop Animation	116
Enter Direction	116
Start	116
Buttons in Measurement View.....	116
180° on/180° off	116
Save	117
<i>Ultrasound.....</i>	<i>118</i>
Introduction.....	118
Sensor setting	118
Settings	118
Measurement	119
Listening.....	119
<i>A4410 Virtual Unit.....</i>	<i>120</i>
Installation	120
A4404 – Signal Analyzer Box drivers installation	120
License file	121
Update.....	121
Operation.....	121
VA4_DISC.....	121
VA4_DISC Folders Structure	121
A4410 Virtual unit with the DDS connection.....	122
A4410 Virtual unit and A4400 VA4Pro connection.....	122
Copying projects to the VA4Pro instrument	122
Projects and records copy from the VA4Pro instrument	122
The Virtual Unit vs. the real instrument differences.....	123
<i>Appendix A: Technical Specification.....</i>	<i>124</i>
Inputs.....	124
Dynamic Channels (AC)	124
Tacho Channel	124
Static Channels (DC or 4-20mA)	124
Measurement Functions.....	124
Recording:.....	125
Balancing:.....	125
General:.....	125
<i>Appendix B: ACMT bearing and gearbox measurement.....</i>	<i>126</i>
Applications.....	126
Description	126
ACMT is the solution	126
Example	126
The ACMT method can do even more	127

Before you begin read this manual

The VA4 unit is continuously developed and new functions and features are added often. Such additions also require changes in manual and that changes can be very time expensive. That is why we do not change all pictures in the manual so that are related to the latest version. Some pictures (which are usually only backgrounds) remain in the manual although they were changed already. Certainly it is acceptable only on places, where such background has no consequence.

Before Switching On

Ignoring any recommendations mentioned below may cause failure of the device.
Operating with a power higher than 24 V can cause an accident.

General warnings

Never connect higher than 30 V to the Analyzer !

Only suitable ICP powered sensors can be connected to the AC signal inputs.

If the measurement without ICP power is required, ICP power must be switched off. You can damage the external signal source, which is not protected against ICP powering.

AC channels - voltage higher than ± 18 V (peak) can damage the instrument.

DC channels - voltage higher than ± 30 V (peak) can damage the instrument.

Always use only original cables designed for connection with sensor.

Long push and hold of POWER button evokes incorrect instrument switching off. Data could be lost.

If you are unsure, contact your distributor or the manufacturer.

PC USB connection warning

Switch off the A4400 instrument when you connect/disconnect it to/from computer by USB cable.

Battery charging

Charge the battery only at 0 - 40°C (30 - 100 °F) !

The unit uses Li-ION (LiION) batteries. This type of battery should not be discharged completely. If the battery is discharged below certain Voltage, we call it deep discharging. The deep discharging shortens battery life. The charging of deeply discharged battery takes much longer.

If the unit is not charged for longer period of time, then the deep discharge can occur. It is caused by self-discharging of the battery. Another cause of deep discharge can be a situation when the unit is switched to the SLEEP mode by the Power Off button (instead of switching off the unit).

When the battery is deeply discharged, it takes much longer to charge it again. Sometimes the indicator on the charger does not light when the battery is deeply discharged – it does not mean it is not charging. Please keep the battery charging even if the indicator does not light, the indicator will start light eventually.

To avoid deep discharge of the unit, charge the unit regularly, even when you don't use it. We recommend you to check if it is charged every 3 months.

WHAT TO DO WHEN YOU CANNOT SWITCH ON THE UNIT/ WHEN THE UNIT CANNOT BE CHARGED NORMALLY:

- **Discharged battery** – battery needs to be charged (charging for approximately 3 hours), the unit can be switched on normally with the charger connected
- **Deeply discharged battery**, when the unit wasn't charged for longer period of time – the unit needs to be charged completely until the indicator on the charger starts light green. It can take more than 12 hours. The indicator on the charger does not light from the beginning of charging process. Sometimes it is not possible to switch on the unit even with the charger connected.
- **Damaged charger** – when the charger is connected, the indicator should start to light (green or orange color), only with deep discharge the indicator does not light immediately.
- **Sudden decrease of battery life** – the unit needs to be charged and discharged completely few times (usually 2-5 times). The battery lifetime should increase this way.

General information

The switch-on

Use the **POWER** button for switch-on (older versions had the button in different position as in the picture).



The green LED on the front panel (right at the top) lights after switch-on.



The switch off

The switching off can be done by:

- **Power Off** button on the main screen,
- in the **Global** menu is the **Power Off** item available.



Auto switch off

If no button is pushed in 5 minutes from switching on, the unit will be switched off.

The emergency switch off

This is not correct method to switch off the instrument. Using it can cause data corruption. Use this method only in case of emergency (eg. when the system freezes).

Push and hold the **POWER** button for about 5 seconds. Instrument will switch off.

Disc free capacity warning

If this warning message appears, you need to get free disc space by removing the measurements, routes or records, which are not actual.

90% of disc is full.
Longer measurements not available.

Connection to the computer

The instrument contains the flash memory (**VA4_DISC**), which is accessible from external computer. Use the USB cable, which is the standard accessory of VA4 set. Connect the small plug to the USB socket (see the image above). Connect second plug to the computer.

The charging

The socket for external charger (instrument accessory) is above the POWER button. The **BAT** LED on the upper panel lights orange during charging. When the battery is fully charged, it lights green.

The DSP board - monitoring and reset

The DSP board is the most important part of the instrument. The special chip provides all necessary operations, which are required for achieving of 4 channel synchronous data.

The STAT LED is on the top panel and enables to monitor the DSP board (older versions had the button in different position as in the picture). Several states can appear:

- Green with 0.25sec time interval (4Hz, four times per sec) - the measurement is running.
- Green with 1 sec time interval - STANDBY, the measurement is not running.
- Red - the DSP board does not work properly.

When the red STAT occurs, do the reset of DSP board. Do not switch-off the instrument. Use the slim not sharp thing (e.g. paper clip) and push the button, which is hidden in the **RST** hole.

Next LED is near each input connector:

- green – OK
- no light – no measurement is taken in this input
- red – error (usually ICP error).

Note: During the measurement are functional only LEDs for inputs used for measurement (e.g. red LED ends the lighting during the measurement and starts again after it).

Virtual Analyzers Data Processing

When older Analyzers would take more measurements, they took them step by step. If the user wanted e.g. acceleration overall, velocity overall, velocity time signal and velocity spectrum from one sensor, then the Analyzers took first overall, then second overall with integration, then time signal and finally spectrum. The time which was required for all 4 measurements was the sum of 4 individual times.

The instrument includes high speed chips and it uses the much more advanced concept. For every individual measurement is created one virtual Analyzer in the instrument memory. All virtual Analyzers read data from input DSP board and perform required data acquisition.

What does it mean? It means, that the total required time is not equal the sum of all individual times, but it is equal the time required for the longest measurement.

Run the instrument on your computer

The A4410 Virtual Unit you can download from the producer's website. Easily unzip the zip file and run the bat file. Now you can easy try to work with all functions in your computer. Do not forget define the record as signal source. You can also download the next records from that website. See the A4410 Virtual Unit chapter for more details.

How to work with Menu

For the taking of measurements you have to define many parameters. All those definitions are providing by menu items. The procedure for operation with all menu items is the same. We describe it on example - the sensor properties definition.

Item selection

The sensor properties first menu appears after you push the **Sensors** button.

AC 1
AC 2
AC 3
AC 4
All AC Sensors
All Bearings
All ISO
DC 1
DC 2
DC 3
DC 4
All DC Sensors
Tacho

Use the arrow buttons for one item selection, e.g. **AC2**. Then push **OK** button. The second menu appears.

ICP:	on
Sensitivity[mV/g]:	100
Unit:	g
Position[°]:	undef
ISO Machine Group:	undef
Bearing Type:	undef
Save	

Again use the arrow button for one item selection. Then push the right arrow button to display possible parameters of selected item. E.g. for Sensitivity you see this picture:

ICP:	on	
Sensitivity[mV/g]:	100	1
Unit:	g	10
Position[°]:	undef	100
ISO Machine Group:	undef	user
Bearing Type:	undef	
Save		

User defined values

Again use the arrow button for one sensitivity selection (**1,10,100**). In most of cases you want to enter the **user** sensitivity according to the real sensor sensitivity of your sensor (e.g. 96,8 mV/g). Select the **user** and push **OK**. The next window appears and the buttons get the numerical values entry functions.



Use the buttons and enter required value (e.g.45). If you need to edit the value, push the **Shift** button. The buttons change the functions of buttons.



Now you can move the cursor, to use the **Delete** function. Press the **Shift** again and the buttons functions change back. When the value is correct, push **OK**. The menu with new value appears.

ICP:	on
Sensitivity[mV/g]:	45
Unit:	g
Position[°]:	undef
ISO Machine Group:	undef
Bearing Type:	undef
Save	

Use the arrows and select the **Save** item. Press the **OK** button and the working with sensors menu will close. Also you can use the **Save** button with the same function. When the **Cancel** button is used, then nothing is saved.

As we mentioned the value entry, also the text has to be entered in some menu items. The screen looks similar to the numerical screen. The only difference is the characters selection on buttons. It works like mobile phones keypad, for second character selection you must press the button two times.

Multi-selection of items

Sometimes you could need to work with more than one item together. The usual example is the deleting of more items in one step.

The left bottom button **Multi on** enables to select more items at once. Press the **Multi on** button. When you move in the list by arrows, the items remain selected (red color) or unselected (black color). Press the same button (now the **Multi off**) again for ending of multi-selection.

Meas_Point_A	S
Orda	S
Plant_W	L2
Point_DC	S
Pump_P	L1

Example of multi-selected items. It needs a short time to play with and to find the right understanding of this feature. The item with the cursor (the full blue field) can be selected or unselected too. The standard yellow color means unselecting and the red color means selecting.

Searching of item

If the list is too long or you know the name, then use the **Find** button. Enter the name or part of name and confirm.

Input channels

All input sockets are in the top panel. The versions older than 0200 had only 3 sockets in the panel.



The input sockets labeled IN1, IN2, IN3, IN4 are used for AC or DC signals. The input socket labeled TRIG is used for trigger signals, usually tacho. All sockets have several pins. It enables to connect more signals to one socket (see wire diagrams).

The AC inputs enable to measure max voltage peak +/-12V. The DC channels enable to measure max +/-24V.

IN1 socket

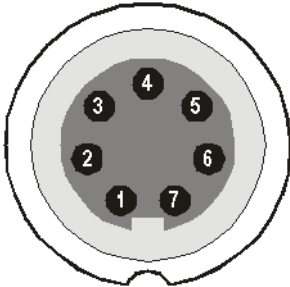

- 1 – CH1 AC INPUT
- 2 – GROUND
- 3 – +20V DC OUTPUT (max 10mA) for eventual sensor powering
- 4 – SHIELDING
- 5 – NOT USED
- 6 – CH1 DC INPUT
- 7 – NOT USED

IN2 socket

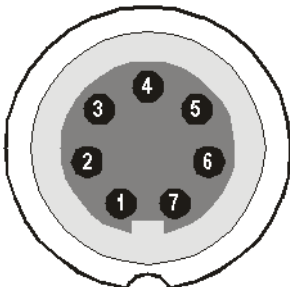

- 1 – CH2 AC INPUT
- 2 – GROUND
- 3 – CH1 AC INPUT
- 4 – SHIELDING
- 5 – CH3 AC INPUT
- 6 – CH2 DC INPUT
- 7 – CH4 AC INPUT

Pay attention to possibility of connecting all four AC channels to **IN2**.

IN3 socket

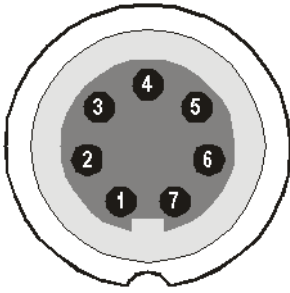

- 1 – CH3 AC INPUT
- 2 – GROUND
- 3 – CH1 DC INPUT
- 4 – SHIELDING
- 5 – CH4 DC INPUT
- 6 – CH3 DC INPUT
- 7 – CH2 DC INPUT

Pay attention to possibility of connecting all four DC channels to **IN3**.

IN4 socket

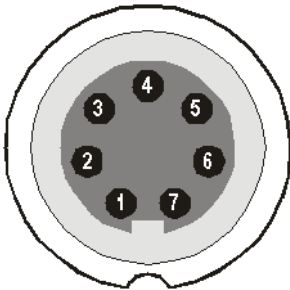

- 1 – CH4 AC INPUT
- 2 – GROUND
- 3 – +20V DC OUTPUT (max 10mA)
- 4 – SHIELDING
- 5 – NOT USED
- 6 – CH4 DC INPUT
- 7 – NOT USED

TRIG socket

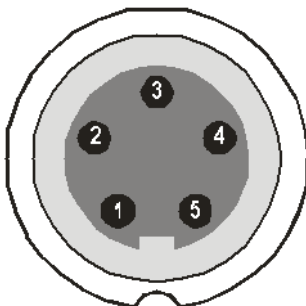

- 1 – GROUND
- 2 – NOT USED
- 3 – NOT USED
- 4 – +5 V OUTPUT/ 50 mA for tacho power supplying
- 5 – TRIG INPUT - for tacho signal

Standard cable wiring

The standard cable, which are the part of the unit, have the sensor signal connected to the pin number 1. The second sensor wire is connected to the ground (pin 2).

When you use this cable:

In IN1 socket, the signal will be measured on CH1.

In IN2 socket, the signal will be measured on CH2.

In IN3 socket, the signal will be measured on CH3.

In IN4 socket, the signal will be measured on CH4 (ver. 2.0 and higher).

If you want to use the 3-direction sensor, then you should use the IN2 socket (pins 3,1,5) + ground (pin 2). You need the special cable for this purpose.

A4409 - BNC Box



This box can simplify the connection of more cables to VA4Pro inputs. The BNC input connectors are used on the top panel for connection of 4 AC channels and 4 DC channels. On the side panel are two Binder connectors, which enable to connect all 4 AC channels to IN2 input and all 4 DC channels to IN3 input. See the wiring diagram of IN2 and IN3 in previous chapter. You see, that all 4 AC channels can be connected to one input IN2. In the same way all 4 DC channels can be connected to one input IN3.

Sensors properties

When you connect the sensors to the instrument, you have to tell what kind of sensors you use. The **Sensors** button is on most screens in the bottom. You can define the bearing and ISO 10816 group for every AC channel individually.



Push the **Sensors** button. In the next menu select channel sensor you want define.

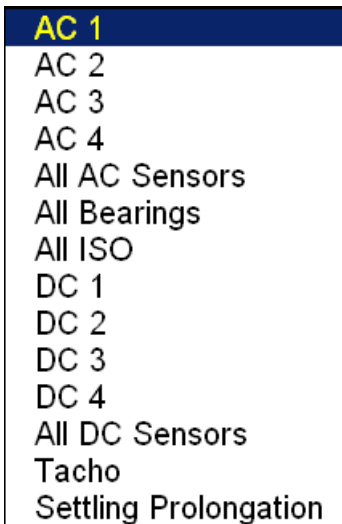

- AC1 – AC4** setting of each AC channel properties (sensor, ISO 10816 group, bearing)
- All AC Sensors** setting of all AC channels together
- All Bearings** setting of one bearing to all AC channels
- All ISO** setting of one ISO 10816 group to all AC channels
- DC1 – DC4** setting of each DC channel properties
- All DC sensors** setting of all DC channels
- Tacho** setting of tacho channel properties
- Settling Prolongation** if you need longer time for sensor settling, use this item

AC sensors

AC (alternate current) sensors are used for signals, e.g. vibrations.

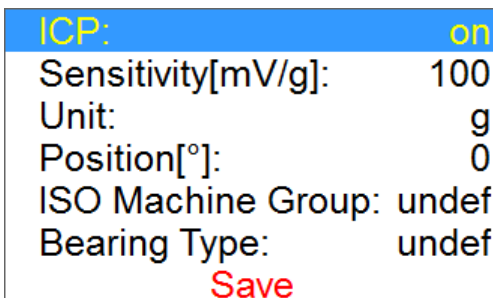

- ICP** **on, off** (selection of required setting accordingly the sensor type)
- Sensitivity[mV/unit]** usually **1,10,100, user**
- Unit** unit selected from the list or user unit
- Position** the angle of sensor (see picture bellow). Usually used for proximity sensors.

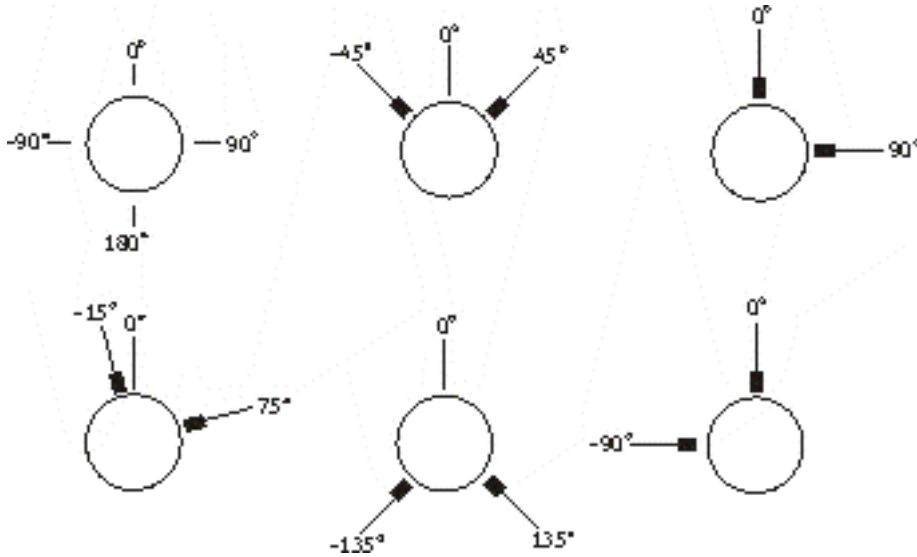

DC gap channel In case of displacement sensor (eddy current) also DC channel could be entered, which is used for gap measurement (eddy current sensor should be concurrently connected to AC and DC input).

ISO Machine Group see next chapter ISO 10816 Machine Groups

Bearing Type see Bearing Settings chapter

ISO 10816 Machine Groups

You can set the appropriate machine group according the ISO 10816 for each channel separately or for all channels together.

ISO Machine Group:	1
ISO Machine Foundation:	rigid
Save	

ISO 10816 Classification of machinery. These parameters are used for limit values according to machine type, nominal power or shaft height.

Bearing Settings

The fault bearing frequencies can be displayed in spectra. The bearing type definition is required for that.

Bearing Type: undef
Save

Select **Bearing Type** item and press **OK** button or right arrow button. From next list select required item and press **OK** button. Also recently used bearings are displayed.

Bearing Type: 6205	database
Rotating Race: inner	user
Save	undef
	6205
	22228(18)-SKF
	3202

Bearing type
 database selection from database

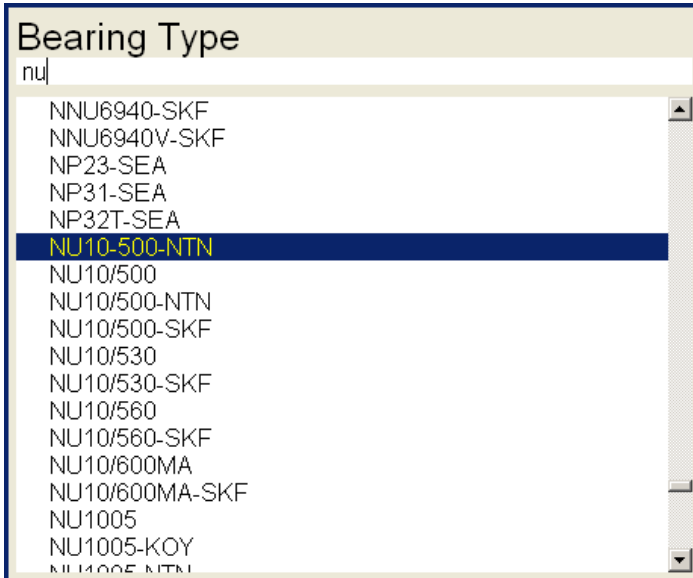

Enter the name (or part of the name) and use the up/down arrows (use **Shift** button to change buttons function) bearing selection. Confirm by **OK**.

user	
Bearing Type:	user
Rotating Race:	inner
Number of Balls:	0
Ball Diameter[in]:	0
Bearing Pitch Diameter[in]:	0
Contact Angle[°]:	+0.0
Save	

If the required bearing is not contained in the database, then you can define the parameters manually.

none none bearing defined, the fault frequencies will not be displayed

Rotating Race for correct calculation of fault frequencies the selection of rotating race is required.

DC sensors

DC sensors are used for discrete current signals, e.g. temperature, pressure,

After selection of **DC1 - DC4** or **All DC Channels** item the sensor properties menu appears.

Sensitivity[mV/μm]:	-8
Offset[mV]:	-8000
Unit:	μm
Position[°]:	45
Save	

Sensitivity[mV/unit] sensitivity value

Offset[mV] offset value

Unit unit selected from the list or user unit

Position the angle of sensor (see picture above). Usually used for proximity sensors and **GAP** measurement.

The used formula: **output value in Unit = (input value in mV - Offset) / Sensitivity.**

Tacho

The speed is measured from tacho channel. The signal contains one or more pulses per one rotation. The pulses can also trigger the measurement.

The VA4 uses the falling edge of tacho signal for triggering (it means the end of the tacho mark).

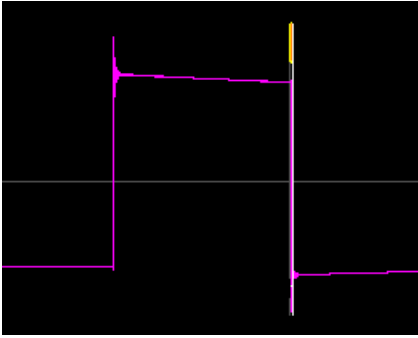

Tacho Trig Level[V]: 1
Pulses per Rotation: 1
Min Speed [Hz]: 0.5
Save

Tacho Trig Level The correct reference value has to be set for speed measurement. E.g. when the standard tacho level is 0.5V and the pulses rich the 1.5V, then the value 1V should be correct. The negative pulses are not allowed, you need to use Adash converter for them.

Pulses per rotation This value has to be set for correct speed evaluation, when more pulses are generated during one rotation. The Trigger Source=tacho is not available for more then one pulse.

Min Speed The lowest speed, which the user is interested to measure with tacho. We suppose that there is one puls per one revolution. In other words, it means how long the instrument will wait for two tacho pulses (the speed is calculated from the time between two pulses). When the pulses are missing, then the NO SPEED error is displayed. When you choose 1Hz, then the waiting interval is 1 second. When you enter 0.1Hz, then you will wait 10 seconds. You should be aware of time prolongation of each measurement.

Settling prolongation

Sometimes you can need longer time for sensor settling. Set the required additional time in seconds.

Sensor Properties of recorded signal

When you use the record (recorded signal from memory) for analysis, then the sensor properties are defined in the record, because you had to define them before the recording. You can change them for next analysis, but this change is not written to the record. The original values are kept in the record.

The new values will be used only for analysing.
Nothing is rewritten in record.

Global properties

The parameters which have effect to all or many functions are understood as Global parameters. The definition is made by **Global** button.

Trigger Settings	
Global Settings	
Appearance	
Runup	
Spec Settings	
Date/Time	
Speed Check	
User Notes Settings	
Profiles	
About	
Help	
Screenshot	
Brightness	
Power Off	
Signal Source = Live	

Power Off

Additional way for switching off.

Brightness

Screen brightness settings (for instruments made after November 2013).

Screenshot

The screenshot will be saved in bmp format to the **Screenshots** folder on VA4_DISC. It contains sub-folders for each mode.

The About ...

Version:	0222
Licence:	000000
Built:	2013/09/30 07:59:43
Installed:	2013/09/30 07:59:49
Disc Capacity:	138.0GB
Used Space:	10.4GB (7.5%)
Free Space:	127.6GB (92.5%)
VA4_DISC Free Space:	96.6%

Help

Displays html version of manual

Trigger Settings

Trigger Mode:	retrig
Runup Mode:	asap
Speed Change[Hz]:	1.00
Time Change[s]:	1
Trigger Source:	tacho
Pretrig[%]:	0
Ampl Trig Channel:	1
Ampl Trig Level[μ m]:	-20
External Trig Edge:	rising
External Trig Level[V]:	1
Save	

Trigger Mode This setting is used in Analyser and Octave Analysis modes.

single Only one measurement is taken and displayed

retrig When you use the analogue oscilloscope, you see always the actual new signal on the screen. This means the similar thing. The measurement is repeated until you push the **Stop** button. Select the **single** option when you want only one measurement.

RunUp Mode This setting is used in RunUp mode. It has to be defined, how often the data will be taken in the runup mode.

asap The next measurement is taken immediately after previous measurement without any delay.

manual The user starts next measurement manually. For averaging is only one pushing of **START** needed.

speed The next measurement is taken when the speed is significantly different from the previous measurement speed. The user defines in **Speed change(Hz)** item, what it is significant change.

time All measurement are taken with the same time interval between them. The time interval length is define in **Time Change(s)**.

time or speed This option is the combination of speed and time. The next measurement is taken when one of them is changed more then the value **Speed change(Hz)** or **Time Change(s)**.

Speed change(Hz) **1, 10, user** see **RunUp** Mode section (the previous section). The RunUp Mode must be **speed** for value entry.

Time change(s) see **RunUp** Mode section. The RunUp Mode must be **time** for value entry.

Every measurement must be triggered (it means started). When you press the **Start** button for taking the measurement, you run only the preparation. When everything is ready to take the data, then the **Trigger Source** item is applied.

In RunUp mode is the frequency of measurements controlled by **RunUp Mode** at first. Then is applied the **Trigger Source**:

freerun The taking of measured data begin immediately after preparation without waiting for anything.

external The taking of measured data begins, when the external signal (voltage level higher then defined in External Trig Level) appears on the trigger input. Such signal may be generated e.g. when the machine starts to work. This type of signal is usually created in the control system.

manual The taking of measured data begin after pressing the **Start** button. Remember that you should push the **Start** button twice. First pushing is for preparation, second for triggering.

manual sequential Similar to manual, but every measurement for averaging must be start separately. E.g. when AVG=10, then the **START** button must be used 10 times.

amplitude The taking of measured data begin when the signal level exceed the **Ampl Trig Level**, which is set by user also in this menu. Both - positive (rising edge) and negative (falling edge) levels are accepted. The signal amplitude is taken directly from sensor input, no additional filtering is applied.

Examples:

the level is set to 100mV - triggered when the raising signal goes from e.g.99mV to 101mV
 the level is set to -100mV - triggered when the falling signal goes from e.g.-99mV to -101mV

tacho The **tacho** is special case of **external** trigger. When we talk the tacho, we mean the signal (usually like TTL) which contains one pulse during one rotation of the shaft. It can be also understood like series of single external pulses. The taking of measured data begins, when the external signal (voltage level higher then defined **Tacho Trig Level** in tacho sensor) appears on the trigger input (the same like **external** item).

Pretrig (%) value in (100,-100) or user Usually the taking of measurement (e.g. time signal) begins exactly from the trigger moment. But in some applications you are interested also to know the signal before trigger. The required time should be define in seconds, but in signal Analyzers is usually defined as percent part of the total signal length. When 1 second time signal is measured and pretrigger=25, then 0,25s will be taken before trigger and 0,75s after trigger. Also the negative pretrigger could be used. It means that the time signal will be taken later then trigger pulse.

Ampl Trig Channel (1,2,3,4) The number of channel, which will be used for **amplitude** triggering.

Ampl Trig Level (unit) value See the description of **amplitude** mode (Trigger Source section). The unit is the unit of sensor on selected channel (**Ampl Trig Channel**).

External Trig Edge rising, falling edge for triggering

External Trig Level[V] See the description in **Trigger Source/ external**

Global Settings

Display Route Values:	on
Route Autosave:	on
Route START Button:	start
Check Route Sensors:	yes
Display Small Values:	off
Stop if ICP Error:	off
Units:	metric
Frequency Unit:	Hz
Speed Unit:	Hz
Power/Line Frequency[Hz]:	undef
Phase Range:	-180°;180°
Displayed Spectra in Cascade:	32
Date Format:	dd.mm.yyyy
Language:	ENG
Align Graphs:	off
Graph Grid:	on
Cursor Type:	linear
Record Analysis Speed:	fast
Record Analysis Start:	continue
Save	

The underlined values are the default values (factory settings).

Display Route Values on,off When you want to go faster during the route and you do not want to look at measurement results after each point, then set it **off**.

Route Autosave on,off when set to **on**, the data are saved after taking measurement at each point by itself. When set to **off**, then the user after results confirmation has to save it manually (by **Save** button)

Check Route Sensors yes, no

Each point in the route contains the sensor setting, which is defined in DDS. The instrument contains also the sensors setting (**Sensors** button). Both settings are compared for each point during the route readings. When the sensor setting in point is not equal the sensor setting in instrument, then the **Used sensor** window appears. It is the warning to the user.

Used Sensor
on AC1: 100 mV / g, ICP on

The user should connect the correct sensor to the unit with the parameters displayed in window. Confirm by pressing **Ok**. The setting in **Sensors** will be rewritten by point setting in route. You can made changes in setting now using the **Sensors** button.

The sensor can have defined the name in DDS (e.g.ACC100). It should help the user in field to use correct sensor. These names are checked in instrument. When the names are not the same, then the **Used Sensor** window appears. No checking of other parameters is done.

Used Sensor
ACC100 on AC1: 100 mV / g, ICP on

Route START Button **start, start next** "start next" enables immediate start of measuring on next point. The next machine will be displayed after the last point in the machine.

Display Small Values **on, off** When you are interested to see values under the 0,001, then set it to **on** and the values will be displayed in exponential form (e.g. 5,26E-6). Otherwise the 0 (zero) will be displayed.

ICP Initialisation Delay[s] **default, user** the time delay after the ICP is switched on

Stop if ICP Error **on** the measurement is stopped, when ICP error occurs
off the measurement continues, ICP error is only information

Units **metric, imperial, both** (all units appears in the menu)

Frequency unit **Hz, RPM, CPS, CPM**

Speed unit **Hz, RPM, CPS, CPM**

Power/Line Frequency it is used for Elect value in Synch table, which is displayed for spectra

Phase range **(-180, 180) , (0, 360)** the range of phase values

Displayed Spectra in Cascade **32, 128, 256, 512, 1024** the number of displayed spectra in cascade graph. It is not the number of measured spectra !

Date Format **yyyy/mm/dd**
dd.mm.yy
mm/dd/yyyy the a.m./p.m. is used

Language **ENG, CZE,** select your language

Align Graphs **on, off** if more graphs of the same type are displayed, then the Zoom and Cursor function of all graphs can be aligned.

Graph Grid **on,off**

Cursor Type **linear, maxs** this item must be deeply explained. The graph width (e.g.spectrum frequency axe) is displayed on the approx. 600 screen pixels. But the spectrum could have 25600 lines and then 42 lines is displayed in one pixel line (42=25600/600). This number of lines in one graph pixel is different for other total line number and used zoom. In the older VA4 version we used the cursor movement procedure by lines. It means that the cursor moves inside one pixel without any real move on the screen. The users complained about it. In the version 2 we have used another procedure. The cursor moves by pixels, not by lines. In each pixel is hidden more lines and the cursor must display one specific line. What line should we use? When the Cursor type is set to linear, then the step of cursor movement is the number of lines in one pixel. When the maxs is set, then the cursor is always move to the maximum line, which is contained in one pixel.

Record analysis speed **fast, real time** the record could be analyzed in two ways. Let's suppose the record length is 300 sec, it could be e.g. run up record. You want to measure the 1x amp+phase (ampl+phase+speed) during the record. If you want to watch the continuous results, then select the **real time** mode and the processing of record will take 300 sec (the analyzing time is the same time as the recording time

was). If you want to save results to the memory and not to watch them on the screen, then select **fast** mode. The analyzing time will be much faster than 300 sec.

Record Analysis Start **continue, begin, again, ask** these options are used when the record is selected for analysis.

It would be better to use example for explanation. E.g. we use record which length is 60 sec. We define time signal measurement which length is 8 sec. It means when we push Start button, the reading takes 8 sec and position of cursor moves of 8 sec in record.

continue the next reading will start on the end of last reading

begin the next reading will start on the beginning of record

again the next reading will start on the beginning of last reading

ask the user select any option before the reading

IMPORTANT : when you moved the cursor manually, the the next reading will always start from that position.

Appearance



Background Color **black, white** setting of background and other colors. You can create your own colors profile. Use the **create** item below the black and white. The **col.cpy** will be created on VA4_DISC. You can change the RGB value of all colors and then save it with new name. When the instrument is switched on, then all cpy profiles are moved to the instrument and then used. You will find your new name in the list of Background Colors. Use the **Delete** button for removing of user defined colors.

Button Text Color **black, white**

Runup

Contains runup global parameters.

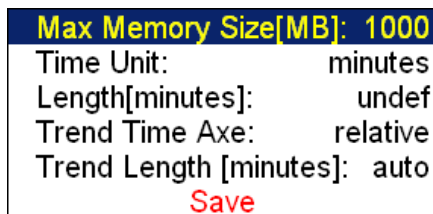

Max Memory Size[MB] **value** It enables partial savings of runup measurement. If the size of measured data exceeds the value, then data are saved and new runup is opened.

Time Unit **days, hours, minutes** The unit of Length parameter (see next line).

Length **undef, value** If defined, then measured data are saved to individual files, where each file contains defined length.

Trend Time Axe

relative the time axe begins from zero

Trend/History - 17.04.2010 02:24:10 22m55.000s (1376/2579)

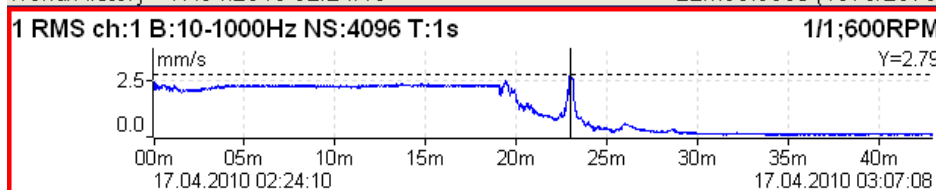

real time the time of measurement is displayed on time axe

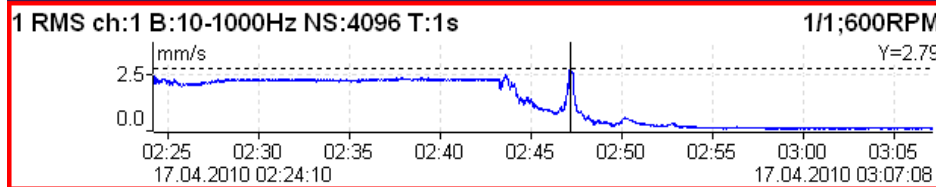

Trend Length auto, value the length of the trend graph (the range of X axe). It is used for RunUp measurement and for the Graph Properties / View Trend. When the auto is used, then all data in the trend are displayed.

Spectrum Settings

These settings are the default settings, which are used for graphs.

Detect Type:	RMS
Axe X:	lin
Axe Y:	lin
Peaks List:	off
Graph Lines:	continuous
Save	

Detect Type RMS, 0-P, P-P the spectrum values on amplitude axe

Axe X lin, log this parameter you can set in **Graph Properties** functions, which are accessible in every graph.

Axe Y lin, log this parameter you can set in **Graph Properties** functions, which are accessible in every graph.

Peaks list on, off the list of peaks can be displayed in each spectrum graph

Graph Lines continuous, discrete the spectrum can be drawn as line through the tops of line or as discrete vertical line for each frequency

Date/ Time

Year:	2013
Month:	07
Day:	22
Hour:	15
Minute:	11
Second:	26
Save	

Set the actual date and time.

User Notes Settings

You can attach the short text notes to route points. There are three ways how handle with notes.

1. Enter the note manually.
2. Select predefined note from **Factory notes** set.
3. Select predefined note from **User notes**. This set is created and edited by user.

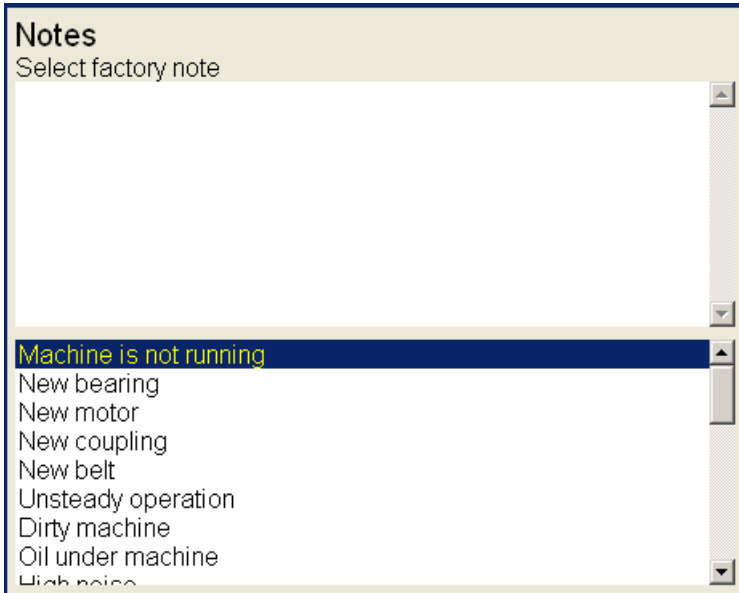

Now we describe how to create the **User notes** list. Press the **Global** button and select **User Notes Settings**. The new window appears. In upper half is the list of existed user notes (now empty). The predefined **Factory notes** are displayed in lower half.

Because usually the user wants to use only the **User notes**, you can copy any factory note to the user notes. Select it by arrows and press **Select** button.

If you want to create your own note, then push **Edit text** button. Enter your note manually. Press the **Save** button and all notes are saved to memory.

Profiles

All instrument parameters can be saved to the **Profile**. It is useful e.g. for saving of sensor sensitivities.

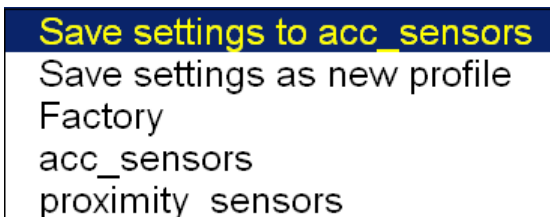

Save settings to name saves the parameters to the Profile, which was opened.

Save settings as new profile save the parameters to the new Profile (after name entry).

Factory opens the factory default Profile

list of saved profiles (acc_sensors, proximity_sensors) selection of existed profile

The **Delete** button removes selected profile.

Signal Source

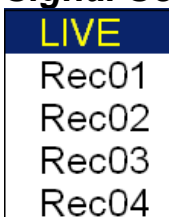

Every measurement can be taken from LIVE channels (AC 1-4 or DC 1-4) or from RECORD (see Recorder chapter for understanding). All records saved in the memory are displayed for selection. Select required item and press **OK** button. The selected signal source is also displayed in the Global window.

If you work with Virtual unit on your computer, use the Default Rec for testing.

The Main screen

After switch-on the Main screen appears. You can select the required mode of the unit.

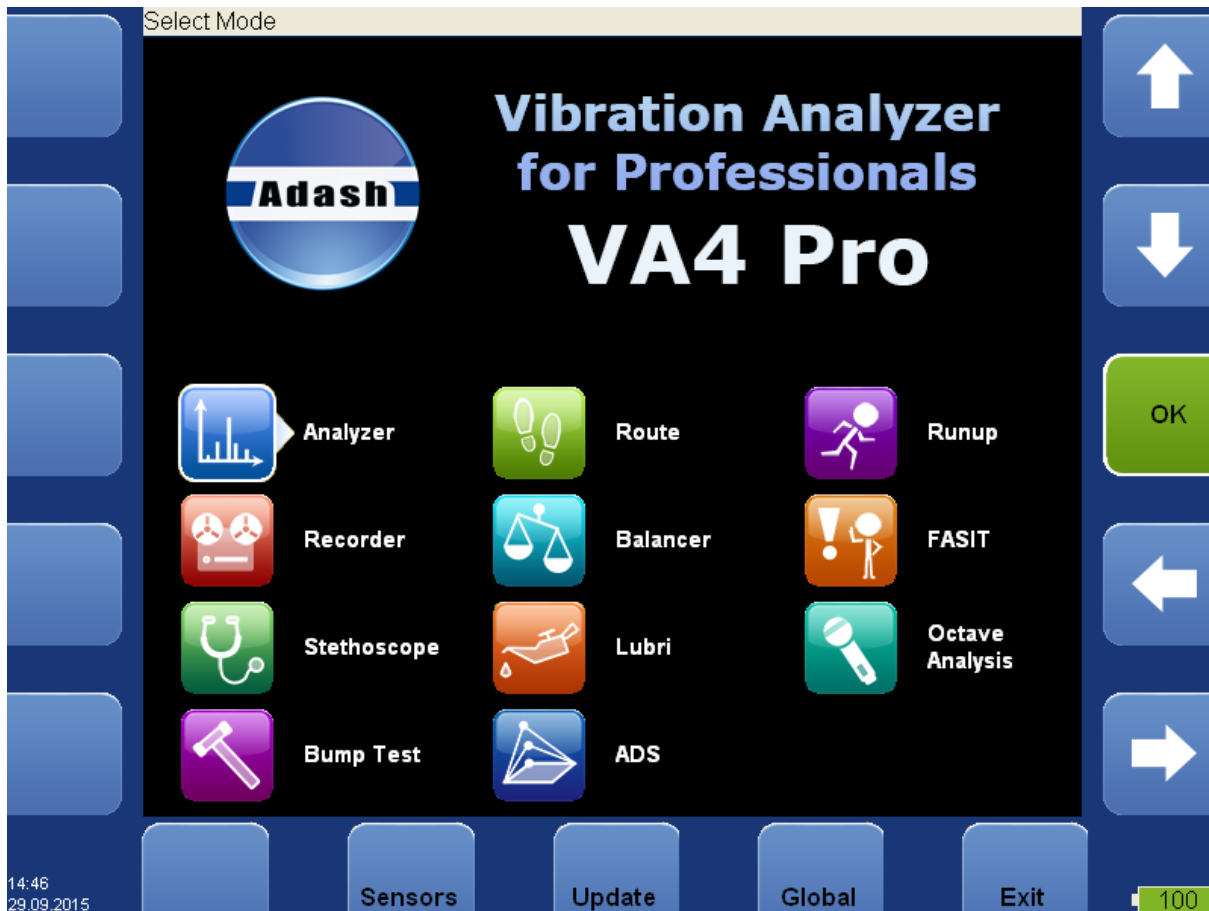

Update of the unit firmware

You can download the updated firmware from producer website www.adash.cz. Follow the procedure:

- Download the file for update (e.g. A4400_ver0202.up2) from website (www.adash.cz) and save it to your computer.
- Connect the instrument to the computer. Remember, it has to be switched off.
- Run the Explorer or other software, which you use for copy of files.
- Copy the update file from the computer to the **VA4_DISC**.
- Use **Safely remove hardware** function and disconnect instrument from the computer.
- Switch-on the instrument to the main screen.
- Push the **Update** button.
- Select the required update file from the list (more version files can be saved in the instrument). Press **OK**.
- The main screen window is closed now. The procedure of update is described in the new command window.
- After the update the main screen appears again.

Update of bearing database

The bearing database you can download from website Adash/ Downloads/ Software Adash. The Bearing Database item is in A4400 - VA4Pro section. The name of the file is **bdx01.va4**.

- Connect the instrument to the computer. Remember, it has to be switched off.
- Run the Explorer or other software, which you use for copy of files.
- Copy the update file from the computer to the **VA4_DISC**.
- Use **Safely remove hardware** function and disconnect instrument from the computer.
- Switch-on the instrument to the main screen. Bearing database is ready to use.

Battery capacity

The information about % of battery lifetime is displayed in the right bottom corner of the display. When the capacity is more than 30%, the green symbol appears. When the capacity is 10-30%, the yellow symbol is used. Under the 10% the red symbol appears. If less than 6%, the lifetime image begins to blink. At that time the running measurements are stopped. The next measurement is not enabled. When the 3% is achieved, the unit will switch off.

Instrument buttons

Fifteen buttons are around the screen allows to control the unit. The function of every button is described on the screen near the button. Such dynamic approach enables to use one button for many functions depending of the actual needs.

Control and Menu buttons

Control buttons with the description are on the left and right screen side. The Menu items with the description are displayed in the bottom of the screen.

The Shift button

The Shift button changes the purposes of buttons. It is used for numerical and text inputs. Also it is used for changing of arrows properties.

Speed detection

You need to know the speed of the measured machine in some cases. We will describe here how the speed detection works. In the following text, this chapter can be mentioned.

Detection is done just before the measurement itself after pressing the Start button. During the detection there is information window displayed in bottom right corner.

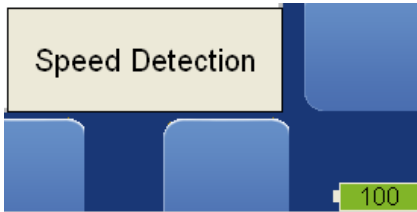

If the tacho probe is detected, no other speed detection will happen. The speed is measured by tacho probe.

The highest peaks are found and displayed in the list. The highest amplitude speed is on the top of list. The spectrum is displayed also. Select the correct value and press **OK**.

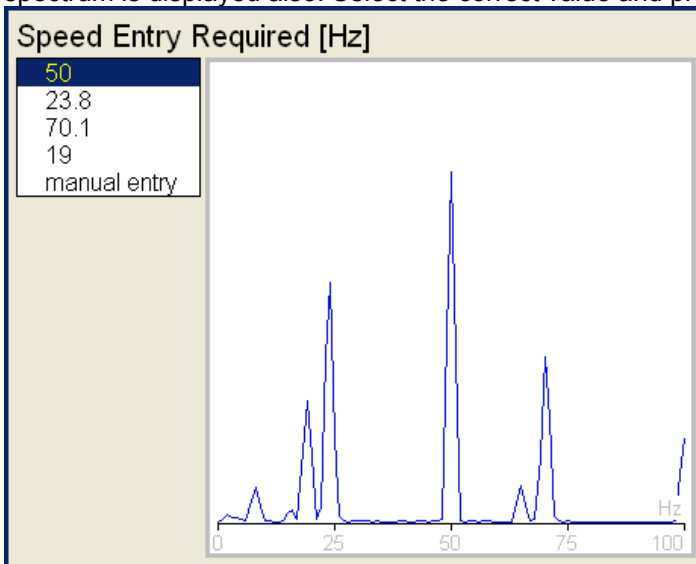

If no value in the list is correct, then select **manual entry** and enter the speed manually. If no value of speed is defined in this window, then the readings will be taken without it.

The speed detection is available only when vibration sensor is used for point reading. In other cases the warning appears. Then the manual entry of speed is required.

Speed could not be detected
Improper sensor

If the measurement for speed detection fails, then error message appears. E.g. ICP error.

Speed could not be detected
ICP error

If the speed value is detected, it is automatically saved to the data header for following measurement in the same way as the speed value measured by tacho probe. If the speed is measured by tacho probe simultaneously, the value from the tacho probe has priority when saving.

The Analyzer mode

The Analyzer mode is the basic mode for signal analysis. If you have not prepared the Route measurement, then you use for analysis the Analyzer mode. All required parameters must be set by hand or you can use the saved measurement parameters from memory.

The Meas

The **Meas** means one measurement as it is usually understood, e.g. overall value or time signal or spectrum or other.

The Graph

The graphical form of that **Meas** values displayed on the screen we will call the **Graph** (overall value, time signal, spectrum, orbit, order analysis. One Graph works with data from one measurement item. You should keep in mind that also one overall value is the Graph.

The Set

The **Set** is the most important term in the Analyzer mode. The **Set** is the set (or group) of one or more measurements **Meas**, which the user wants to take and display together. E.g. you want to take 4 **Meas** together - acceleration overall, velocity overall, velocity time signal and velocity spectrum. You prepare the **Set**, which includes these 4 required measurements **Meas**. The definition of Set is saved in the Analyzer memory. You can save many various Sets, which can contain your often used sets of measurement. Then you select one Set and run it. The taking off all measurements included in the set is made simultaneously. See also **Virtual Analyzers** section for better understanding.

The Project

You can use only various **Sets** for analyzing. But sometimes you can need the more structured items then simple **Set**. Such items we call **Projects**.

Examples:

Meas_Point_A

This is only simple **Set**, which contain several measurements in one point.

Pump_P/ Point_1, Pump_P/Point_2, Pump_P/Point_3

The structured **Project** of 3 **Sets** (3 points) on one machine (Pump_P). This type of Project we call **L1/Set**. It means Level1_Name/ Set_Names.)

Plant_X/ Pump_P/ Points

The structured **Project** with name of Plant (Level2) , names of machines (Level1) and names of Sets. This Project type we call **L2/L1/Set**.

Export of the Project to the VA4_DISC (flash disc)

The computer can read any data from VA4 flash disc only. This flash disc has the name VA4_DISC. The set with measured data has to be exported to the flash before the transfer to the PC. During the set measurement are data saved to the VA4 hard disc only (or SSD). When the set is closed, then the VA4 asks the user "Export to VA4_Disc?" and user selects one option. The export to flash is not done automatically because the writing procedure to flash is slow. That is why the user can determine, when the right moment to export the set is. In the menu item **Set/ Export** you can select the set and export it manually.

First Analyzer screen

The first Analyzer screen contains the list of Projects saved in the memory or the empty list, when no Projects were saved. The time and date of last saving of selected project is displayed in top right corner.

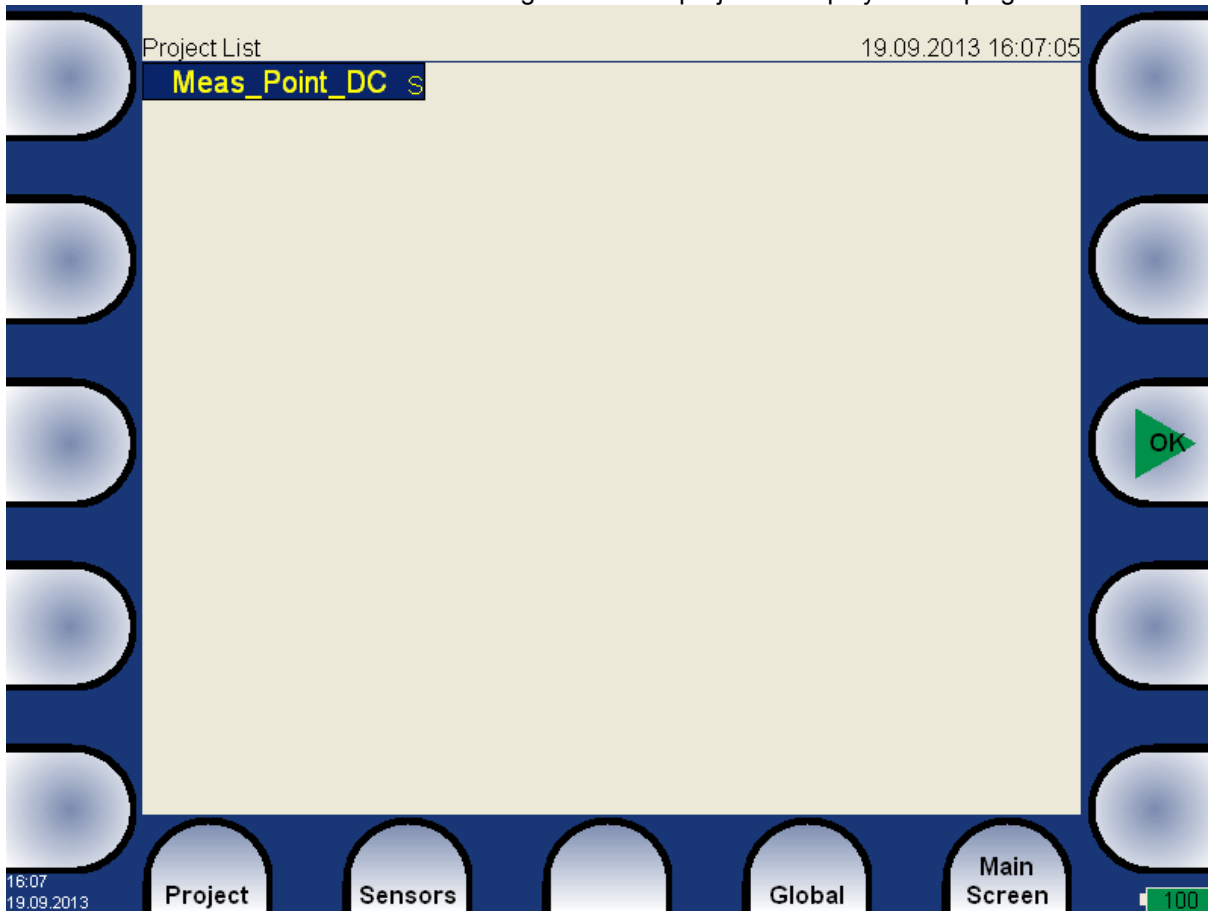

New Project - Set creation

Push the **Project** button. Then menu appears, select **New Set** item.

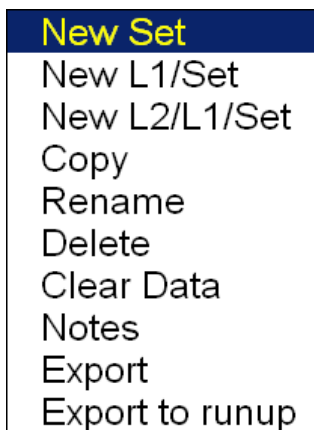

Enter the Set name.

Enter the name of new set. Use the **Shift** button for next buttons displaying. Then press **OK**. Your new item appears in the displayed Project list (alphabetical order).

Project List 19.09.2013 16:08:07

Page Up	Meas_Point_A S	↑
	Meas_Point_DC S	

The **S** letter after the name is the **Set** type indication.

New Project - L1/Set creation

The L1/Set structure usually enables to create the machine item with several points. Push the **Project** button and select **New L1/Set** item.

Enter the L1 name.

Enter the name on Level 1 (e.g. machine name) and press **OK**. The Project list appears (alphabetical order).

Project List 19.09.2013 16:08:54

Page Up	Meas_Point_A S	↑
	Meas_Point_DC S	
	Pump_P L1	

The **L1** letter after the name is the **Level 1** type indication.

L1 item is selected. Push **OK**. The item will be opened and the list of included **Sets** appears (now it is empty).

Pump_P
 Set list

Push the **Set** button and select **New** item.

Pump_P
 Set list
 Enter the Set name.

Enter name and push **OK**. The list of sets appears.

Pump_P
 Set list

Use the **Close Project** button to return back to the project list.

New Project - L2/L1/Set creation

The L2/L1/Set structure usually enables to create the plant with several machines. Every machine can contain several points. Push the **Project** button and select **New L2/L1/Set** item.

Choose required project or select Project / New to create new project.

Shift A/a<-> Enter the L2 name.

Enter the name, push **OK**. The project list appears (alphabetical order).

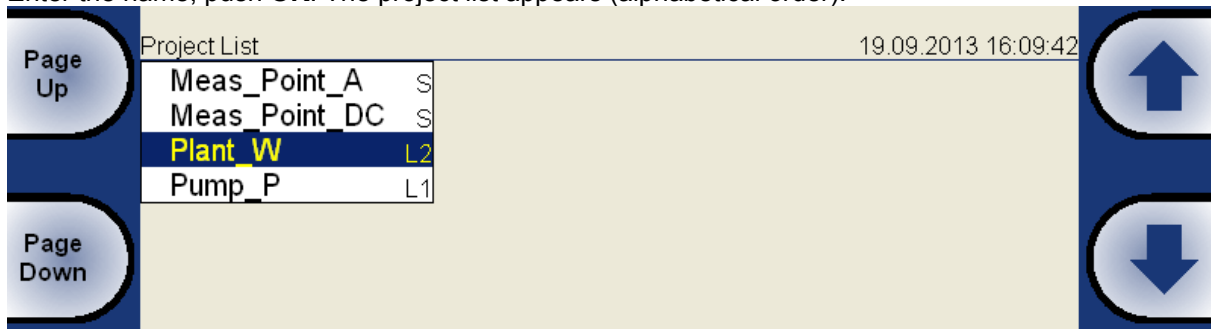

The **L2** letter after the name is the **Level 2** type indication.

Open the Project by **OK**.

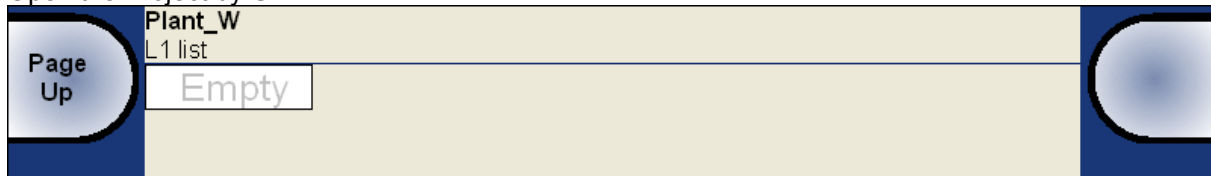

The empty list of L1 items appears. Press **L1** button and select **New**. Enter the name of new Level 1 item.

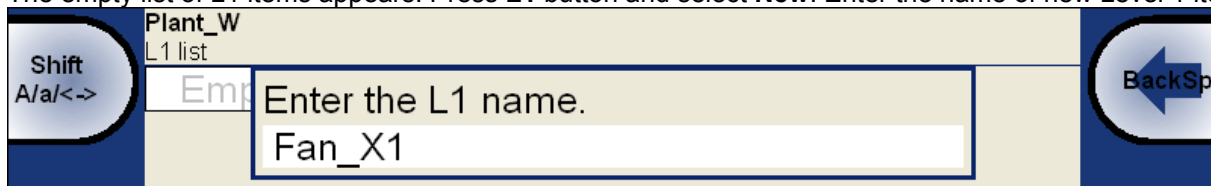

The L1 list appears.

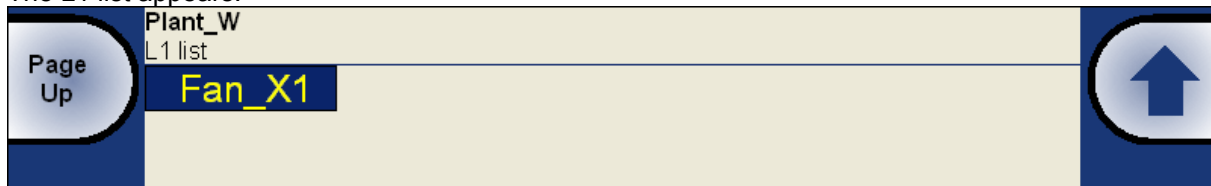

Open the L1 item and create the Set in the same way as it the previous section.

Use the **Back** and **Close Project** buttons to return to the Project list.

New Meas creation

Select the set from Set list of selected Project and press **OK**. Press the **Meas** button and select **New Basic** or **New Advanced**.

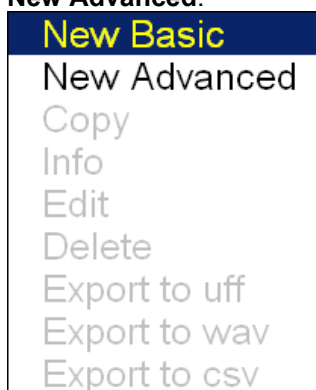

New Basic

You can create the new **Meas** by two ways. When you want define some basic measurement use the **New Basic**. Select required measurement from the list. This way is very fast.

Name	Type	Unit	Frequency Band/Range	Length	Samples	Lines	Average
RPM	speed	RPM					
ISO RMS	wideband RMS	vel	10-1000 Hz	1 sec			
BEARING RMS	wideband RMS	acc	5000-25600 Hz	1 sec			
LBEARING RMS	wideband RMS	acc	500-25600 Hz	1 sec			
OVERALL RMS	wideband RMS	acc	1-25600 Hz	1 sec			
ISO 0-P	wideband 0-P	vel	10-1000 Hz	1 sec			
BEARING 0-P	wideband 0-P	acc	5000-25600 Hz	1 sec			
LBEARING 0-P	wideband 0-P	acc	500-25600 Hz	1 sec			
OVERALL 0-P	wideband 0-P	acc	1-25600 Hz	1 sec			
ISO TIME	time signal	vel	10-1000 Hz	1 sec	4096		
BEARING TIME	time signal	acc	5000-25600 Hz	0,5 sec	32768		
LBEARING TIME	time signal	acc	500-25600 Hz	0,5 sec	32768		
OVERALL TIME	time signal	acc	1-25600 Hz	1 sec	65536		
ISO SPEC	spectrum	vel	1600 Hz	4 sec		1600	4
OVERALL SPEC	spectrum	acc	25600 Hz	1 sec		1600	16

New Advanced

The base menu for definition of measurements appears. The content of the menu is implication of the measurement **Type** selection (first row).

Channel	1, .., 4	The input signal source channel for evaluation.
Unit	name	The required unit for results and graph. This information is used for decision whether and how many integrations should be used.
Detect Type	RMS, Scaled 0-P, Scaled P-P, True 0-P, True P-P, AVG, Crest, Kurtosis	
		The detected value property (P means Peak).
Scaled 0-P		it is equal $1.414 * \text{RMS}$
True 0-P		it is true 0-peak value in the waveform (the highest value captured in time signal).
Scaled P-P		it is equal $2.828 * \text{RMS}$
True P-P		it is true peak-peak value in the waveform (the difference between highest positive and highest negative value in signal)
AVG		it is average value of all samples (total sum of absolute values divided by number of samples)
Crest		it is equal True 0-P/ RMS
Kurtosis		standard statistical formula for Kurtosis
Result Type	H1, H2, H3	Standard frequency response functions, H1- input noise, H2 - output noise, H3 - the average of H1 and H2.
Band fmin (Hz) value		The low cut-off frequency of band pass filter, which is applied to the signal before evaluation. The none value means, that only input DSP filter is applied (approx. 0,6 Hz).
Band fmax(Hz) value		The high cut-off frequency of band pass filter, which is applied to the signal before evaluation. Under this item is also displayed the information about sampling frequency (fs=), which be applied for evaluation.
DEMOD fmin (Hz) value		The low cut-off frequency of band pass filter, which is applied to the signal (removing low frequencies).
DEMOD fmax(Hz) value		The high cut-off frequency of band pass filter, which is applied to the signal (removing high frequencies).
Input channel	1, .., 4	Required only for response functions.
Output channel	1, .., 4	Required only for response functions.
FFT Window	Rectangular, Hanning, Transient, Exponential	The standard offer of FFT windows functions.
Zoom spectrum	no yes	standard spectrum will be made (range fro zero) zoom spectrum will be made (range around the center frequency)
Center freq	value	center frequency for zoom spectrum
Range	value	Frequency range of the graph. Under this item is also displayed the information about sampling frequency (fs=), which be applied for evaluation.
ACMT FS(Hz)	value	The sampling frequency for ACMT evaluation. See the ACMT chapter for understanding.
Trigger control	off on	Time signal will contain defined number of samples Time signal will contain defined number of triggers (e.g.revolutions)
Number of triggers	value	Required number of revolutions (Speed control = on)
Samples	value	Number of samples (Speed control = off). The correspondent signal time length is displayed under this item.

Lines	value	Number of lines. The correspondent signal time length is displayed under this item.
Orders	(1/2,1-5), (1-5), (1/2,1-10), (1-10)	
Avg	value	averaging number
How the averaging is used depends of type of trigger:		
freerun		when the measurement is started, all signals needed for averaging is taken continuously
external		when the external trigger comes, all signals needed for averaging is taken continuously without waiting for next trigger
tacho		every signal for averaging is triggered (constant phase)
amplitude		every signal for averaging is triggered (constant phase)
manual		first signal for averaging is triggered manually, next signals are taken freerun
Averaging	linear , peak hold (for spectrum)	
	linear , maximum, minimum, median (for static values)	
Overlap	% value	Overlapping of signals in averaging.
Resolution		When you use the tacho for 1x amp+phase measurement, the choice of resolution is available. The number of FFT lines must be chosen in the computational procedure. The FFT with fewer lines is faster and displays results more often. When you select higher resolution (e.g.speed/64), then more lines must be used and you will wait for results longer time. If you have some considerable spectrum amplitude near the speed frequency, then you need to select the higher resolution. It eliminates the disturbing influence of the non speed frequency near the speed. Example: the speed is 25Hz. The resolution is speed/4, i.e. 6.25Hz. The speed line bandwidth in FFT will be 6.25Hz. It means, that speed line contains all frequencies in the interval (21.875 , 28.125). If any disturbing frequency is in that interval, then higher resolution must be used.
Frequency	speed, value	the frequency value for phase shift measurement can be entered manually (value) or can be used the speed frequency from tacho sensor.

Next Meas functions

Copy copy of selected measurement to the new one

Info displays measurement properties

Edit enables changes in measurement properties

Delete deletes selected measurement

Export to uff exports data of selected measurement to the uff file format (not for all measurement types), the file is saved to uff folder on VA4_DISC.

If the **Actual** measurement is displayed then only this data will be exported.

If the saved data are displayed (View Trend) then you can export just one displayed data or all data saved in memory. The unit asks you **Export (All/One)?** and then you select the button.

Export to wav exports data of selected measurement to the wav file format (time signal and orbit), the file is saved to wav folder on VA4_DISC.

Time signal is exported as one file with two channels (1ch signal, 2ch trigger).

Orbit is exported as two files (A and B channels).

before exporting you need to enter the required range of signal in wave file. It enables to obtain better resolution in file. If the true peak of signal is e.g.8mm/s, then enter e.g. 10mm/s.

Enter the wav full scale value [mm/s]

10

Export to csv exports data of selected measurement to the csv file format (see next chapter), the file is saved to uff folder on VA4_DISC.

Export to csv (all) Export to csv for all measurements which are in the set (to a directory)

CSV file description

The measurement data are saved in individual lines. Each line contains values depending of type of measurement.

Time	time; amplitude; trigger
g-env Time	time; amplitude; trigger
Orbit	time, amplitude A, amplitude B, amplitude X, amplitude Y, trigger
Spectrum	frequency, amplitude
g-env Spectrum	frequency, amplitude
Cepstrum	frequency, amplitude
ACMT	time, amplitude min, amplitude max, trigger
Orders	order, amplitude, phase
FrF	frequency, amplitude, phase, coherence
Octave spectrum	frequency, amplitude

Next functions available for list of projects

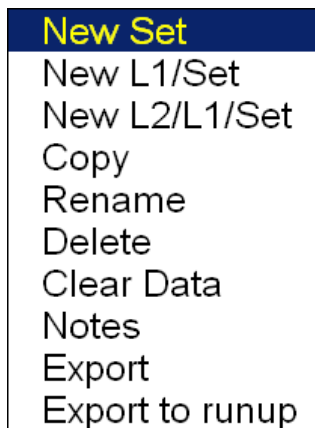

Copy copy of selected item to the new one

Rename renames selected item

Delete erases selected item

Clear Data erases measured data in selected item

Notes see the Route chapter for details

Export copy of selected item to the VA4_DISC, where is accessible for computer.

Export to runup export of selected item to the RunUp mode. Also you can export projects from RunUp mode to the Analyzer mode.

Functions for Set

Next function are available, when the Set is opened (it means the graphs are displayed).

Notes see next chapter

Save data saves last measured data. When you close the Set without saving, the measured data will be lost.

View Trend/ View Actual

The switch button for displaying of last measured data (Actual) and data saved in memory (Trend).

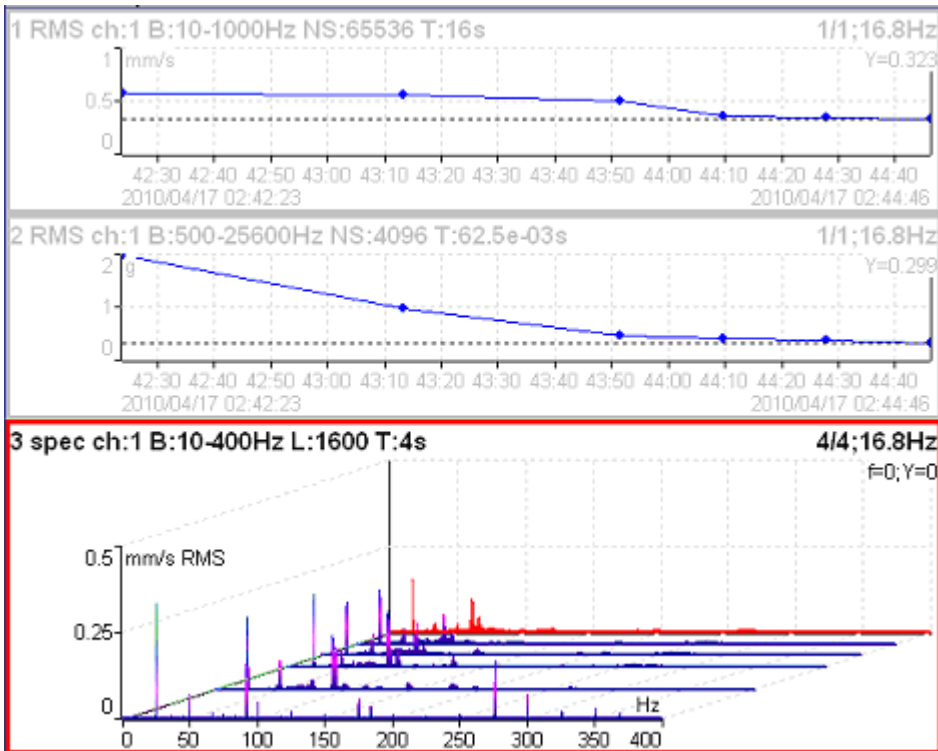

The View Trend example. The trends of overall values is in two top graphs. The cascade graph contains several spectra.

Clear Last Data if the trend is displayed, then it deletes last measured data in measurement point or set (according of displayed data).

Enter speed

This function are available by pushing the bottom left button. This button can have various names depending of mode (Analyzer, Route) and displayed screen (Project, Machine, Set, Point, Meas).

The manual entered speed value will be saved to all next readings. It is saved to the same position in the head of data as the speed measured by tacho. If the speed is manually entered and also measured by tacho, then the tacho has priority and it is saved.

The manually entered speed is displayed on the right side at the top of the screen with the word "Speed:"

Speed: 50 Hz

You should notice, that the speed value is saved to the head of data. That is why you have to use the Tacho factor (Machine or Point Properties) in DDS for recalculation of speed to other ratios.

The Gear Ratio (in Properties) is used with Default Speed value not with the speed value in data head. The Default speed is defined by user in Properties. It is used with machines, which have constant speed (always the same value).

Cancel speed

It cancels (removes) manually entered speed value.

The Cancel speed function is also available in Route.

Measurement Definition in the Set

As has been described already the Set contains definitions of measurements (**Meas**), which we want to take together.

To show the example is the best way how to learn the process of measurement.

The example of requirements for the Set:

Meas 1: RMS overall value in mm/s, frequency band 10-1000Hz, from channel 1

Meas 2: RMS overall value in g, frequency band 500-25600Hz, from channel 1

Meas 3: Spectrum in mm/s, range 400Hz, 1600 lines, from channel 1, number of average 4

Meas 4 Spectrum in g, range 3200Hz, 3200 lines, from channel 1, number of average 8

When the measurements definition is made (see the **New Meas creation** section) everything is ready to make the real measurement. Push the **Start** button (green triangle button). For stopping the measurement use **Stop** button (the red square button). If the **Trigger Mode** is set to single, then only one measurement is taken.

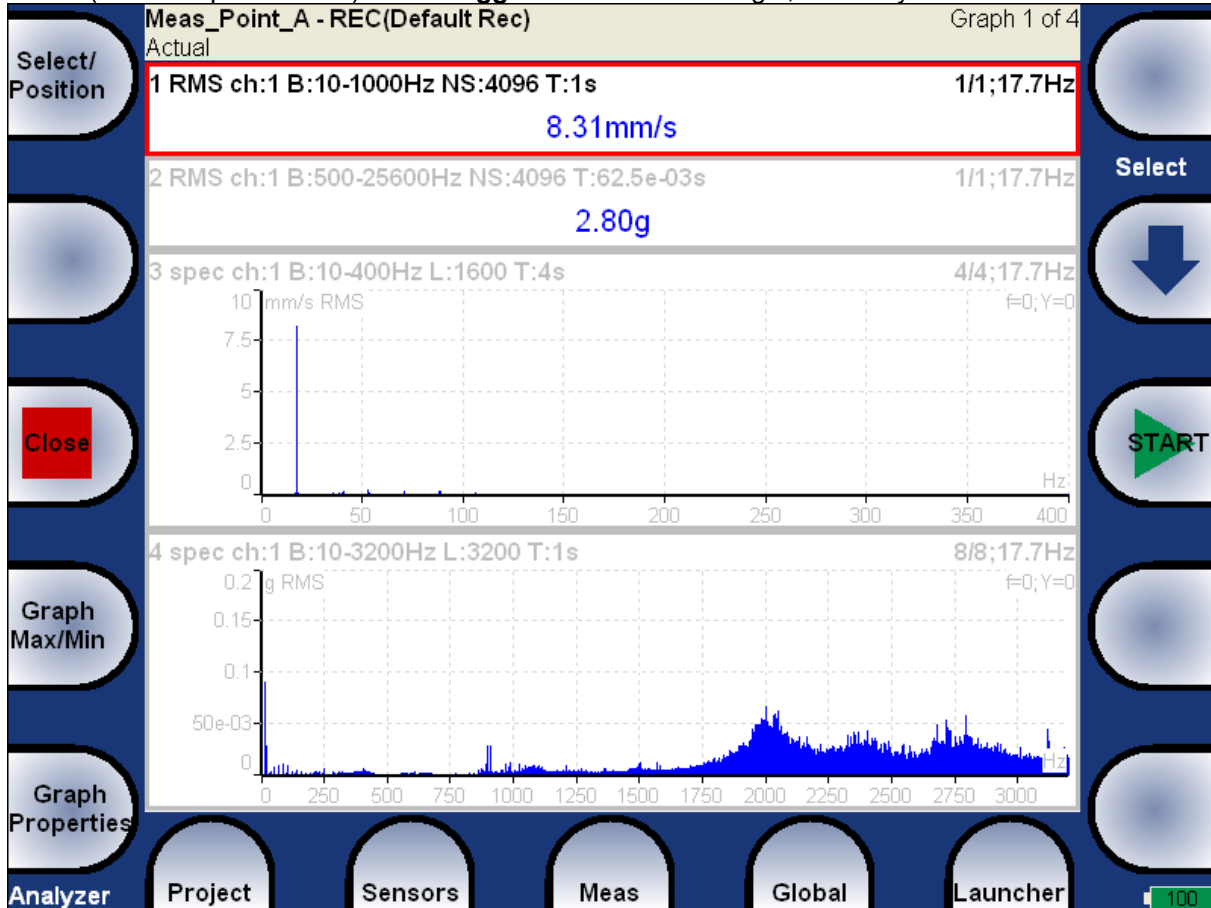

Every graph on the screen contains one measurement. More screens with graphs can be developed.

The description of each graph is in the top.

Example:

1 RMS ch:1 B:10-1000Hz NS:4096 T:1s

The translation: Meas No.1, RMS value, Channel 1, Applied band filter 10-1000Hz, Number of Samples of the signal 4096, Time length of signal 1s. The Signal means the time signal, from which the evaluation was made.

3 spec ch:1 B:10-400Hz L:1600 T:4s

4/4;17.7Hz

The translation: Meas No.3, Spectrum from Channel 1, Range 400Hz, Lines 1600 Time length of signal 4s, 4 signals for 4 AVG used, speed 17.7Hz

Input Buffering

Measured signal is collected into the input memory. The analyze procedures read the signal data from the memory and compute all required results, which are displayed on the screen. In the case, when too many results are required, the computation is slow and displayed graphs are not in time - they are delayed. We are talking about **Real Time (RT)** graphs (you see the actual results) or about **Non Real Time (non RT)** graphs (delayed results).

This information is displayed in the right upper corner - **Measuring RT** or **Measuring non RT**.

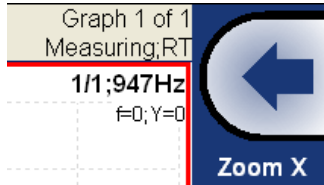

After the measurement is stopped (e.g. by **Stop** button), the computation continues until the input memory is empty. The bellow window appears.

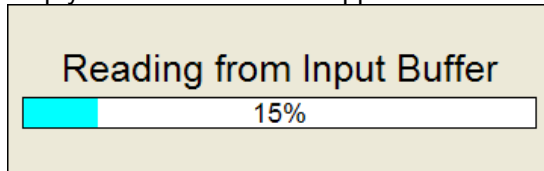

You can wait for all data acquisition or if you are not interested of measurement from input memory press the **Stop** button to stop data processing.

Band fmin[Hz] - HP filtering

Almost in all measurements you should define the HP filtering of input signal. You set it in **Band fmin[Hz]** parameter. You can select the **none**, **1**, **2**, **10** and **user** filter. The **none** value is available only for direct measurement without integration. The **none** value does not mean the DC part measurement. The HP filter on A/D converter is always used. But no additional filter is used. The frequency range with **none** filtering begins on 0.35 Hz (-3dB point). See the response graph.

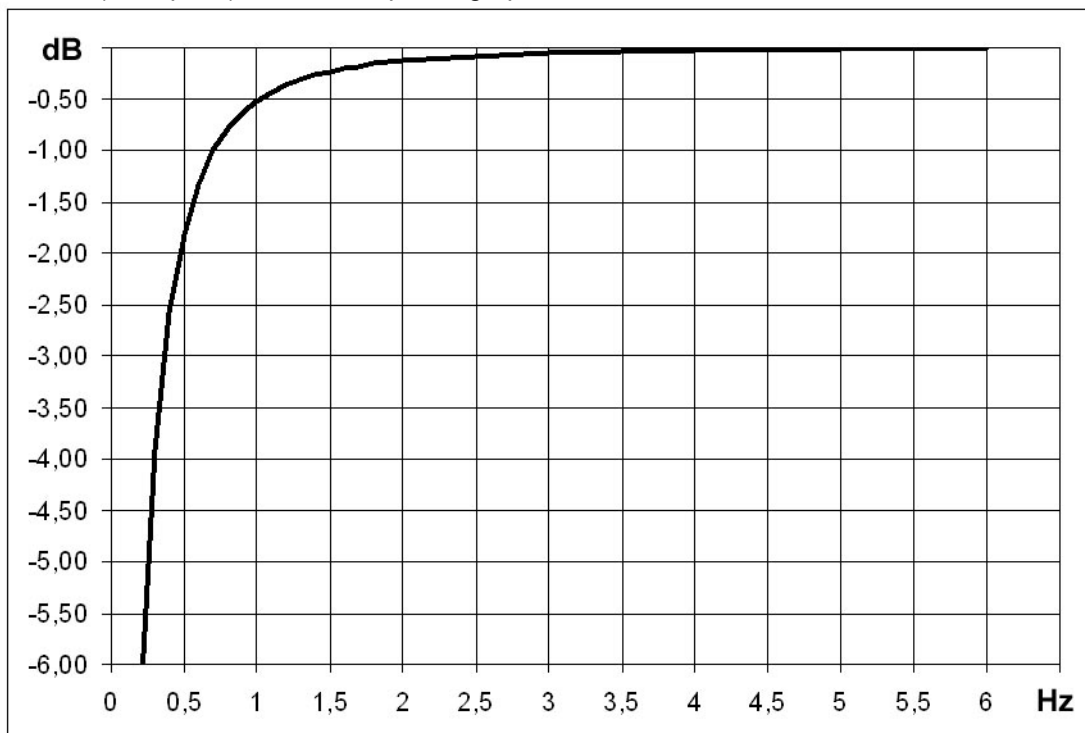

The Analyzer buttons description

The Arrow Mode button

The **Arrow Mode** button switch functions of arrow buttons.

Try to push the **Arrow Mode** button and notice that the left top button changes between **Select/Position**, **Zoom X/Zoom Y** and **Move X/Move Y**.

When the delta or sideband cursor is displayed, then the additional **DeltaX** item appears.

When the measurement from disc are displayed, (**View Trend** function), then the additional **Trend** item appears.

According selected function two right top buttons change their meaning.

Functions for up and down arrows (top right buttons):

Select - moves the selection of active graph

Position - you can change the order of graphs

Zoom - makes zoom-in or zoom-out on vertical Y axe

Move - when the zoom-in is applied, then button move with the signal in defined zoom view vertically

Functions for left and right arrows:

Zoom - makes zoom-in or zoom-out functions on X or Y axe

Move - when the zoom-in is applied, then buttons move with the signal in defined zoom

Delta X - defines the delta X resolution for sideband or delta cursor

Trend - moves on the displayed measurement from disc (history).

The Start, OK button

This right middle button has more purposes and it can :

START the measurement,

OK confirm the selections or entries.

The Stop, Cancel, Back and Close button

This left middle button has more purposes and it can :

STOP the measurement,

Cancel the definition or selection in menu items,

Back moves back in structure of project

Close closes the measurement screen and returns you to the project list

Graph Max/Min

Maximizes or minimizes the selected graph to the whole screen or returns back to the initial screen with more graphs.

Graph Properties

The list of properties is displayed for properties selection. The scale ranges and types (lin, log,...) definitions are the typical use.

!!! Important notice: All available values will be described for every item. But these all values are not visible always. During your work are always displayed only values/choices, which give sense at that moment. E.g. the Axe Z (third) axe is only visible in 3D graphs (e.g.cascade, spectrograph).

Display value, trend

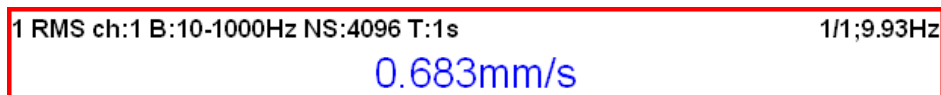

When **value** is used, then last measurement value is displayed (default setting).

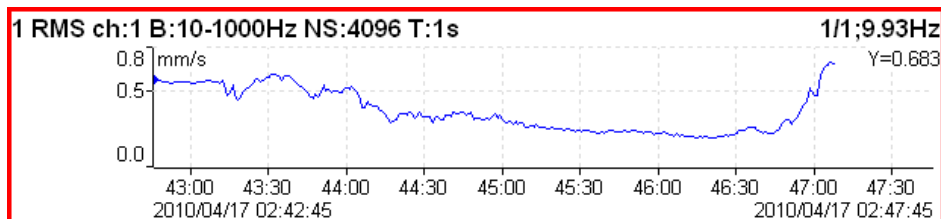

When **trend** is used, the measured values are displayed in the trend.

Scale max Y autoscale for every new graph, but the range is increased when higher value comes
 auto Y autoscale according data values of every new measurement

user user defines Y range for all graphs independently of data values

Cursor for time signals -

- single** standard simple cursor
- periodic** multiplied cursor with several additions of delta time
- delta** band cursor with delta time length

Cursor for spectra -

- single** standard cursor
- harmonic** cursor with several additions of delta
- sideband** cursor with one addition delta
- delta** cursor with one addition delta

Cursor position the time or frequency position of cursor in the selected graph, manual entry available

Delta X the time or frequency interval used for delta cursor computation, manual entry available

Axe X - lin, log

Axe Y - lin, log

Axe Z - **time** scale according time of measurements
speed scale according the speed of machine (tacho must be used)
regular regular scale

Order Z - **first in front, last in front** the order of measurements on Y axe

Detect Type - **RMS, 0-P, P-P** Y axe type

Peaks List - **on, off** the 5 highest spectrum lines table

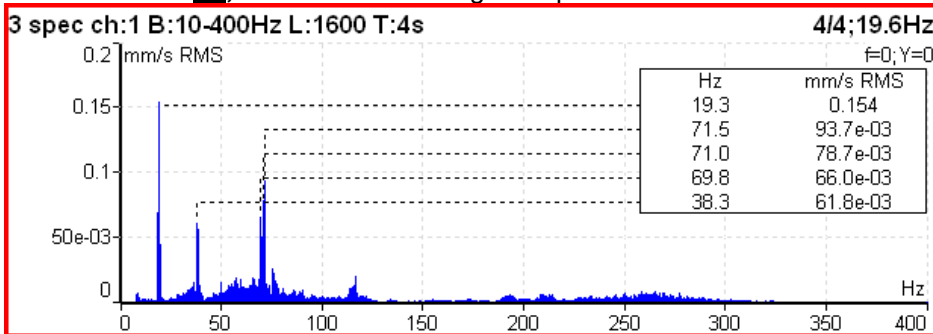

Synch Table **on, off** table of values synchronized with speed and line frequency

- SubSynch - value under speed frequency
- Synch - value on speed frequency and harmonics
- NonSynch - total value decreased of SubSynch and Synch
- Elect - value on line frequency and harmonics (setting in Global Settings / Power/Line Frequency)

All values are in displayed spectrum unit and in % of total value.

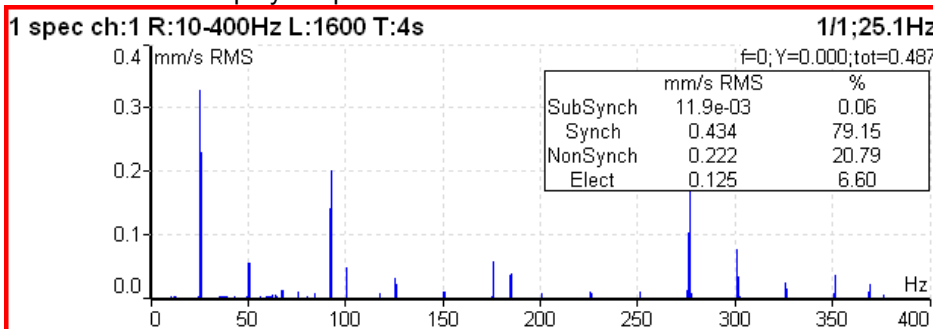

Bearing Faults - if the bearing type (or parameters) is defined and the tacho was used for speed measurement, then the fault frequencies is displayed.

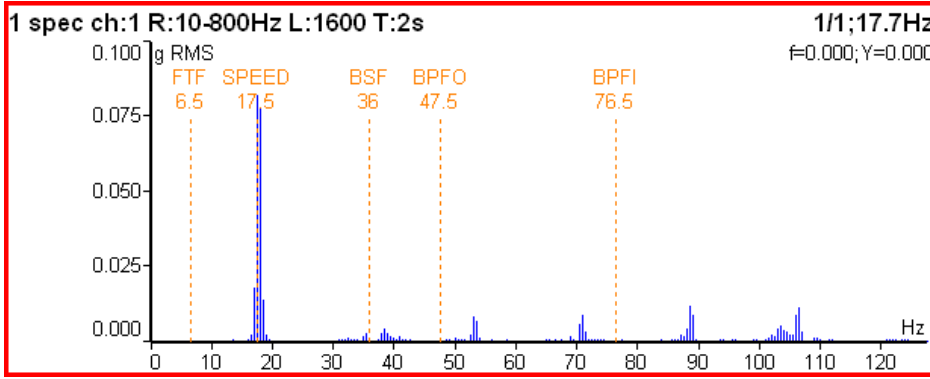

If the tachometer was not used (the measurement does not contain the speed information), then move the cursor to the speed position. The bearing fault frequencies will be displayed according to the cursor position.

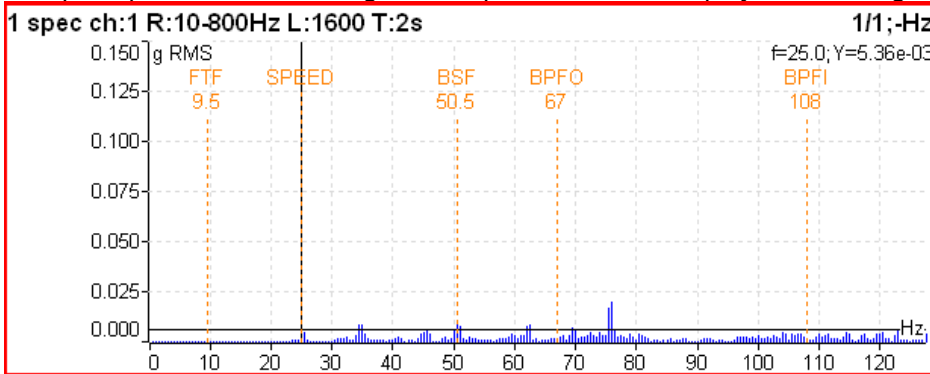

Orders Table - on, off the order values table

Statistics Table the basic statistic values of trend are displayed:

n	number of measurements in trend
EX	mean value (arithmetic average)
σ (sigma)	deviation average
Xmax	maximum value
Xmin	minimum value
Xmax-Xmin	the interval of measured values

Primary Cursor - when the Global/Cursor Type is set to **max**, then is required to select the quantity (graph), to which will be this **max** searching function applied

amplitude, phase, coherence for frequency response (Frf)
X, Y for orbit

View (center line) center line standard 2D center line view, available only for **View Trend**
AB two DC values for **View Actual** or two trends for **View Trend**
XY data transferred to X and Y axes

View (frf) ampl, phase
 real, imag
 nyquist
 amplitude
 phase
 coherence
 time
 amplitudes

View (1x amp+phase) available only for trend
aps t the trends of amplitude, phase and speed related to time of measurement

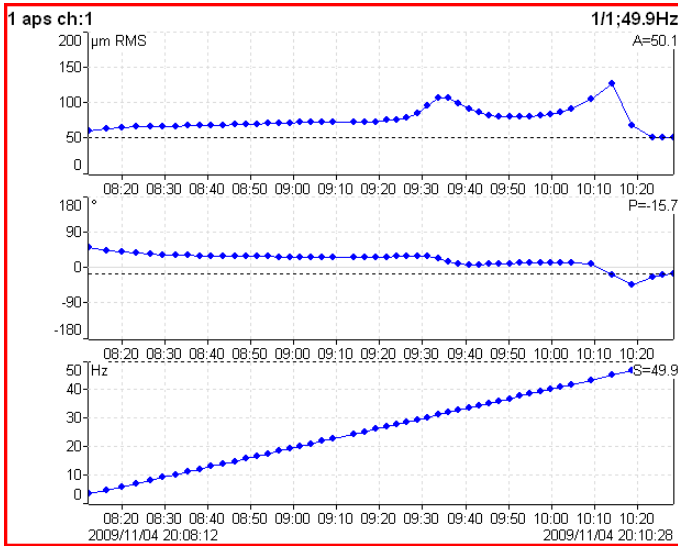

ap_s the trends of amplitude and phase related to speed

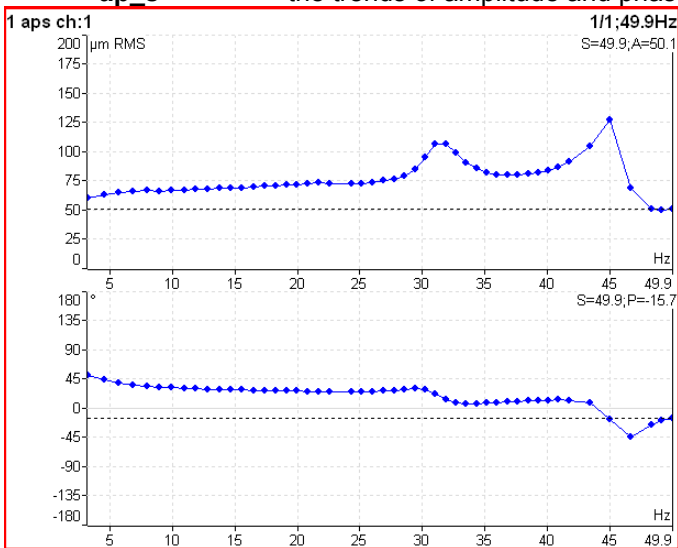

ad_s the trends of amplitude (upper graph) and difference amplitude (lower graph) related to speed, the difference is related to the trend cursor position (in that point is always zero).

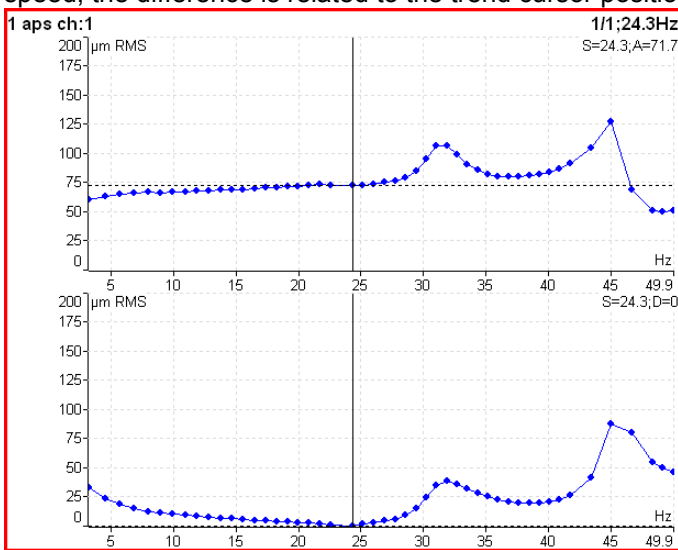

polar 2D complex view

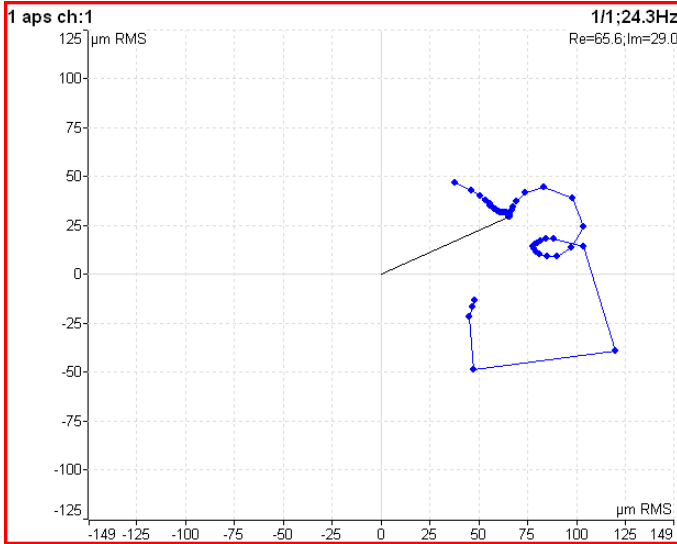

trend3D_t the 3D "tube" view, it is the nyquist graph expanded to Z axe (time scale)

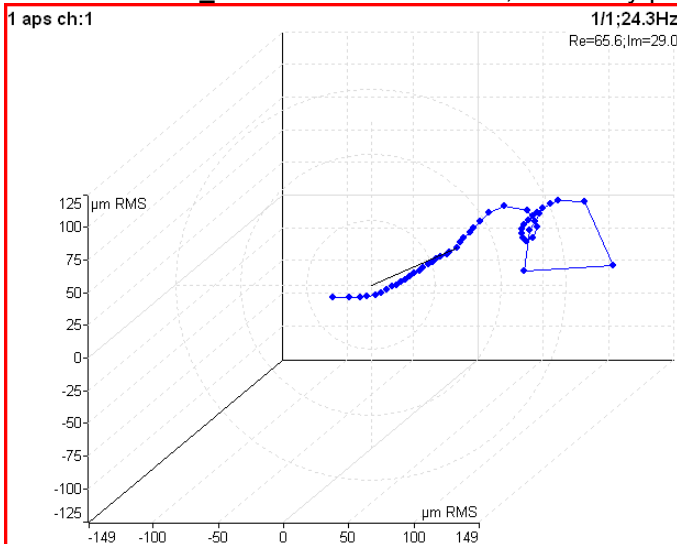

View (phase shift)

- linear**
- polar**

available only for trend
 graph of phase shift, amplitude ratio and coherence related to the time scale
 polar plot of phase shift and amplitude ratio

View (spectrum)- available for trend

- amplitude**
- cascade**
- spectrograph**
- phase**

one spectrum amplitude graph
 waterfall graph
 2D view of amplitudes vs. time
 one spectrum phase graph

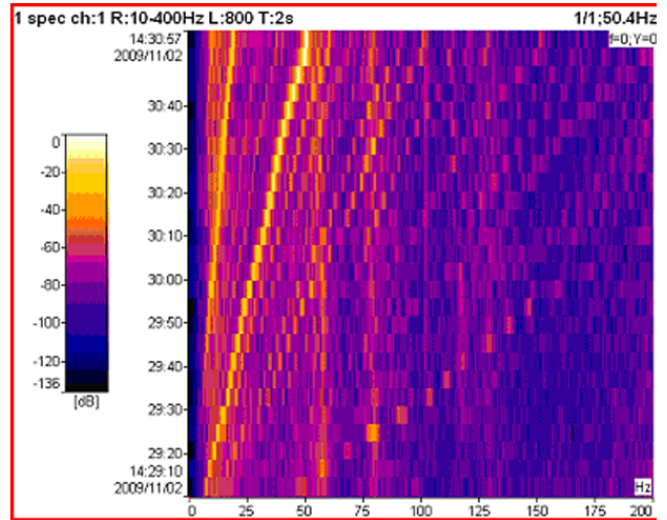
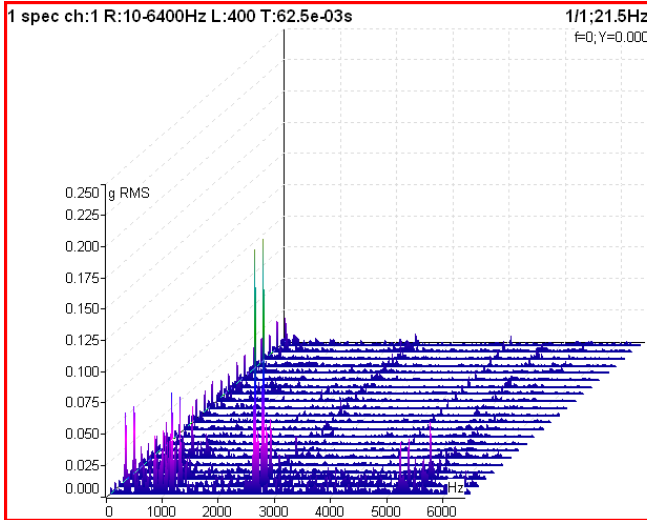

View (spectrum)– available for actual
amplitude one spectrum amplitude graph
time displays the time signal from which the FFT was developed
phase one spectrum phase graph

View (time waveform)
linear standard drawing in Cartesian coordinates
circular circular drawing
Note! When signal contains tacho pulses, then one rotation length is 360° (one circle). If not, then complete signal is drawn only in one circle.

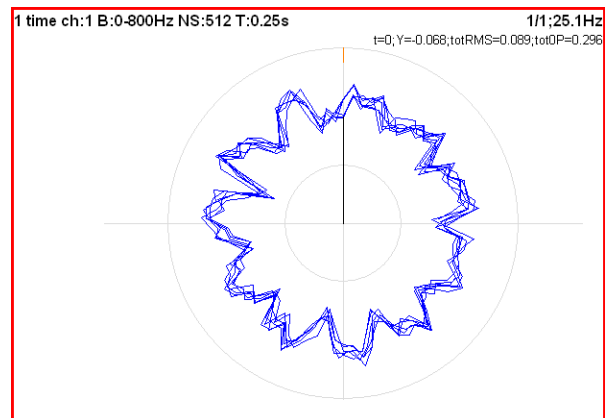
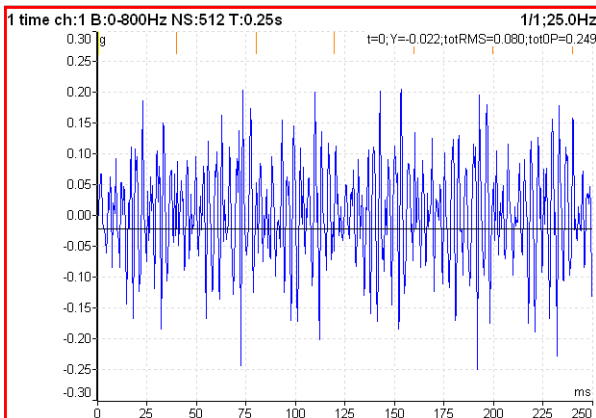

View (orbit)
orbit standard 2D orbit view
AB two input time signals from channels A and B
XY two time signals transferred to X and Y axes

View (filtered orbit)
orbit
orders

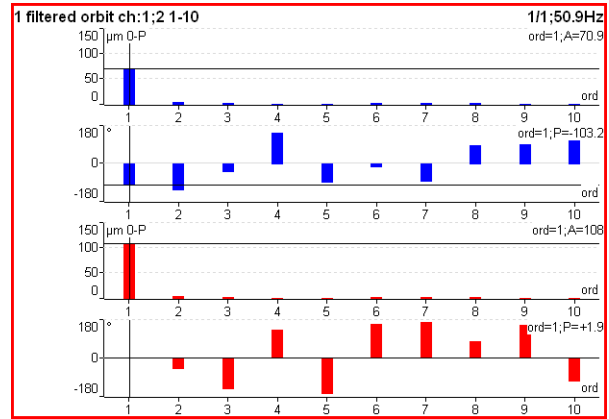
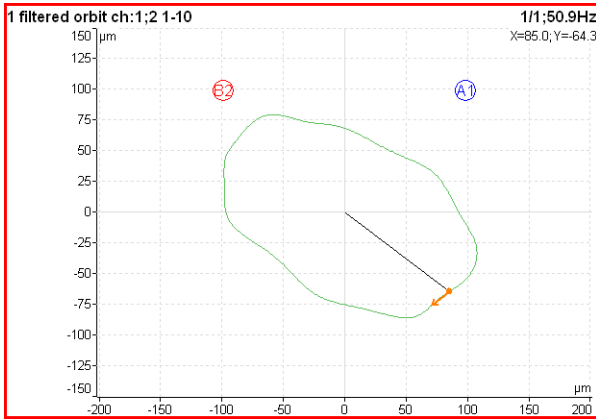

Speed Period on, off the speed time period is displayed

FTF Period on, off the FTF time period is displayed

BSF Period on, off the BSF time period is displayed

BPFO Period on, off the BPFO time period is displayed

BPFI Period on, off the BPFI time period is displayed

Graph Lines continuous, discrete the spectrum can be drawn as line through the tops of line or as discrete vertical line for each frequency

continuous

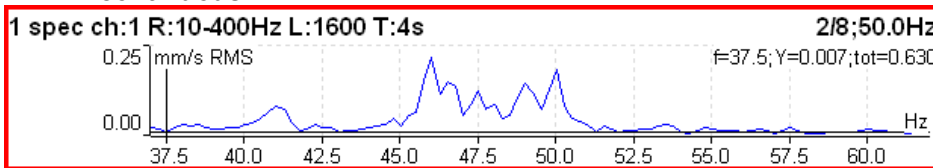

discrete

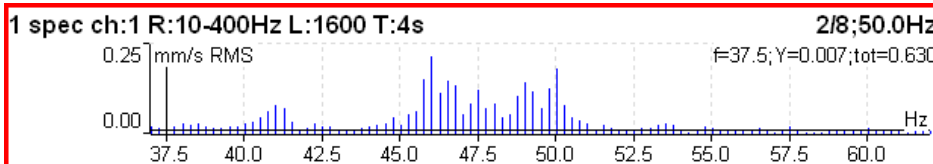

Overall measurement

Type:	wideband freerun, retrig
Channel:	1
Unit:	mm/s
Detect Type:	RMS
Band fmin[Hz]:	10
Band fmax[Hz]:	1000
	fs=4096Hz
Trigger Control:	off
Samples:	4096
	t=1s
Averaging:	linear
Avg:	off
	total t=1s
Save	

This is typical example of overall measurement. The RMS value of vibration velocity in frequency range 10-1000 Hz is measured.

1 RMS ch:1 B:10-1000Hz NS:4096 T:1s 1/1;25.1Hz
0.570mm/s

The first row contains used parameters. The 25.1Hz on the right is the speed, because the tacho sensor was used.

Change the Detect Type to 0-P.

1 0-P ch:1 B:10-1000Hz NS:4096 T:1s 1/1;25.1Hz
1.98mm/s

Note, that the 1.98 is not 1.414 times bigger then 0.570. Some of users mistakenly think, that the formula $0-P = 1.414 * RMS$ is valid for every signal. It is not true. That formula is valid only for pure sine wave ! The true RMS and true peak measurement are generally independent. The only rule is that the peak value is always bigger then RMS value.

Let's change the Avg to 8. The eight individual values (1 sec length) will be taken and the result will be the linear average of them ($RV = (V1+V2+...+V8)/8$). The indication 8/8 is on the right top.

1 0-P ch:1 B:10-1000Hz NS:4096 T:1s 8/8;25.1Hz
2.00mm/s

Let's change the Avg back to off and change the samples number to 32768. The measurement will be 8 sec long.

1 0-P ch:1 B:10-1000Hz NS:32768 T:8s 1/1;25.1Hz
2.12mm/s

You see that the result is different from the previous value. It is clear, the max 0-P value in 8 sec signal is not equal the average of 8 0-P values (which takes 1 sec each).

Let's change the type back to RMS.

1 RMS ch:1 B:10-1000Hz NS:32768 T:8s 1/1;25.1Hz
0.572mm/s

Now change the length to 1 sec (4096 samples) and Avg=8.

1 RMS ch:1 B:10-1000Hz NS:4096 T:1s 8/8;25.1Hz
0.572mm/s

You see the same result. Both values are equal. The meaning of RMS differs from peak values. The RMS value depends only of total time of measurement. It does not care if one long signal was taken or several shorter signals were averaged.

You can define the signal length also in revolutions, not only in samples (=time). The tacho signal must be available in that case.

Type:	wideband <small>freerun_retrig</small>
Channel:	1
Unit:	mm/s
Detect Type:	RMS
Band fmin[Hz]:	10
Band fmax[Hz]:	1000
	<small>fs=4096Hz</small>
Trigger Control:	on
Number of Triggers:	16
Averaging:	linear
Avg:	off
Save	

1 RMS ch:1 B:10-1000Hz R:16 1/1;25.1Hz
0.545mm/s

ISO 10816 overall measurement

The ISO 10816 limit values are also available for overall measurements. The green/ amber-orange/ red point is displayed in front of measured value according the ISO limit.

If you want to use this function you need to define the correct measurement parameters (RMS velocity measurement in 10-1000Hz range) and the group for machine (see Global/ ISO Machine Settings).

1 RMS ch:1 B:10-1000Hz NS:4096 T:1s	1/1;17.7Hz
D 8.30mm/s RMS	ISO 10816: Group1 , Rigid over 7.1mm/s RMS

The color of circle is related to the machine condition class A,B,C,D (the green for A or B, the orange for C and the red for D). Also the information about machine group and foundation are displayed. The limit which is exceeding is also displayed at the bottom.

G-demod overall measurement

Type: g-demod wideband	
<small>freerun, retrig</small>	
Channel:	1
Unit:	g
Detect Type:	RMS
DEMOD fmin[Hz]:	500
DEMOD fmax[Hz]:	25600
<small>fs=65536Hz</small>	
Samples:	8192
<small>t=0.125s</small>	
Averaging:	linear
Avg:	off
<small>total t=0.125s</small>	
Save	

It is very similar to standard overall measurement. The signal is filtered in (DEMOD fmin, DEMOD fmax) range and demodulated then.

The Unit cannot be changed, only the acceleration g unit can be used. No integration of signal is enabled.

1 g-demod RMS ch:1 B:500-25600Hz NS:8192 T:0.125s	1/1;25.1Hz
4.32g	

Time signal measurement

Type: time	
<small>freerun, retrig</small>	
Channel:	1
Unit:	mm/s
Band fmin[Hz]:	10
Band fmax[Hz]:	1000
<small>fs=4096Hz</small>	
Trigger Control:	off
Samples:	4096
<small>t=1s</small>	
Avg:	off
<small>total t=1s</small>	
Save	

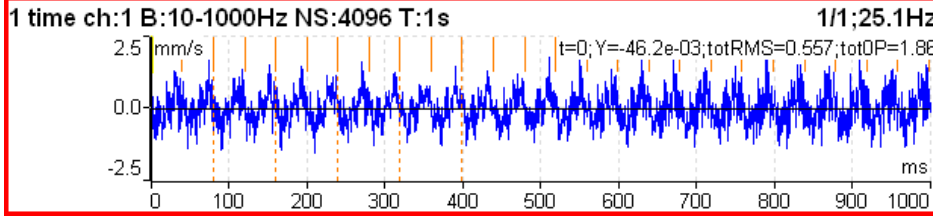

Similar parameter like for overall is used. The red short vertical lines at the top of graph indicates the tachometer inputs.

For averaging you need to set the Global/ Trigger Settings/ Trigger Source = tachometer. Then define the number of averages.

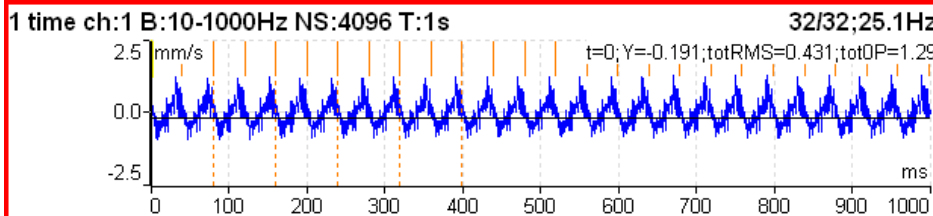

You see the effect of averaging in decreasing of signal noise. The speed frequency is better seen. With the cursor values are displayed also totRMS and totOP values.

G-demod time signal measurement

Type:	g-demod time freerun_retrig
Channel:	1
Unit:	g
DEMODO fmin[Hz]:	500
DEMODO fmax[Hz]:	25600
	fs=65536Hz
Samples:	8192
	t=0.125s
Save	

This function enables to see the signal, when the standard envelope demodulation is used. The Unit cannot be changed, only the acceleration g unit can be used. No integration of signal is enabled.

Orbit measurement

Type:	orbit freerun_retrig
A channel number:	1
B channel number:	2
Unit:	µm
Band fmax[Hz]:	800
	fs=2048Hz
Trigger Control:	off
Samples:	4096
	t=2s
Avg:	off
	total t=2s
Save	

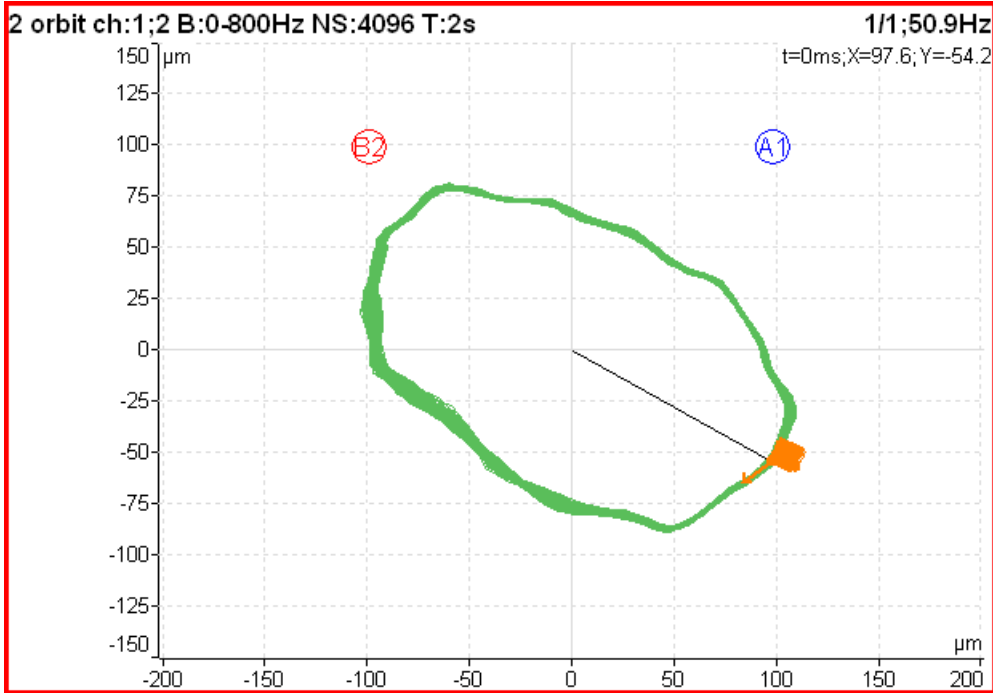

The A1 means, that the channel 1 is used for A orbit channel.

B2 - channel 2 is used as B.

The position of A1 and B2 matches the sensor angles used for measurement (see Sensors definition). The knowledge of those angles enables to draw the correct shape of orbit.

Filtered orbit measurement

Type:	filtered orbit tacho, retrig
A channel number:	1
B channel number:	2
Unit:	µm
Orders:	1-10
Averaging:	linear
Avg:	off
Save	

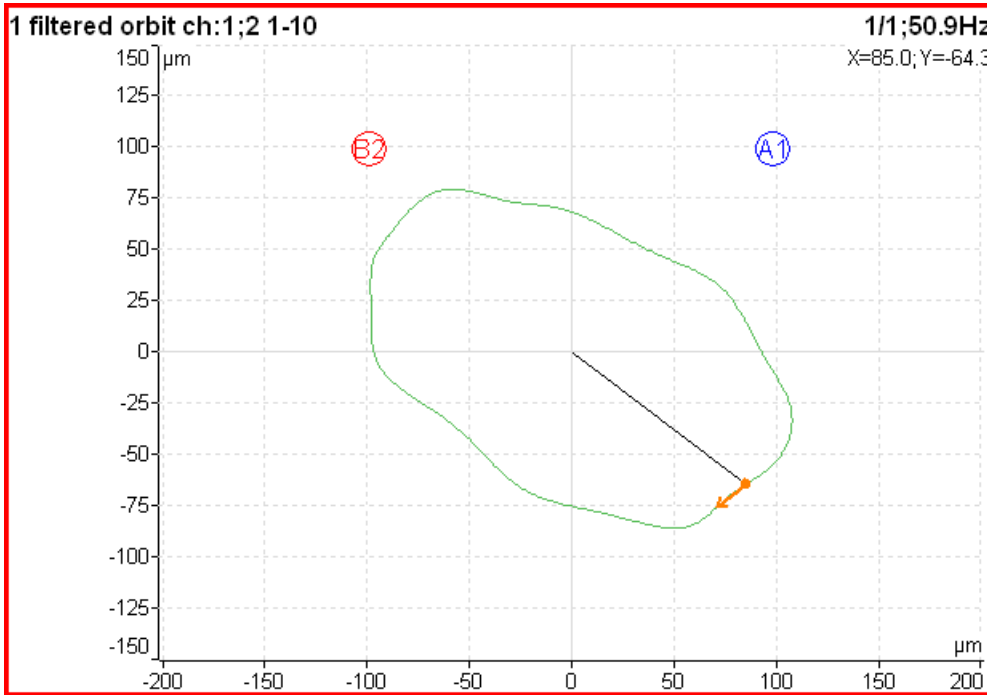

Filtered orbit is built up from two order analysis readings. Correct sensors positions (angles) must be set for correct drawing (as for standard orbit graph).

S-max measurement

Type:	Smax freerun,retrig
A channel number:	1
B channel number:	2
Unit:	µm
Band fmax[Hz]:	800 fs=2048Hz
Trigger Control:	off
Samples:	512 t=0.25s
Averaging:	linear
Avg:	off total t=0.25s
Save	

1 Smax ch:1;2 B:800Hz NS:512 T:0.25s	4/4;50.9Hz
115µm	

It is standard S-max measurement as the maximum vector amplitude of displacement.

Spectrum measurement

Type:	spec freerun, retrig
Channel:	1
Window:	hanning
Unit:	mm/s
Zoom Spec:	no
Band fmin[Hz]:	10
Range[Hz]:	400 fs=1024Hz
Lines:	1600 t=4s, df=0.25Hz
Averaging:	linear
Avg:	8 total t=32s
Overlap:	0%
Save	

The triggering type is displayed below the spec word. The **fs** below the Range means sampling frequency. The **t** below the Lines is the time signal length, which is used for one spectrum. The **df** is the frequency resolution between lines.

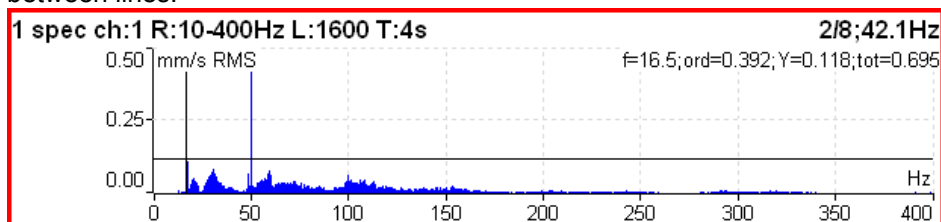

The information in top right contains averaging (2/8), speed (42.1Hz) and below them cursor position (16.5Hz), order ($f / \text{speed} = 0.392$), value (0.132mm/s) and total RMS of spectrum (0.619mm/s).

The **Band fmin** defines the frequency of HP filtering, which is used for DC part removing. If you do not expect any important lines below 10Hz, use the 10 instead 1. The initialization time of 1Hz filter is much longer than 10Hz.

The Overlap enables you to make the averaging faster. E.g. 75% overlap means, that ending 75% of actual time signal + 25% of new signal is used for next average.

G-demod spectrum measurement

Type:	g-demod spec freerun, retrig
Channel:	1
Window:	hanning
Unit:	g
DEMODO fmin[Hz]:	500
DEMODO fmax[Hz]:	25600 fs=65536Hz
Range[Hz]:	800
Lines:	800 t=1s, df=1Hz
Averaging:	linear
Avg:	8 total t=8s
Overlap:	0%
Save	

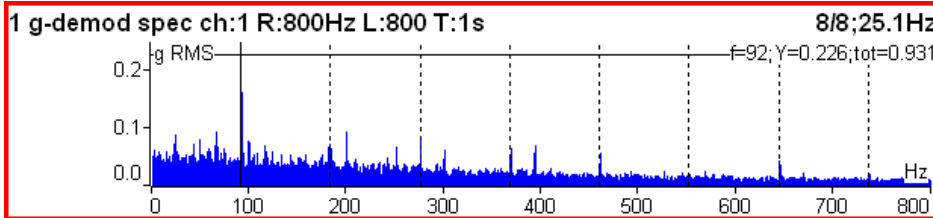

Example: the demodulated frequency 92Hz with harmonics.

The Unit cannot be changed, only the acceleration g unit can be used. No integration of signal is enabled.

Cepstrum measurement

Type:	cepstrum
	freerun, retrig
Channel:	1
Window:	hanning
Unit:	g
Band fmin[Hz]:	10
Range[Hz]:	800
	fs=2048Hz
Lines:	400
	t=0.5s, df=2Hz
Avg:	off
	total t=0.5s
Overlap:	0%
	Save

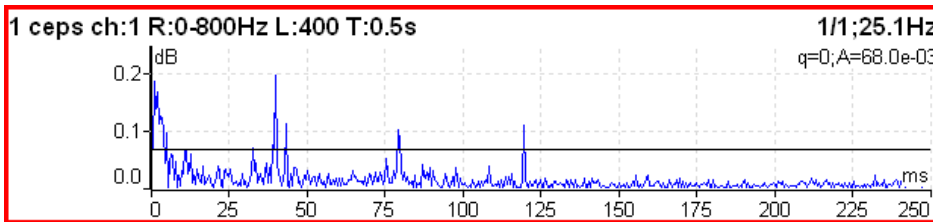

Used algorithm is $\text{cepstrum}(x) = \text{inv}(\text{fft}(\log_{10}(\text{abs}(\text{fft}(x))))))$

- x frequency
- fft fourier transform
- abs absolute value
- log10 common logarithm
- inv inverse function

Speed measurement

The machine speed (revolutions) is measured.

When the tacho sensor is used (connected to the tacho input), then the impulses is added to all AC inputs. In the time signal graph are marked by short red lines.

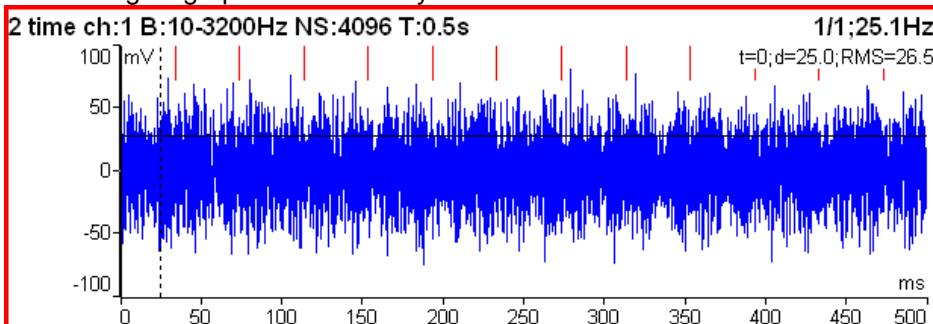

Type:	speed freerun, retrig
Unit:	Hz
Averaging:	linear
Avg:	off
Save	

1 speed	25.1Hz	1/1
---------	--------	-----

The speed measurement is taken 8 times in every second. The value is evaluated from 3 tacho events in time signal. When the averaging is required, then more values is used. But keep in mind that only 8 values is taken in one second.

ACMT measurement

See the Appendix A for detailed description of ACMT method.

Type:	ACMT freerun, retrig
Channel:	1
Unit:	g
Band fmin[Hz]:	500
ACMT FS[Hz]:	1024
Samples:	4096 t=4s
Save	

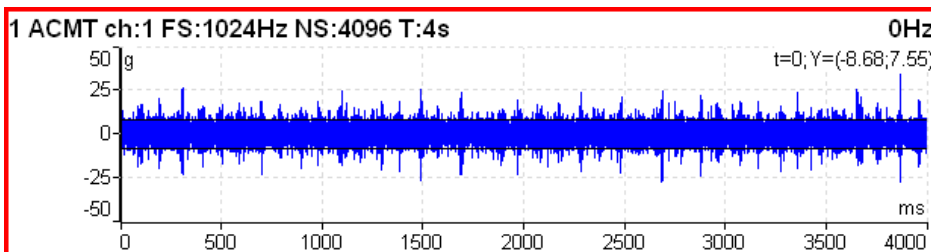

Orders measurement

This name means order analysis.

Type:	orda freerun, retrig
Channel:	1
Unit:	μm
Orders:	1-10
Averaging:	linear
Avg:	off
Save	

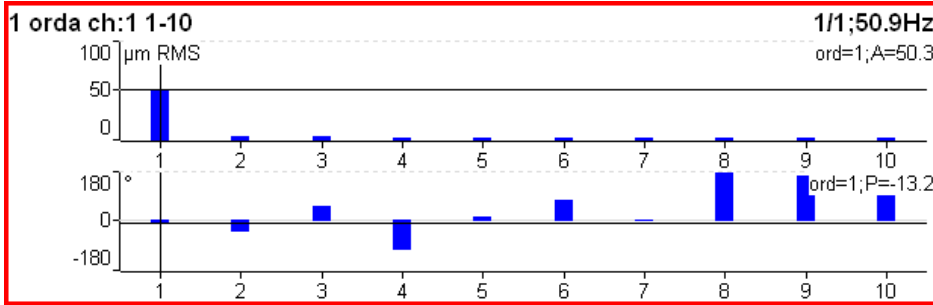

1x amp+phase measurement

Type:	aps freerun, retrig
Channel:	1
Unit:	μm
Averaging:	linear
Avg:	off
Resolution:	speed / 4
Save	

1 aps ch:1 1/1;49.3Hz
50.0μm RMS; -18.5°

The smaller resolution means longer time signal for evaluation. We do not recommend to use always the minimum value (speed/64), because you will wait for results longer (much longer). Use the small resolution only in cases, when your signal contains two close frequencies and you need to separate them. For 50Hz speed the speed/4 means the band (43.75Hz, 56.25Hz) and the speed/64 means (49.61Hz, 50.39Hz).

Phase Shift

The measurement of phase shift (between two channel A and B), amplitude ratio and coherence on speed frequency (with tacho) or manually entered frequency.

See the **New Advanced** chapter for more information about **Resolution** item.

Type:	phase shift freerun, retrig
A channel number:	1
B channel number:	2
Avg:	off
Frequency:	speed
Resolution:	speed / 4
Save	

1 phase shift ch:1;2 f:speed 4/8;50.0Hz
ΦB-ΦA:+140.2°; B/A:2.02; coh:0.912

The result contains:

- phase shift value in degrees,
- amplitude ratio (ampl B/ ampl A),
- coherence

If the phase shift is reliable, then the coherence must be bigger then 0.8.

Frf - frequency response function

Type:	fresp freerun_retrig
Input:	1
Window:	transient
Shift[ms]:	97.2
Length[ms]:	6.35
Output:	2
Window:	exponential
Shift[ms]:	97.7
Length[ms]:	196
Result Type:	H1
Range[Hz]:	800
	fs=2048Hz
Lines:	800
	t=1s,df=1Hz
Avg:	4
	total t=4s
Overlap:	0%
Save	

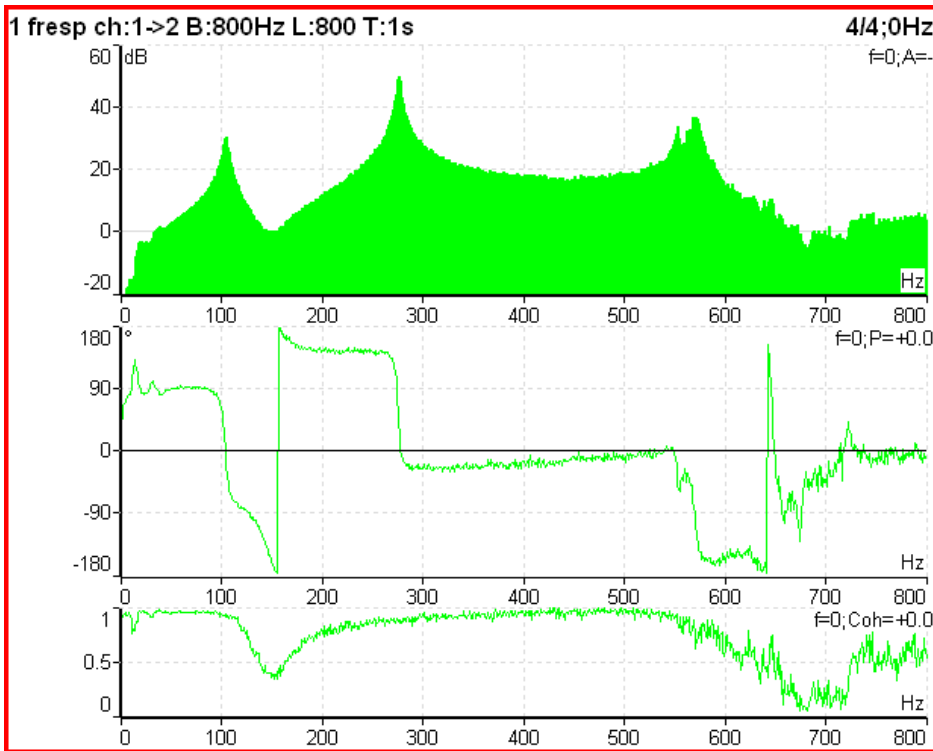

From ver.2.32 is the coherence displayed in the amplitude graph. The short horizontal line on Y axe is on position of value=1 for coherence.

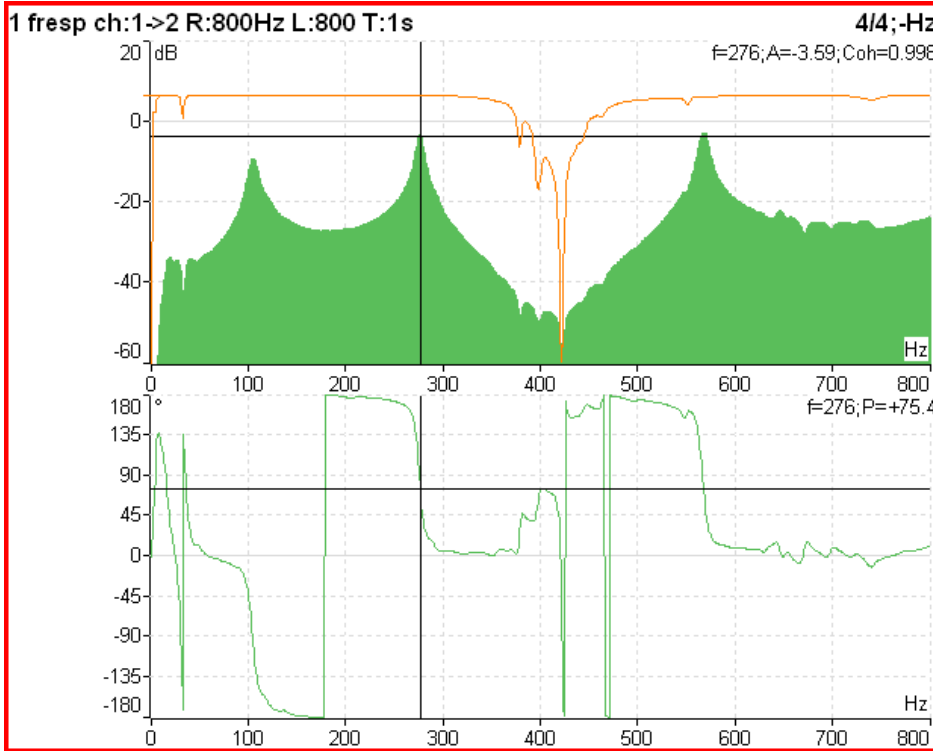

This display is created by this Graph Properties.

Cursor Position [Hz]:	0
Scale:	auto
Axe X:	lin
Axe Y:	dB
Range[dB]:	80
Fresp View:	ampl,phase
Primary Cursor:	amplitude
Save	

When you set the Frf view to **time**, you see the time signals from both channels. When you use the hammer, the remember to set the **Trigger Settings/ Trigger Source** to **amplitude**, the **Pretrig** to e.g. 25%, select **Ampl Trig Channel** number and the **Ampl Trig Level** value.

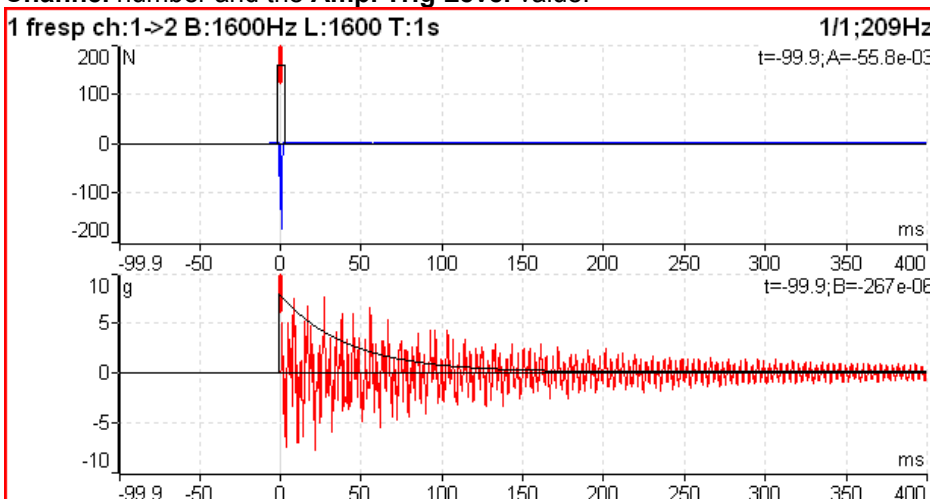

Use the **Arrow mode** button and set **Shift** or **Length** top right buttons. Now you can simply shift with FFT windows or change the length. When you use the **Shift1** button, you change the **Shift1** to **Shift2** or to **Shift12** (shift both windows together) by using the top left button **Shift1/Shift2/Shift12**. The frf function do not use the any HP filter. If you want to compare the time signal from frf with standard time signal, you must set the **Band fmin** to none.

DC measurement

The direct DC signal can be measured by this function.

Type:	dc freerun, retrig
Channel:	1
Unit:	μm
Averaging:	linear
Avg:	off
Save	

1 dc ch:1	1/1;-Hz
919 μm	

The DC1 sensor must be set according the required unit.

Sensitivity[mV/μm]:	-8
Offset[mV]:	-4000
Unit:	μm
Position[°]:	-45
Save	

This set correspond the usual eddy current sensor (proximity). Each μm of distance between sensor and metal surface (shaft) adds 8mV of negative voltage. The -4V (-4000mV) level is zero distance. See examples in table.

distance	voltage
μm	mV
0	-4000
100	-4800
500	-8000
1000	-12000

Center line measurement

This measurement is often used for turbines. The **Center line** values define the static position of shaft in bearing.

The signals from proximity sensors must be connected to DC channels. We need to remove the AC part and to hold the DC part. The DC inputs work in that way.

Type:	center line freerun, retrig
DC A channel number:	1
DC B channel number:	2
Unit:	μm
Avg:	off
Save	

The Center line is related to the orbit measurement. We also need to sensors with known angles of mounting. While in orbit we see the shape around the (0,0) position, in the center line we see the position of shaft center without shape of orbit.

1 center line ch:1;2	1/1;-Hz
A:2767 μm ; B:1768 μm ; X:-706 μm ; Y:-3206 μm	

Two couples of values are displayed - A+B and X+Y. The A,B values represent distances of sensors from the reference position defined by offset value. The X,Y values represent that positions according the Cartesian X,Y coordinates (The position (0,0) correspond the position, where A,B are equal their offsets). The polar graph is displayed for trend.

Octave Spectrum

All parameters are described in Octave Analysis chapter. The exponential averaging is not available in Analyzer mode.

Fasit

Type: fasit freerun, retrig
Channel: 1
Save

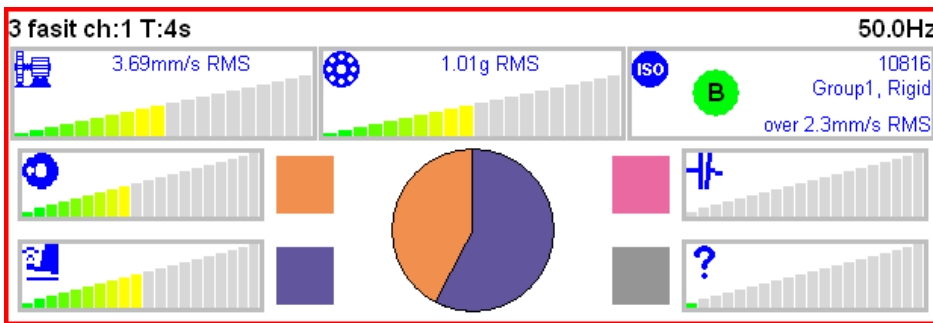

If the FASIT is measured, the speed detection is done before the measurement itself (see the Speed detection chapter).

Note: The speed can be assigned in advance (functions Enter Speed or DDS Default Speed). In those cases the speed detection does not take place.

There is detailed description in the FASIT mode chapter.

Ultrasound

Type: ultrasound freerun, retrig
Save

1 ultrasound	-Hz
Level: 52 dB, Shock Factor: 1.4	

Two values are displayed. The **Level** of sound in dB (30-50kHz range) and **Shock Factor**. The Shock factor is defined as Peak value divide by RMS value. It means value 1.4 for pure sine. Higher values means that transient shock events are in the sound signal.

Note: The ultrasound sensor (microphone) required.

There is detailed description in the Ultrasound mode chapter.

Record

Type:	record freerun, retrig
Sampling Frequency[Hz]:	65536 Range=25600Hz
AC1:	on
AC2:	off
AC3:	off
AC4:	off
DC1:	off
DC2:	off
DC3:	off
DC4:	off
Trigger Channel:	on
Time[minutes]:	1
Start of Rec:	freerun
Save	

1 record

00:00:25 / 00:01:00

Creates and saves the record. After the download to PC it is ready for using with VA4_Virtual Unit (see the **A4410 Virtual Unit** chapter).

There is detailed description in the Recorder mode chapter.

The Balancer

Introduction

The balancing process is based on standard measurements of amplitude, phase on the speed frequency. The VA4Pro balancer includes many special internal functions, which remove the influence of noise, speed changes etc. If you are not familiar with field balancing method, please see any special literature.

The Project

The Project is the base structure in balancer. It corresponds of one balancing job. You can use the same Project for repeated jobs on the same machine. The measured data will be re-written.

The Project contains all measured or entered data, which were be used during the job. The typical scheme looks like next list of steps:

- Project name enter.
- Mode (machine type and number of planes) enter.
- RUN 1 - Initial measurement of vibration amplitude and phase in required number of planes.
- Trial mass put on the rotor. Step by step to all planes.
- RUN 2 - Trial mass response measurement. Step by step to all planes.
- Final masses put on all planes.
- RUN 3 - Check of effect (success) measurement.
- Trim measurements for additional masses and better results.

The Project Screen

Every step is displayed in one screen.

The movement between screens is provided by up/down arrows.

The usual Enter button is not used, it could confuse the user. The movement enables to return back anytime. The important property must be clearly told. When you return back in the job screens and you take again repeated measurement or value enter, then the measured data will be erased in all screens after actual screen. The reason is simple. The implications are derived from every screen to the next screens. When you repeat the measurement, you change the parameters for those implications. That is why all next screen implications must be removed and you have to make all necessary measurements again.

The first screen

The list of saved projects or the Empty label is displayed on the first screen. The time and date of last saving of selected project is displayed in top right corner.

Select one project or use the **Project** button for **New** project creation.

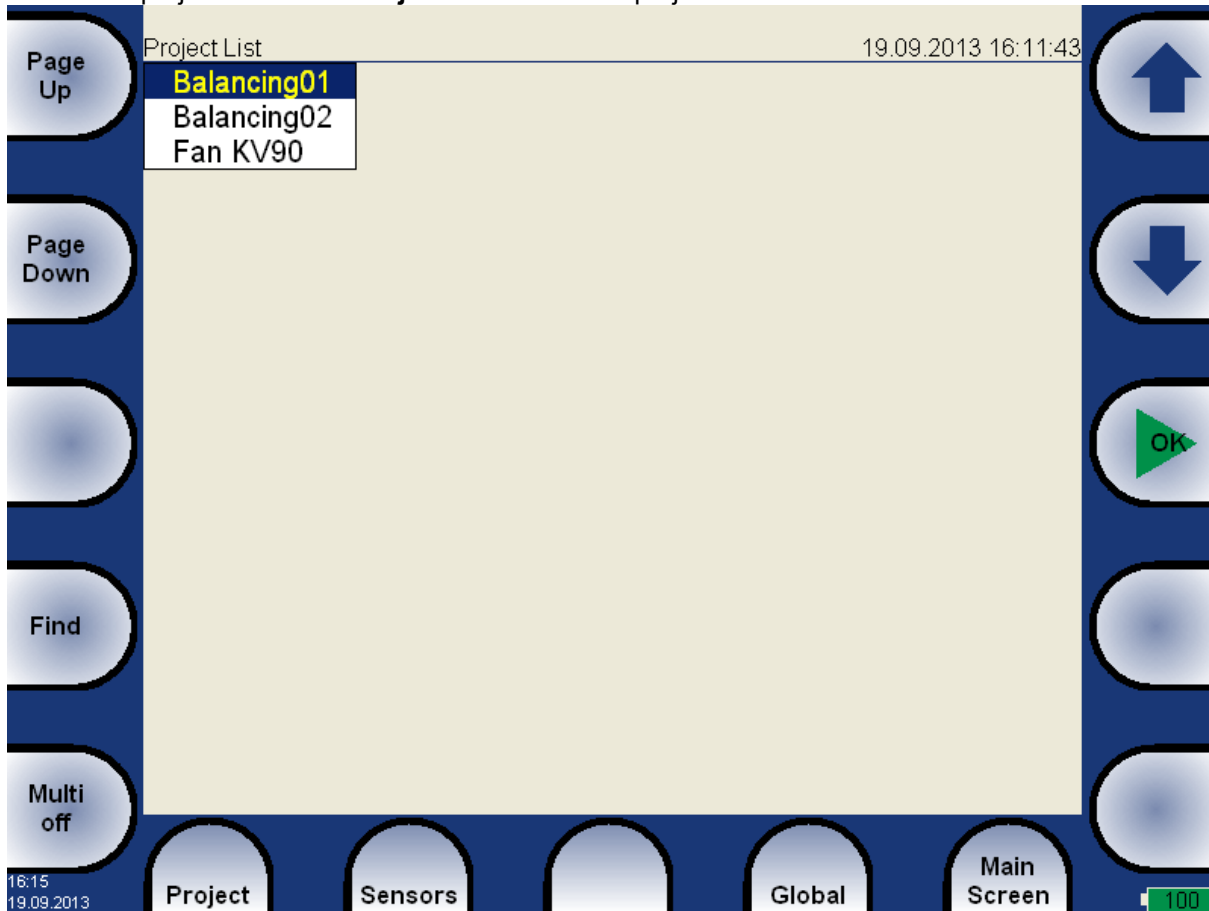

Also next functions for projects managing are enabled.

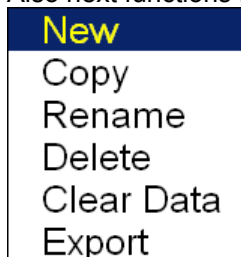

New when you select the New item, then you will enter the name of new project. The screen for manual entry was in details described in **Menu - how to work with ...** section.

Copy creates the new project as the copy of selected project (like Save As function in MS Word). Only the header data are saved (machine name, balancing type,...). No measured data are saved.

Rename renames the selected project. The project with old name does not exist anymore.

Delete deletes selected project.

Clear Data erases all measured data, only the project header remains in unit.

Export exports selected project to VA4_DISC.

Next functions are available for opened project.

Balancing Report
Balancing Vectors
Total Mass

Balancing Report creates balancing report in rtf format (MS Word) and save it to VA4_DISC for PC downloading.

Balancing Vectors the drawing of amplitude/phase vector development during the balancing process. The drawing is also included to the balancing report.

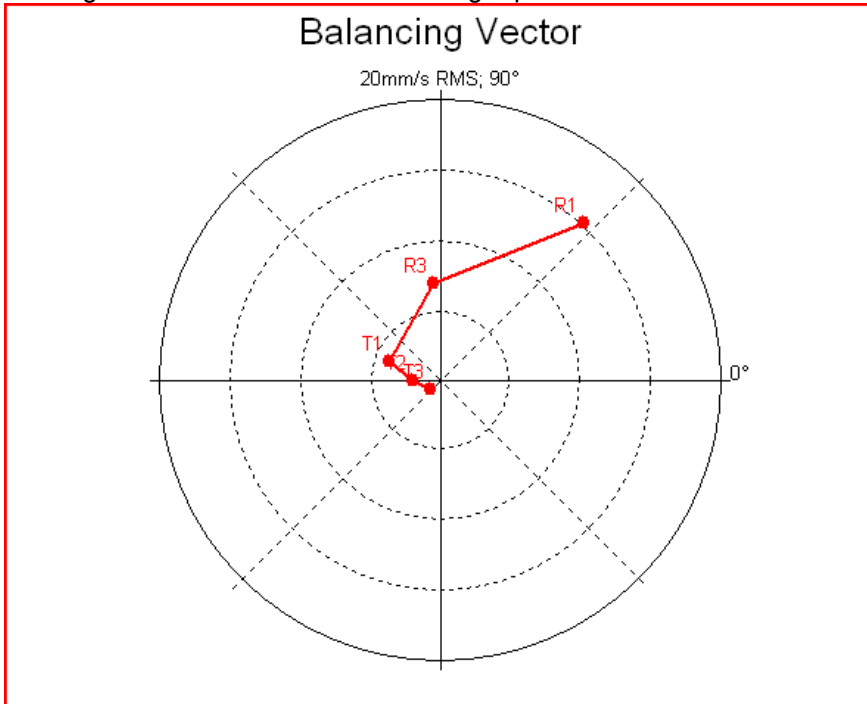

Description: R1-RUN1, R3-RUN3, T1-T3 -trims 1-3.

Total Mass displays the total balancing mass. It is the vector sum of all masses mounted to the rotor (basic+all trims).

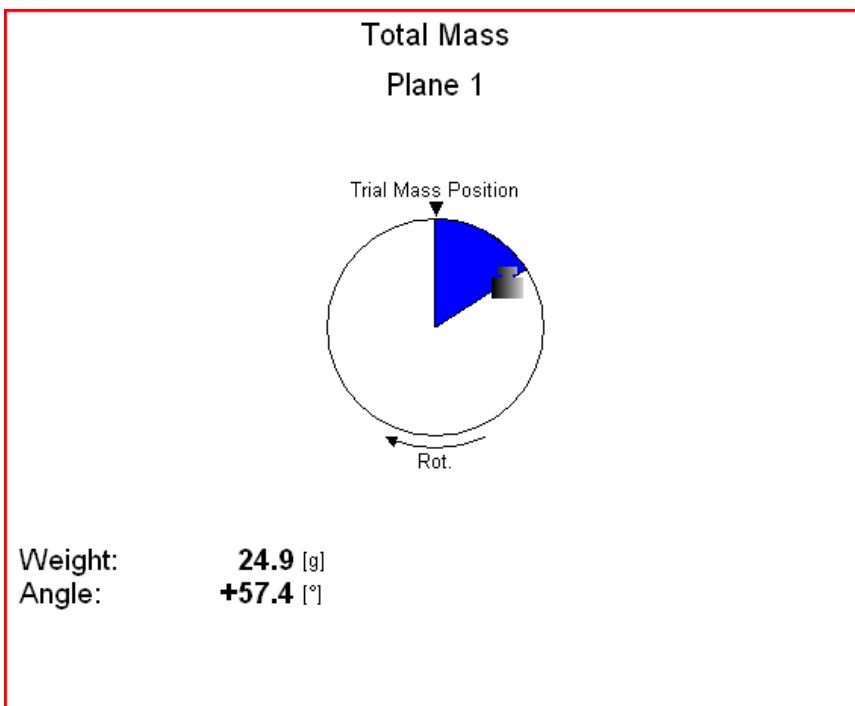

New project

Push the **Project** button and select the **New** item. Enter the name of project. The new project is added to the list of projects and it is selected (active in dark color). Press **OK**, it will be opened. The list of basic properties appears. Define your values and press **OK**.

Balancer Settings

All project properties are defined under this button. When you push it, the menu with several items appears.

Basic Settings

Planes:	single
Image:	overhung rotor
Look:	left
Rotation:	CW
Channel:	1
Balancing Masses:	add (mount)
Blades:	not used
Meas Mode:	single
Avg:	off
Resolution:	speed / 4
Save	

Planes:	dual
Image:	2 outside rotors
Rotation:	CW
Inputs:	dual
Channel A:	1
Channel B:	2
Remove Trial:	yes
Balancing Masses:	add (mount)
Blades:	not used
Meas Mode:	single
Avg:	off
Resolution:	speed / 4
Save	

Planes	single, dual	plane(s) balancing
Image	selection of machine image, different images are available for single and dual plane balancing	
Look	left, right	view direction (only for single plane balancing)
Rotation	CW, CCW	clockwise or counterclockwise
Inputs	single, dual	one or two AC inputs (sensors) can be used (only for dual planes balancing)
Channel	1-4	the number of AC input, which will be used for sensor mounted on the bearing (only for single plane balancing)
Channel A	1-4	the number of AC input, which will be used for sensor mounted on the bearing A (only for dual planes balancing)
Channel B	1-4	the number of AC input, which will be used for sensor mounted on the bearing B (only for dual planes balancing)
Note: The bearing marking A and B has only the symbolic sense. It has no relation to the balancing planes 1,2 and to the balancing computational procedure. You can mark any bearing as A and the second as B.		
Remove Trial	yes, no	the trial masses can be left on the rotor or removed after the trial run. When the trial mass is kept on the rotor, then must be included into final mass figuring (choice available only for dual planes balancing, for single plane are both results displayed together)
Balancing Masses	add (mount) / remove (drill)	

- Blades** the number of blades (for rotors with blades). This parameter is used in job figuring to split the mass to blades.
- Meas Mode** **single, online meter** when you push the **Start** button, then only one measurement value can be taken (single) or the continual measurement values displayed (online meter). In online meter mode you can look at more values and to evaluate the changing of them in time. You need to **STOP** the measurement, when is displayed the value, which you want to use.
- Avg** the averaging of more then one measured values is available
- Resolution** read the explanation in the Meas functions/ New Advanced section.

Units Settings

Amplitude:	mm/s
Detect Type:	RMS
Speed:	RPM
Mass:	g
Save	

- Amplitude** selection from available units for used sensor
- Detect Type** **RMS, 0-P, P-P**
- Speed** selection from available units for speed
- Mass** selection of unit for mass

Rotor Settings

Rotor Mass[kg]:	-
Correction Radius[mm]:	-
Balance Quality Grade:	-
Save	

- Rotor mass** rotor mass in kg
- Trial radius** radius to which the balancing mass will be mounted
- Balance Quality Grade** the value, which is defined by rotor type according ISO1940
- All parameters are optional. It enables to calculate balancing quality factor according ISO1940.

RUN 1 screen

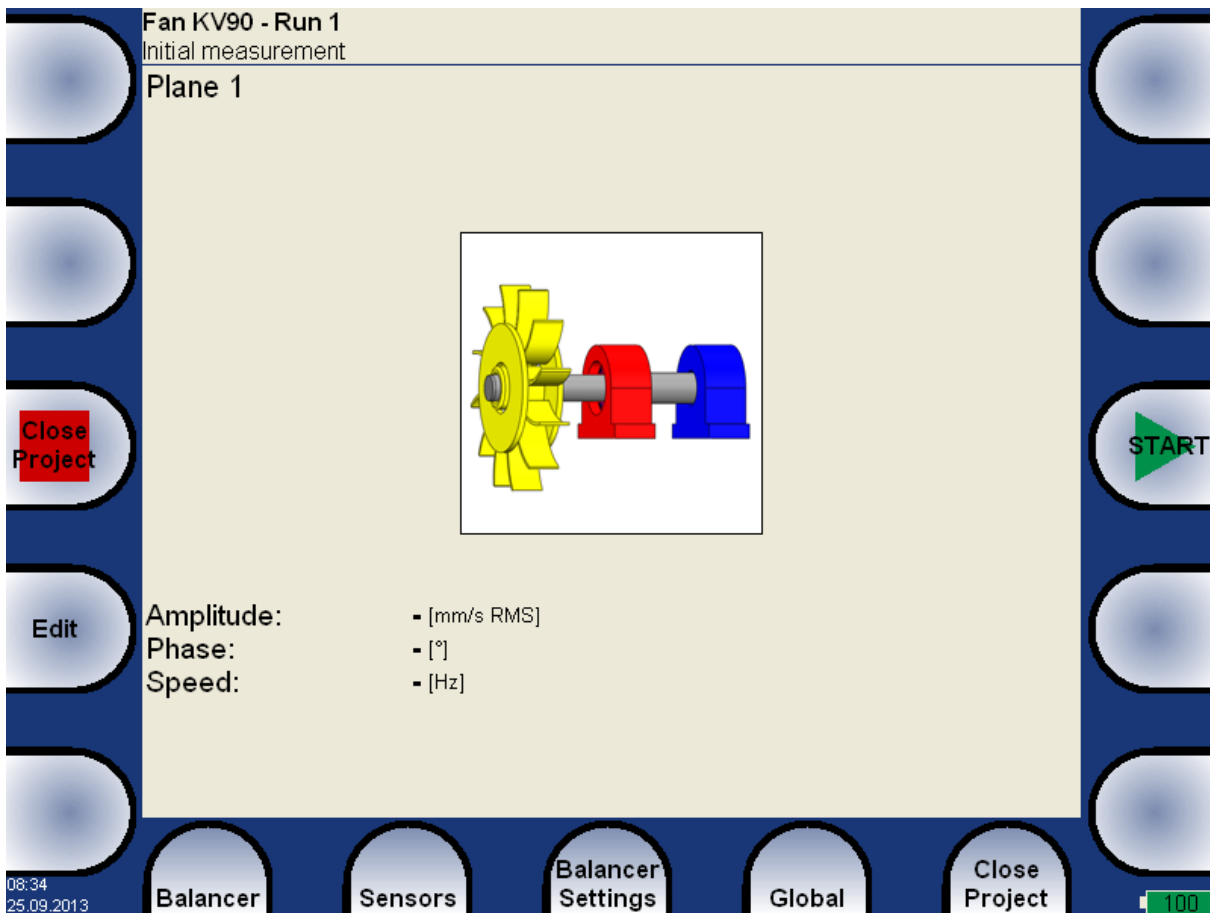

The red bearing house is the recommended point for sensor mounting. But you can use any other place, which is suitable for measurements.

Press **START** button and measurement will be taken.

If you press the **Edit** button, then you can manually enter all values (balancing calculator function). Use the **Tab** for shift between values.

Amplitude:	12.5 [mm/s RMS]
Phase:	+56.0 [°]
Speed:	25.0 [Hz]

Use the **down arrow** to move to the next screen.

RUN 2 - the TRIAL MASS screen

The trial mass mounting and response measurement is required to take on RUN 2 screen.

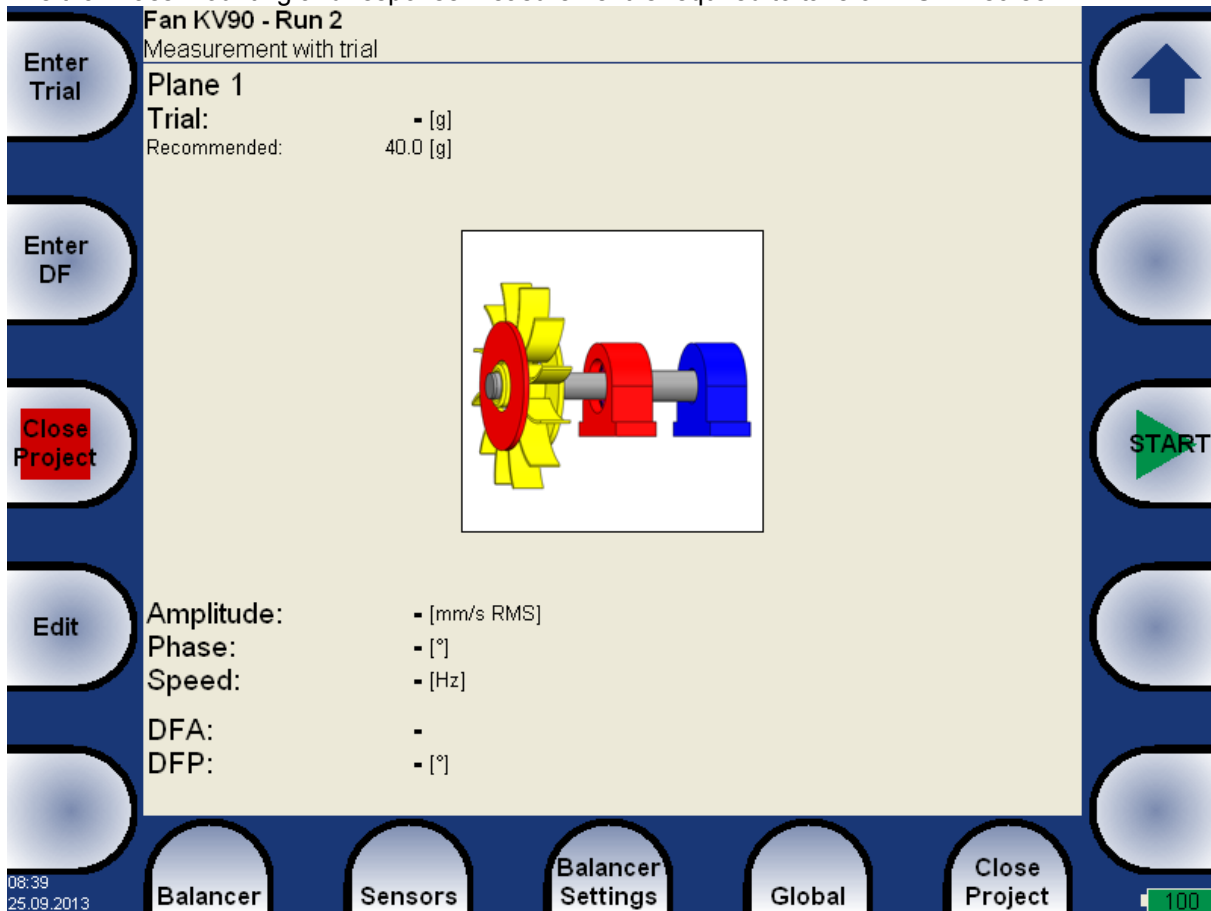

Push the **Enter Trial** button and enter the weight of trial. Confirm by **OK**. The weight can be negative, it represents removing of mass (for example dismounting of old balancing mass). The recommended weight is displayed only if the **Rotor settings** parameters are entered.

Push **START** button for measurement.

Push **Edit** and all values can be manually entered (balancing calculator function). Use **Tab** (in left) for cursor movement.

Amplitude:	19.0 [mm/s RMS]
Phase:	+145.0 [°]
Speed:	25.0 [Hz]

After the RUN2 measurement the dynamic factor is displayed. The **DFA** and **DFP** (amplitude and phase) values are the response values of standardized trial mass (mm/s_{RMS} / 1kg regardless the selected unit for balancing). If you will balance the same machine again after some time, then you do not need to measure the RUN2. Instead of that you only will enter the DFA,DFP values in this screen. Use **Enter DF** button for that.

DFA:	501
DFP:	+178.6 [°]

Fan KV90 - Run 2
Measurement with trial

Plane 1
Trial: **45.0** [g]
Recommended: 40.0 [g]

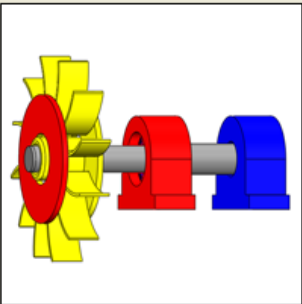

Amplitude: **19.0** [mm/s RMS]
Phase: **+145.0** [°]
Speed: **25.0** [Hz]
DFA: **501**
DFP: **+178.6** [°]

08:40
25.09.2013

Balancer Sensors Balancer Settings Global Close Project

100

Enter Trial
Enter DF
Close Project
Edit

↑
↓
START

Use the **down arrow** to move to the next screen.

RUN 2 - the RESULT screen

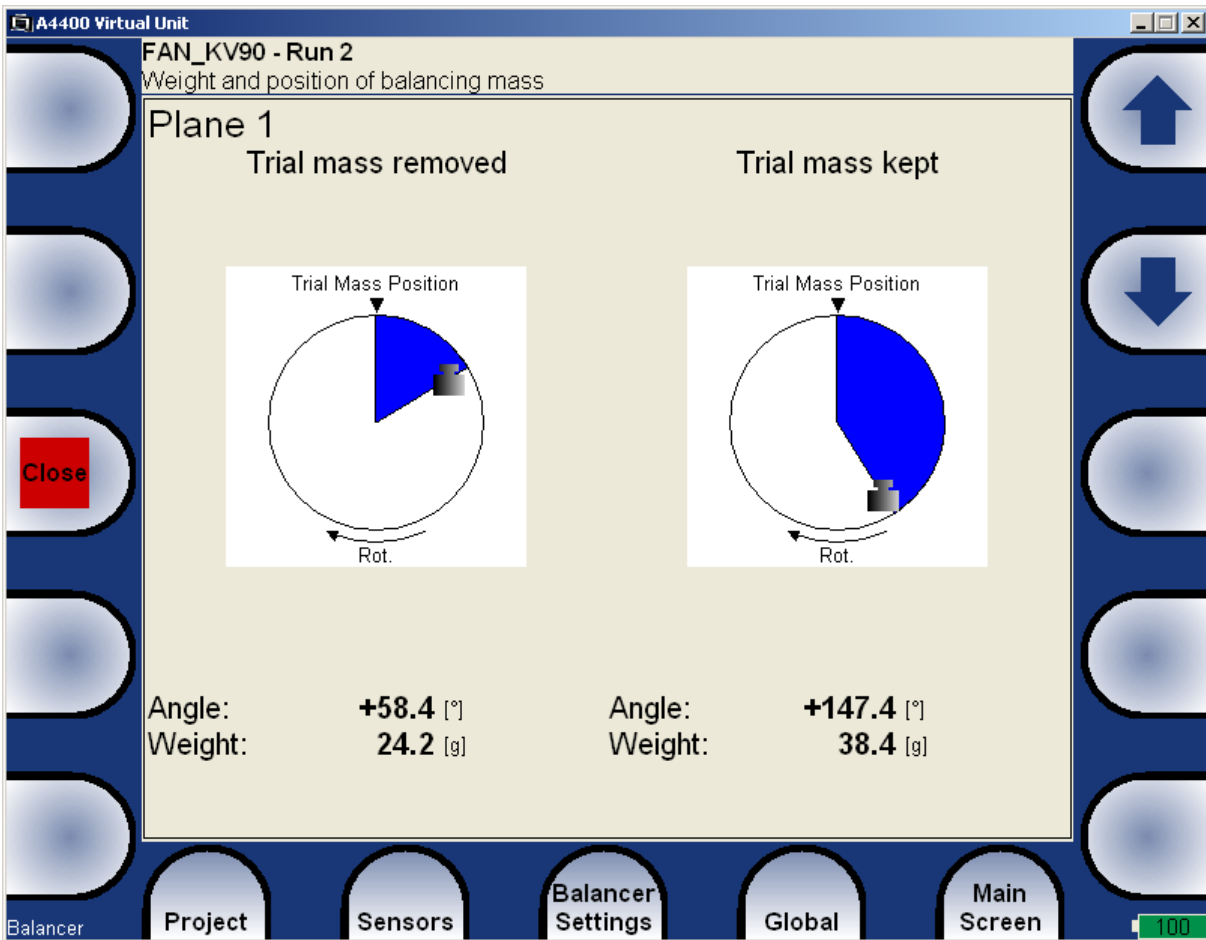

You can continue in two ways. The left side determines the mass, if the trial mass is removed from the rotor. The right side determines the mass, if the trial mass is kept on the rotor.

If the number of blades was defined, the final mass is divided to the nearest blades of the exact balancing angle. The angle position is always measured from position of trial mass.

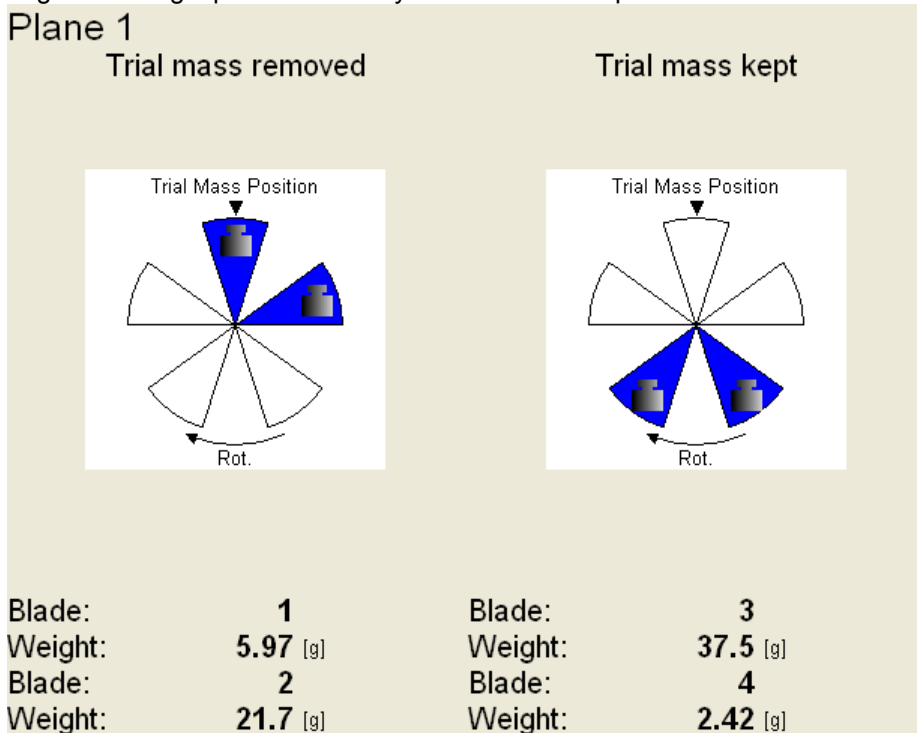

The RUN 3 screen

When the mass or masses are mounted you want to check the job. The screen is very similar to RUN 1 screen. Make the measurement or manually enter the values.

Amplitude:	1.10 [mm/s RMS]
Phase:	+36.0 [°]
Speed:	25.0 [Hz]
Run 1:	12.0 [mm/s RMS]
Effect:	90.8 [%]
Bal.Quality:	1.74

RUN1 amplitude of RUN1

Effect is the reduction of balancing in % (the 1.1mm/s is the 9.2% of 12.5 mm/s according to rounding)

Quality balancing quality factor according ISO 1940 (mass of rotor and radius of balancing required)

Trim Screens

After RUN3 measurement you can continue (press down arrow) with the job when you are not satisfied with the results. These next steps do not required trial mass measurements already. After each measurement the next mass (masses) is recommended. The trim screens are very similar to screens described beyond.

Trim 1

Angle:	+38.4 [°]
Weight:	2.22 [g]

The recommended trim mass is displayed. After the mounting press the down arrow.

The TRIM 1 screen appears. It is the same screen as RUN 3 screen. Run the measurement or enter the values. Then the new results, effect and quality value are displayed.

Amplitude:	0.900 [mm/s RMS]
Phase:	+59.0 [°]
Speed:	25.0 [Hz]
Run 1:	12.0 [mm/s RMS]
Effect:	92.5 [%]
Bal.Quality:	1.55

Press the down arrow and continue with TRIM 2 in same way as with TRIM 1. You can use how many trims you want. But when after trim the result is not better (or even is worse) the next trims has not sense.

Dual plane balancing

RUN 1 screen

The screen is divided to two parts. The left part corresponds to plane 1 and right to plane 2.

If you use only one sensor, then only one part is active. The non-active part is grey and contains un-sharpened image. Mount the sensor to the active plane point and start the measurement. Corresponding bearing house is red colored. The results appear in the bottom. Use the right/left arrow button to move the active focus. Make the same for the second plane.

With two sensors you make both plane measurements together at once.

You can also use the **Edit** button, when you want to enter the values manually. Use the **Tab** for shift between values.

Then the screen should look like next picture.

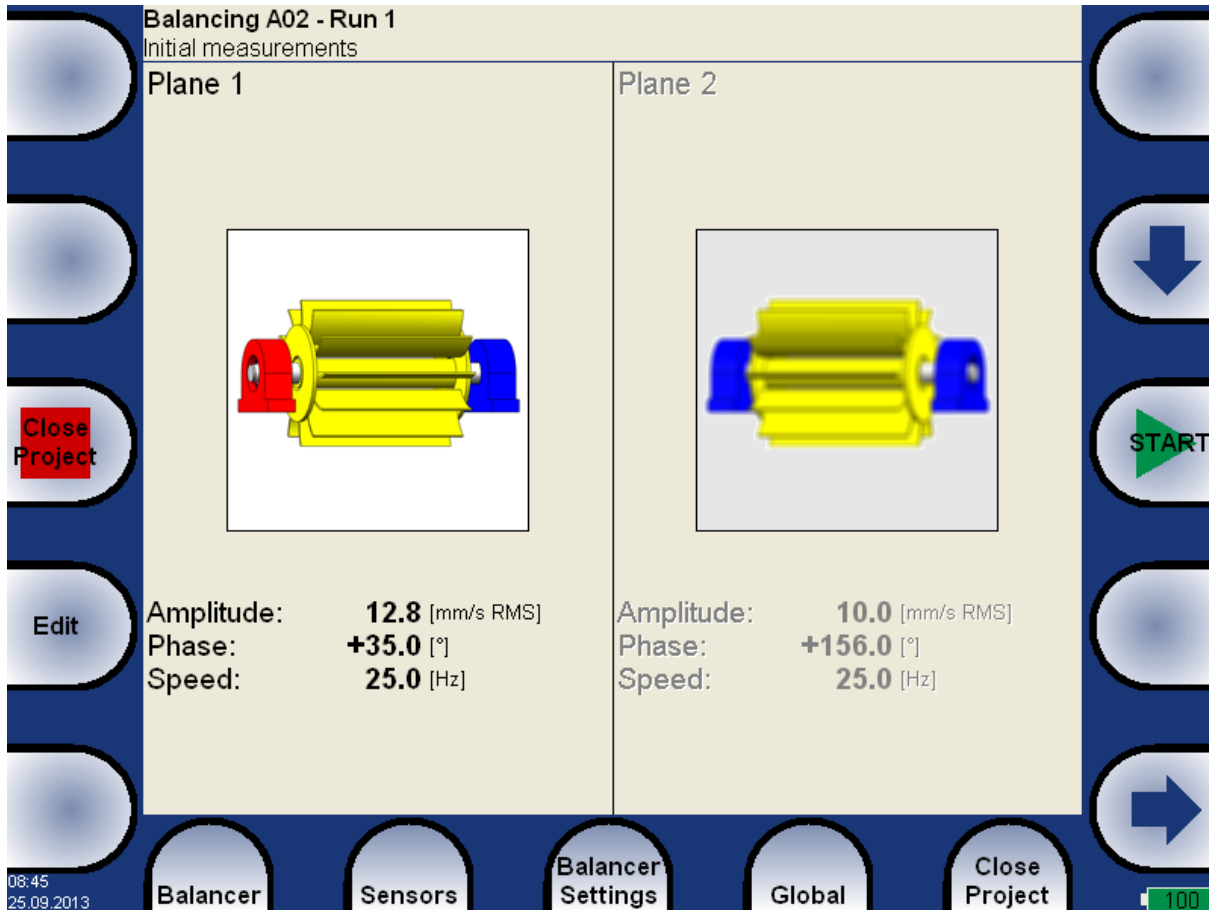

RUN 2 with trial mass in plane 1

It is similar like single plane balancing, only two trial masses must be subsequently mount to two planes. If you know the dynamic factor, then you can enter all 4 values manually and you do not need measure the RUN2.

The red disc on the screen is displayed on the plane, to which should be just mount the trial mass. If you defined the properties in **Rotor Settings**, then the recommended trial mass is displayed.

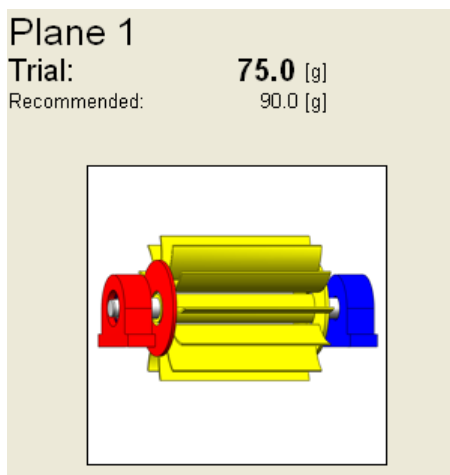

Use the **Enter Trial** button for re-entering of the trial mass, if it is required.

The corresponding plane for trial mass mounting is demonstrated by the red disc. After the measurement of plane 1 take the measurement on plane 2 (or take them at once, when you use 2 channels). The trial mass remain in the plane 1.

After measurements of both planes with trial mass on the plane 1 remove the trial mass from plane 1. The RUN 2 with trial in plane 1 completed screen is in the next picture.

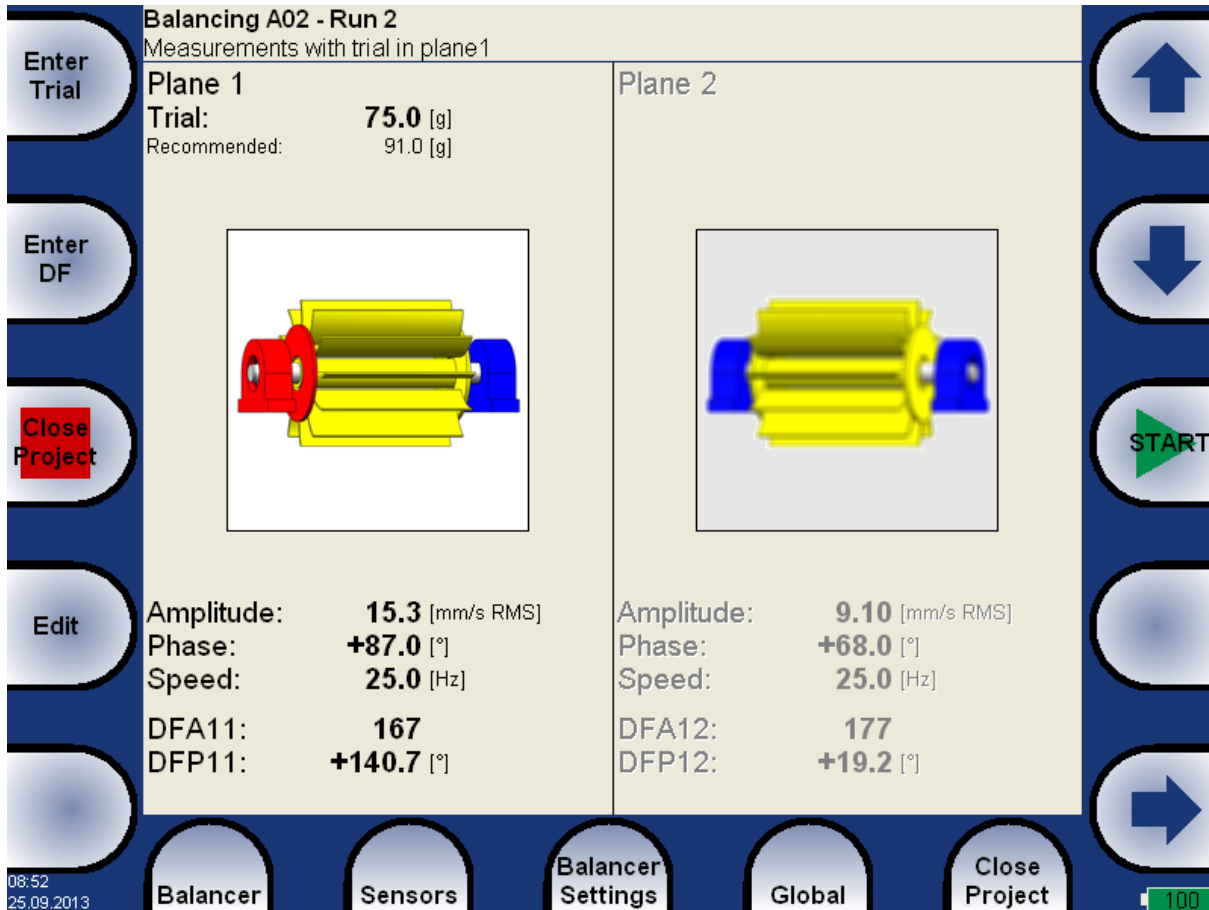

Press **down arrow**.

The trial mass reminder message appears.

Remove trial mass

If you have decided to keep the trial masses option, then the reminder message appears.

Do not remove trial mass

RUN 2 with trial mass in plane 2

The same two measurements we have to take with trial mass on plane 2. The screen for those measurement looks similarly like previous screen. Only the red disc is in the plane 2. Press down arrow button after both measurements.

The RUN 2 completed screen is in the next picture.

Balancing A02 - Run 2
Measurements with trial in plane2

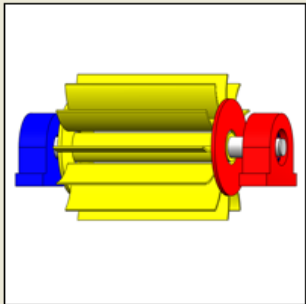
Plane 1	Plane 2
	Trial: 75.0 [g] Recommended: 91.0 [g] 
Amplitude: 4.50 [mm/s RMS] Phase: +156.0 [°] Speed: 25.0 [Hz] DFA21: 208 DFP21: -159.3 [°]	Amplitude: 7.20 [mm/s RMS] Phase: +97.0 [°] Speed: 25.0 [Hz] DFA22: 118 DFP22: +20.4 [°]

08:54
25.09.2013

Balancer Sensors Balancer Settings Global Close Project 100

Press down arrow.

The same reminder message appears as in last run.

RUN 2 - Result screen

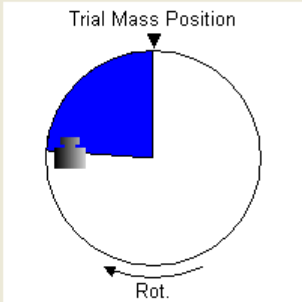
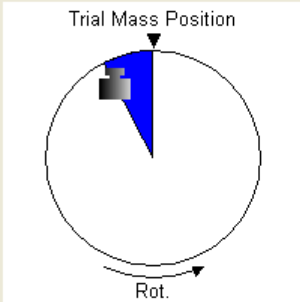
Plane 1	Plane 2
Trial mass kept 	Trial mass kept 
Angle: -85.4 [°] Weight: 33.7 [g]	Angle: +28.1 [°] Weight: 34.1 [g]

Mount the final masses to both planes. The angle is applied from trial mass position, which represents the 0 (zero) degrees.

In case you have used blades, the result screen may look like that.

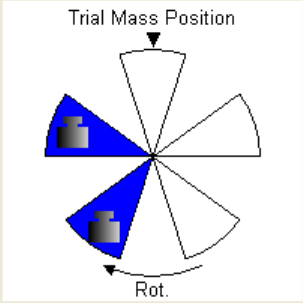
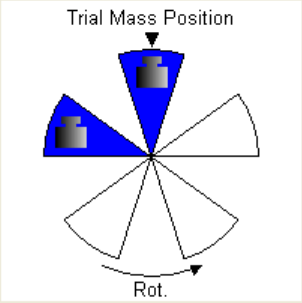
Plane 1		Plane 2	
Trial mass kept		Trial mass kept	
			
Blade:	4	Blade:	1
Weight:	8.18 [g]	Weight:	24.9 [g]
Blade:	5	Blade:	2
Weight:	30.2 [g]	Weight:	16.9 [g]

The RUN 3 screen

When the masses are mounted then you want to check the job. The measurements on both planes are required.

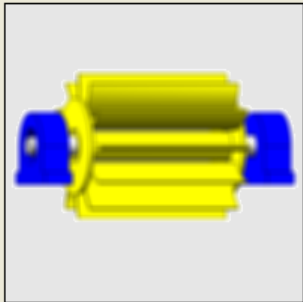
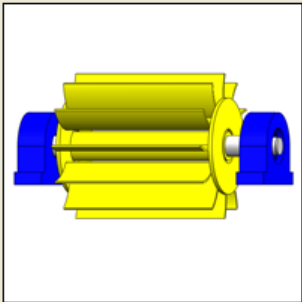
Plane 1		Plane 2	
			
Amplitude:	3.50 [mm/s RMS]	Amplitude:	4.30 [mm/s RMS]
Phase:	+24.0 [°]	Phase:	+65.0 [°]
Speed:	25.0 [Hz]	Speed:	25.0 [Hz]
Run 1:	12.8 [mm/s RMS]	Run 1:	10.6 [mm/s RMS]
Effect:	72.7 [%]	Effect:	59.4 [%]
Bal. Quality:	8.13	Bal. Quality:	15.2

The screen is in fact the same as screen for RUN 1 with additional information.

RUN1 original amplitude of RUN1

Effect is the reduction of vibrations in %

Quality balancing quality factor according ISO 1940 (mass of rotor and radius of balancing required)

Trim Screens

After RUN3 measurement you can continue with the job when you are not satisfied with the results. These next steps do not require trial mass measurements already. After each measurement the next masses are recommended. The trim screens are very similar to screens in single plane balancing.

Balancing Errors

Balancing errors and warnings can occur during the job.

The effect of trial weight is low

This message informs you that the effect of the trial mass is low.

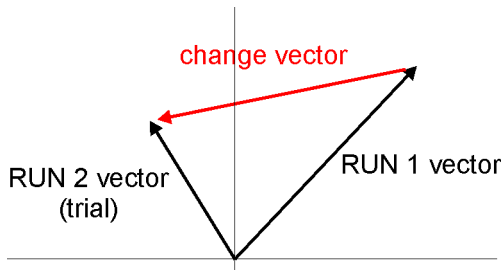

The percentual value is derived from ratio (amplitude of change vector/ amplitude of RUN1 vector).

The percentage value is derived from the ratio (amplitude of vector change/ amplitude of RUN 1 vector).

A warning is displayed when the change is less than 20% but bigger than 1%. You can continue with balancing after this warning and use these values.

An error is displayed when the change is less than 1%. You cannot continue with balancing after this error, because such a small change is not acceptable. You could get incorrect results.

The RunUp

Measurement Control

When you need to measure Run Up or Coast Down of the machines, then you should use the RunUp mode. It enables the same measurements as in Analyzer mode, but controlled by speed, time or uncontrolled.

What does it mean "controlled"? In Analyzer mode you can measure the Set and then you have to save measurements manually.

The RunUp is different. The measurements are saved automatically and additionally the measurements are regularly repeated under the control. The trigger function is used for that control. The menu item **Global/ Trigger Settings/ RunUp mode** is used for setting.

Usually the **speed** is used for that control and new measurement is made, when the speed changes from previous measurement of defined value (e.g.10 RPM).

Also the **time** can be used to control that procedure. Then you can take the measurement in defined time interval (e.g. each 60 sec).

The **asap** is the next choice. It means no delay between measurements - **As Soon As Possible**. Be careful for such mode. You can use all memory quickly.

The last choice is the **Manual** mode. You can press the **Start** button at any suitable moment to make a new measurement.

The ending of run up is usually made manually by pushing **STOP** button.

The information about used and free memory is displayed **during** the measurement (e.g. 5 / 103.2GB).

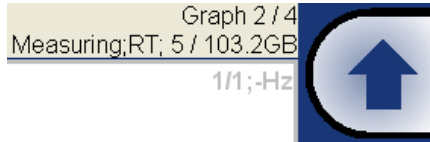

The Set and other items

The meaning of the **Set** and also meaning of other items in the RunUp menu are the same as in the Analyzer mode.

Run up measurement

For example we define only one measurement in set. The proximity sensor on channel 1 is used.

Type:	aps freerun,asap
Channel:	1
Unit:	µm
Averaging:	linear
Avg:	off
Resolution:	speed / 4
	Save

The RunUp mode is set to **speed** and the value is 1Hz.

Start measurement - push **Start** button. After the full speed is achieved press **STOP**.

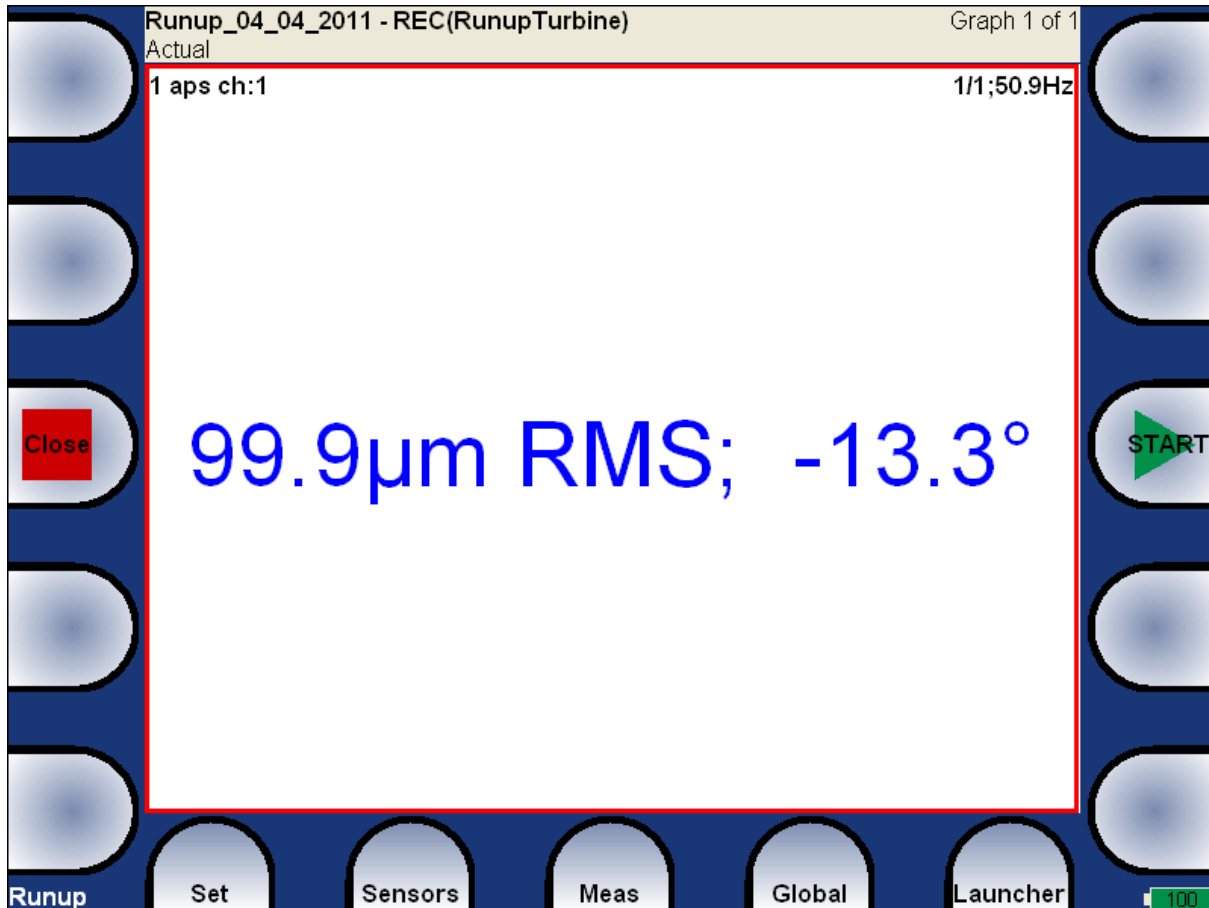

The last measured value is on the screen.

Press **Set/ View Trend** and in the left upper screen corner the list of measured run ups appear. Every new measurement creates new item in this list. The date and time of measurement is displayed. Select one trend from the list and press **OK**.

If the analyze is made from record, then two time stamps are displayed. The analyze time is the first and the measurement time is the second.

One runup measurement can be divided into more files (e.g. runup is very long). See the Global/Runup chapter.

2014/01/24 09:56:21
2014/01/24 10:01:05
2014/01/24 10:04:45 (2010/04/17 02:24:10)
2014/01/24 10:05:13 (2010/04/17 02:39:00)
2014/01/24 10:05:42 (2010/04/17 02:54:00)

Menu Trend

When the list of trends is displayed, then the Menu Trend button is available. It contains next functions:

Delete deletes selected trends

Export exports selected trends

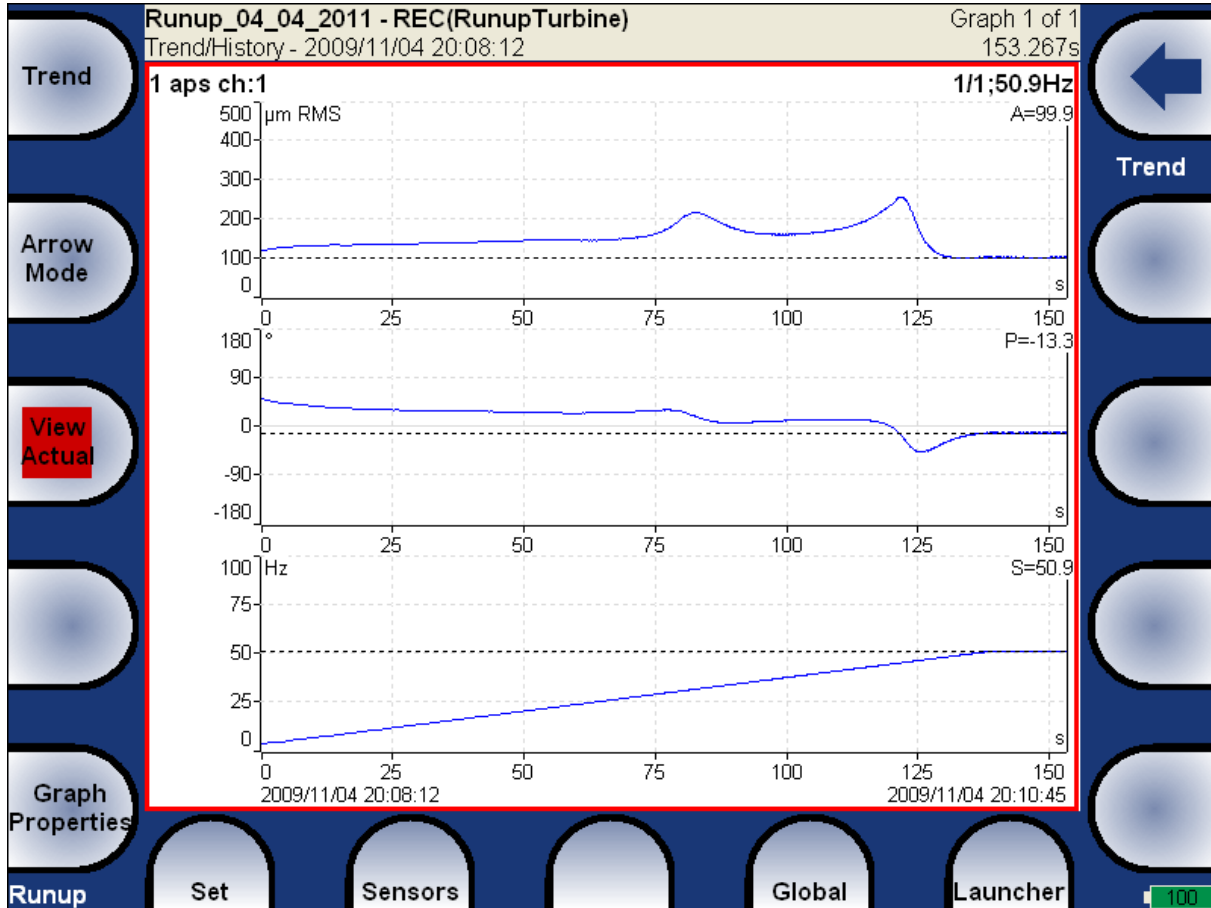

The aps - amplitude+phase+speed graphs appear. Several types of graphs is available under the **View** item. All items are in details described in chapter

The Analyzer Mode/The Analyzer buttons description/Graph Properties.

Use **Arrow Mode** button for functions selection.

The Route

Loading of the route to the instrument

The co-operation with DDS2014 software is required for the route measurement. See also the DDS user manual for more details. We do not describe all details about DDS2014 function in this guide.

Open the database in DDS2014, from which you want create the route. Use menu Route / A4400-VA4Pro.

Connect the unit with the computer. See **Connection to the computer** chapter.

Press the **Connect** button and DDS2014 will automatically connect and receive projects (Off-route, Runup, Route...) from VA4Pro.

There are two options - move required points directly from DDS2014 tree to the projects list or from predefined list of routes (use mouse Drag'n'Drop).

You can see that the structure of tree is changed. This is because in VA4Pro strictly requires the tree with the following structure Tree_Name - Machine - Measuring Point - Data Cell. If there are more items in DDS tree in a path between this items, the names of such items are combined together (like in this example "Turbo Generator/Fans/Fan 1" or "Motor/L1RV" etc.). If the item name in a route tree is longer then 45 characters DDS is trying to truncate such names. To avoid this we recommend to use shortcuts in a tree items (in this case "Turbo Generator" should be "TG").

Select route(s) in projects windows and press "Send" button in instrument window.

Creation of the route tree

The route tree can be created also in the VA4 directly. The new database must be created in DDS for it. See DDS guide for details.

Route measurement

In VA4Pro select the **Route** mode in main screen. The list of routes in the memory is displayed. The time and date of last saving of selected project is displayed in top right corner.

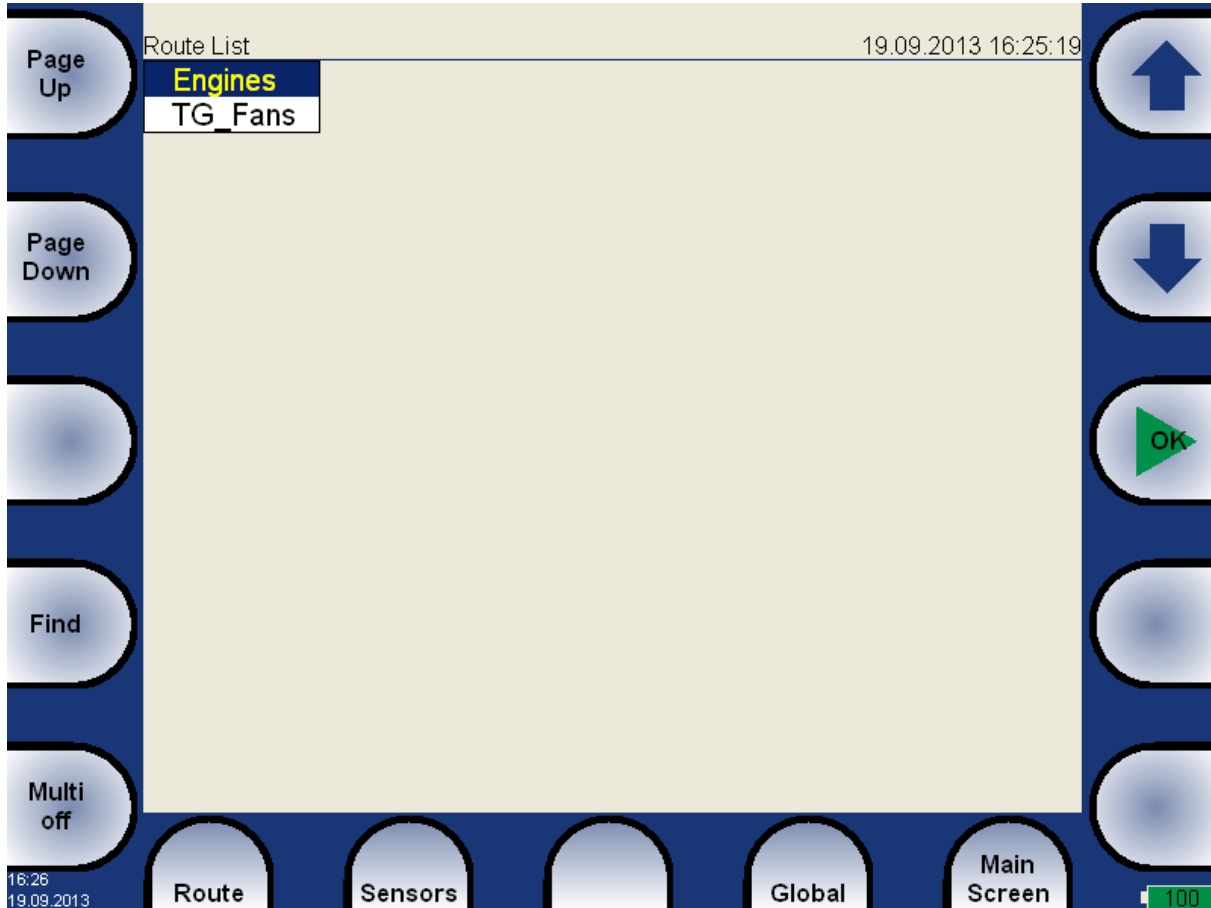

Select one route and press OK. The list of machines appears.

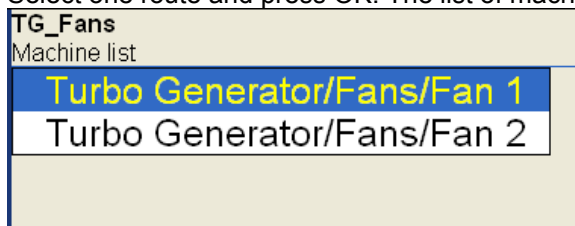

Select the machine and press right arrow to develop the list of measurement points. The number of AC channels for each point is displayed behind the point name.

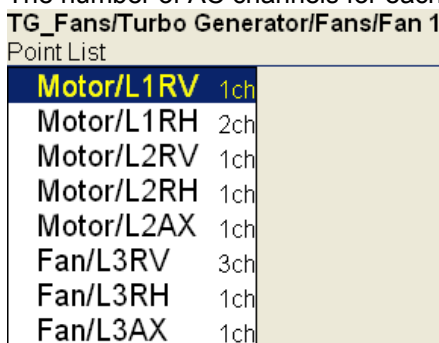

In this moment you can start the measurement or by right arrow display the list of measurements, which are defined for this point. The channel number is displayed in front of name of measurement. By left arrow button you will close the displayed list and you return back to the previous level.



When you press the **Start** button in the points list, the measurement graphs are drawn with the **No_Data** message. If the required sensor (defined in the route) is not compatible with the sensor connected to channel input (Sensors properties) instrument warns us about this. In this case change the sensor or use the different sensitivity and press **Continue**.

Press the **START** to begin the point measurement. All defined measurement will be taken together.

The complete point measurement should be taken now. The measured data are or are not displayed on the screen regarding the **Display Route Values** parameter in **Global Settings**.

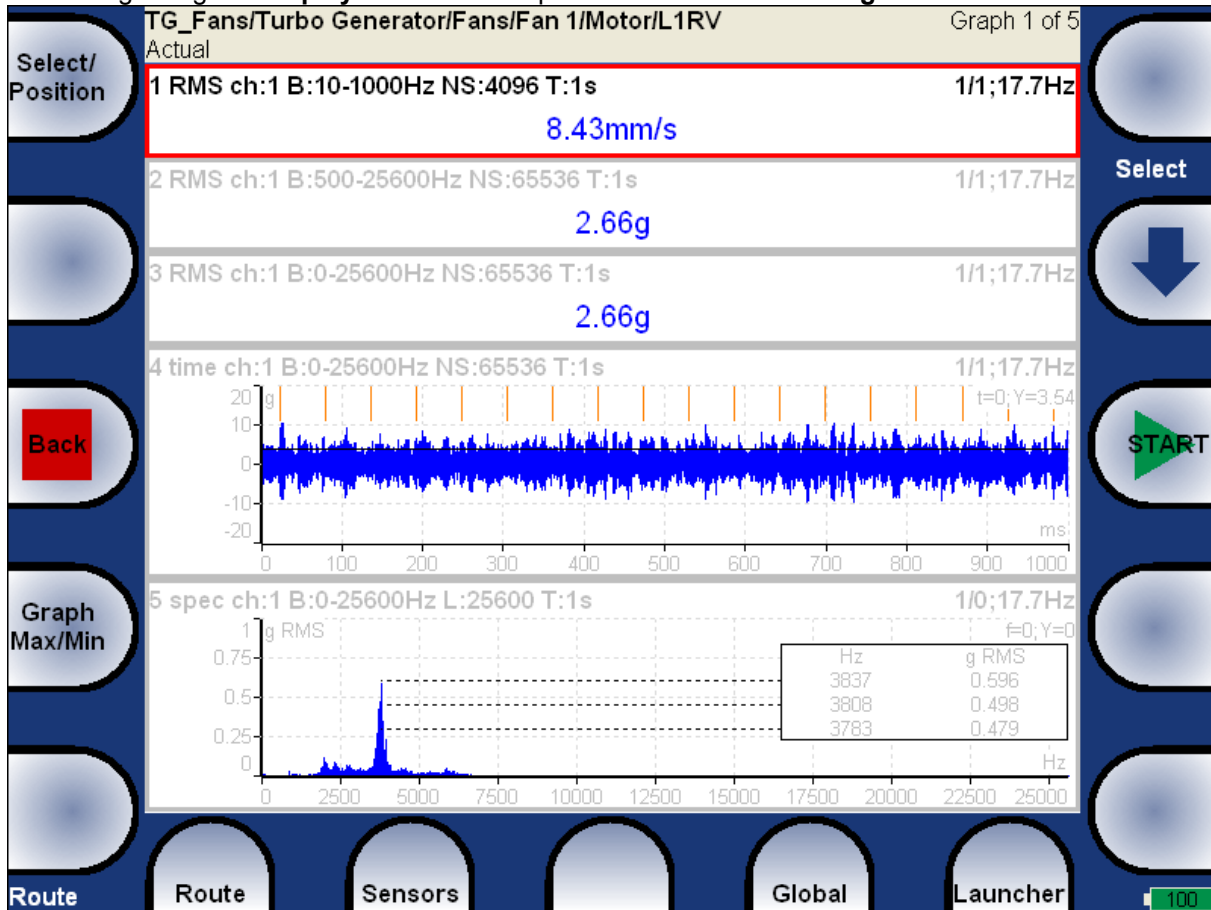

Use the Back to return back to points list. The measured point is labeled by the symbol $\sqrt{\quad}$ (all defined measurement were taken) or by the cross (some measurements were not taken due to error).

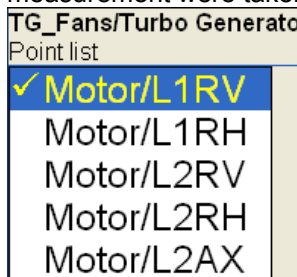

Reference values

You can download reference values from DDS to VA4Pro unit for spectrum and overall measurements. These values are displayed together with measured values.

Reference spectrum is displayed together with measured spectrum in the same graph.

Overall reference value is displayed in left side of graph and it is signed by "R:" or like a line in trend view.

1 RMS ch:1 B:10-1000Hz NS:4096 T:1s 1/1;-Hz
 R: 3.39 mm/s 1.07 mm/s

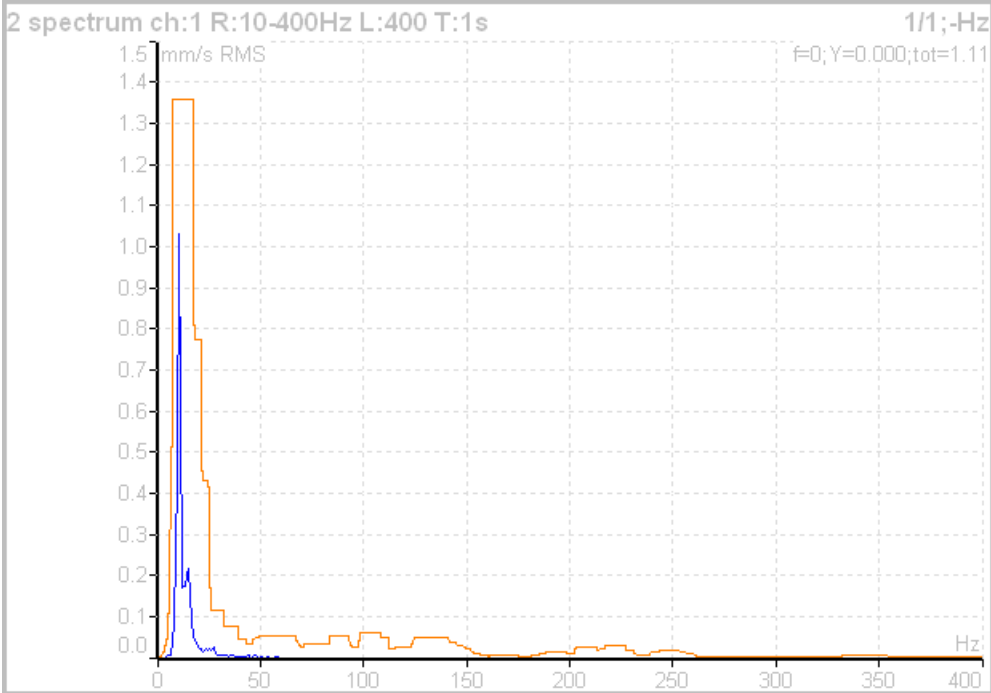

Manual entry

The route may contain the measurements, which have to be entered manually (e.g. temperatures read from analogue display). The measurement with subtype **MANUAL** in DDS is defined. Before beginning of measurements from sensors (after you press START button) the window for manual input appears (one for each manual input).

Enter value [°C]
 Temp (Graph1)

Notes

You can attach the short text notes to route points.

There are three ways how handle with notes.

1. Enter the note manually.
2. Select predefined note from **Factory notes** set.
3. Select predefined note from **User notes**. This set is created and edited by user.

Press the button on the left bottom (it can have more names as **Route**, **Machine** or **Point**). Select **Notes** item. The list of existed notes for selected point appears. It is empty when no note was created yet.

Notes
 Point_B

Empty

New note

Press **Add** button to create new note. New window appears. In the upper half area you can directly type the note. The User notes list is displayed in the bottom. The several ways how to create new note exist.

- Select one note from User notes list and press **Select**. Selected note is copied to the upper area.
- Press **User/Factory** button to change the User notes to Factory notes or back. Then select the note and press **Select**.

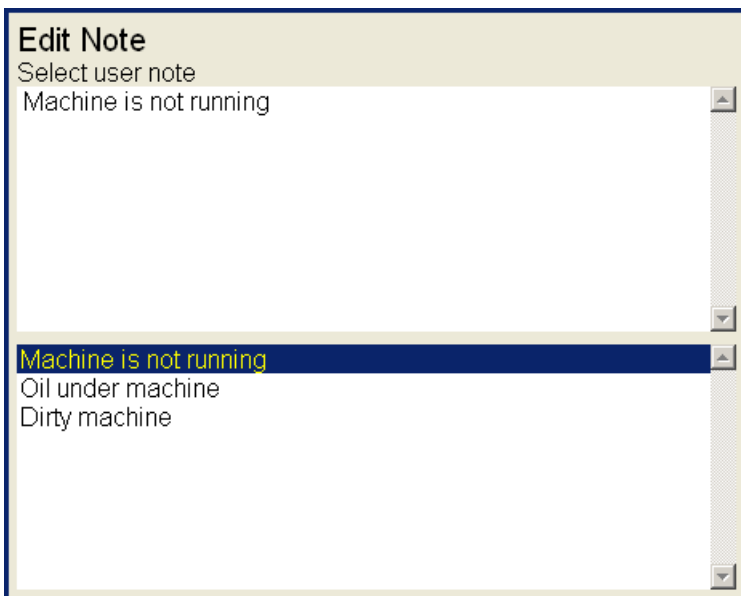
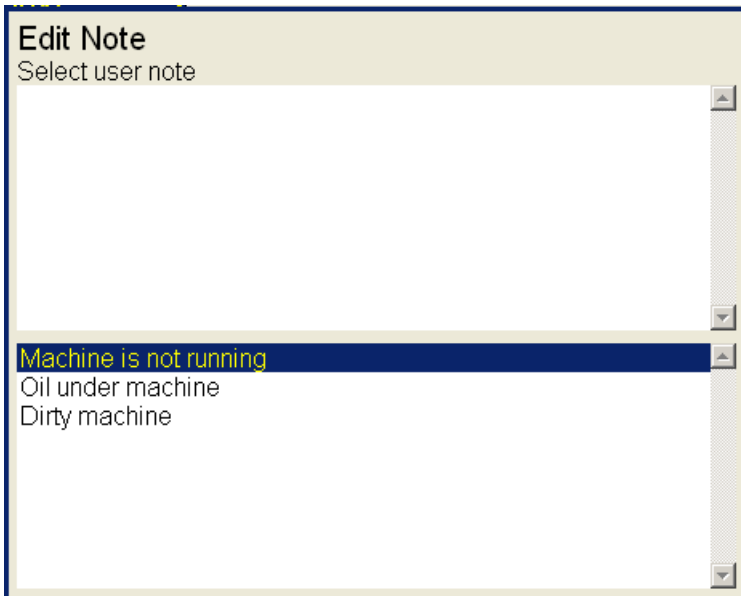

- If you want to enter your own text, then press **Edit Text** button. The cursor appears in upper area and you can enter the required note. Press **Notes List** (the same button position as **Edit Text**) to return back to the selection of User/Factory note.

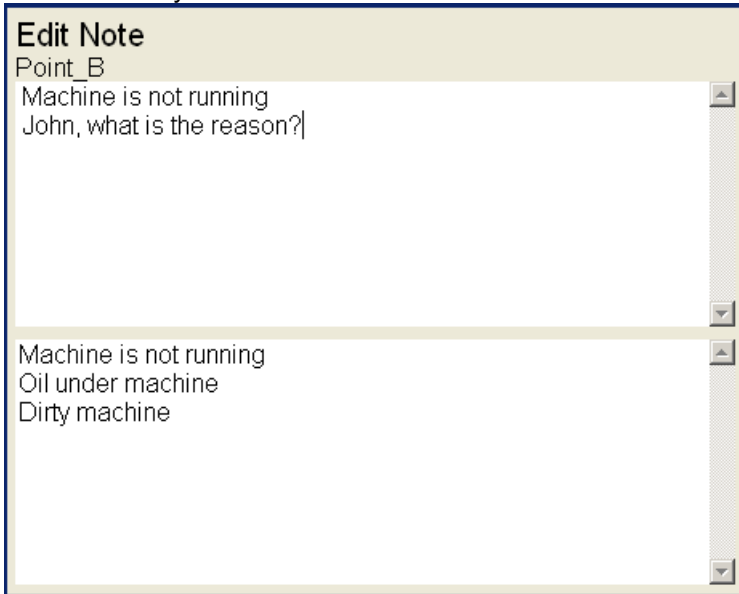

If the note is done, press **Save** button. You return back to the list of all notes for selected point.

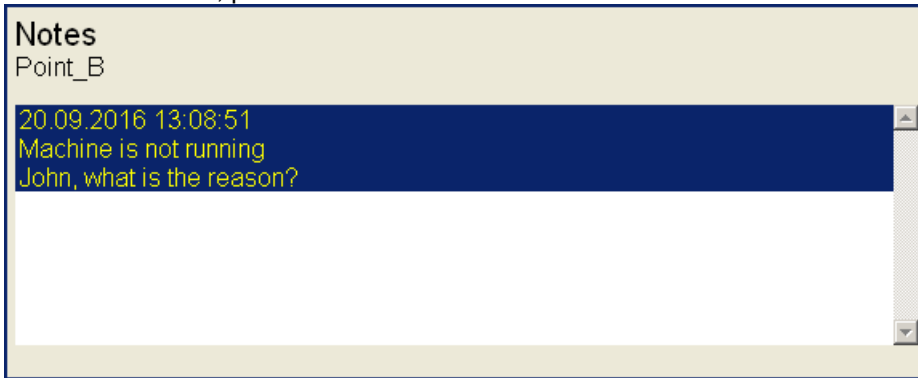

Press **OK** to leave the list of notes. The **N** letter appears behind the point name.

Note edit

Select the note from the list and press **Edit** button. Then use the same procedures as for new note for editing.

To delete the selected note press **Delete**.

Press **OK** to leave the list of notes. The **N** letter appears behind the point name.

Export to VA4_DISC

The computer can read any data from VA4_DISC only. The route with measured data has to be exported to this memory before the transfer. During the route measurement are data saved to the VA4 hard disc only. When the route is closed the VA4 asks the user "Export to VA4_DISC?" and user selects one option. The export to VA4_DISC is not done automatically because the writing procedure to flash is slow. The large route export can take several minutes. That is why the user can determine, when the right moment to export the route is. In the menu item **Route/ Export** you can select the route and export it manually.

Download of the route to the computer

The process is the same as the load of route to the instrument. In **VA4Pro instrument window** use the **Receive** button and select the required route from the list (all routes saved in the VA4_DISC). The list of all

points appears in instrument window. The grey items were not measured. Press **Store to database** to save data.

Speed in the route

There are various ways how to get the speed and transfer it to DDS. The ways are described here in the order from the lowest priority to the highest priority.

Speed entered in the VA4

The speed can be entered manually with the function Enter Speed (described before).

Speed entered in DDS

The **Default Speed** can be set up on DDS as the tree item parameter. **Default Speed** can be entered as a value or as a **Variable Speed**. The **Variable Speed** is detected before the measurement itself (see the **Speed Detection** chapter). Detected speed is valid for whole machine. Unless you close the machine item, the same speed value is valid and no other detection takes place. Speed entered in DDS has always priority before the speed entered in the device.

Measured Speed

If the speed is measured by tacho probe, it is saved always with data regardless the fact if there were already defined by one of the previous ways (speed entered in device or DDS).

Current entered or detected speed value (if defined) is displayed in information panel at the right (if the measurement is not in progress).

Speed: 50.8 Hz

The Recorder

Many of older engineers remember the past time, when the signal was recorded to the tape-recorder and consequently analyzed in Analyzer. Such approach had one important benefit. You can analyze the signal again and again. When you need to make all required analysis in real-time, you are under time pressure. If additionally the e.g. runup can be run only once, the pressure is extreme. The tape-recorder was the solution. It was simple unit with simple operation, no danger to loose the data.

The same solution offers the VA4 Recorder. It enables to record simultaneously all 4 AC channels, tacho channel and 4 DC process values channels into the unit memory. The sampling frequency is from 64Hz to 196kHz. The maximum record length depends of free memory size, which is displayed in right upper corner.

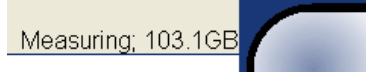

New Record

Run the Recorder. The list of records which are saved already in the memory appears on the screen. Push the **Project/ New** button and enter the name. The new item appears in the list. Select it and push **OK**.

Sampling Frequency[Hz]: 65536	
Range=25600Hz	
AC1:	on
AC2:	off
AC3:	off
AC4:	off
DC1:	off
DC2:	off
DC3:	off
DC4:	off
Trigger Channel:	on
Time[minutes]:	manually stopped
Start of Rec:	freerun
Save	

Select the **Sampling Frequency**. Switch to **on** all channels you want to record. Define the length of record (or how it will be stopped). Select the **Start of Rec** way.

Start of Rec

freerun After the measurement preparation is the recording started immediately.

external The **external** signal (voltage level higher then defined threshold level in the **Global** menu) starts the recording. Such signal may be generated e.g. when the machine starts to work. This type of signal is usually created in the control system.

amplitude The recording is started when the signal level exceed the **Threshold level**, which is set by user in **Global** menu. Both - positive and negative levels are accepted.

When the **Record** parameters are set, use the **Start** button for start of the recording. During the recording all recorded input signals are displayed on the screen.

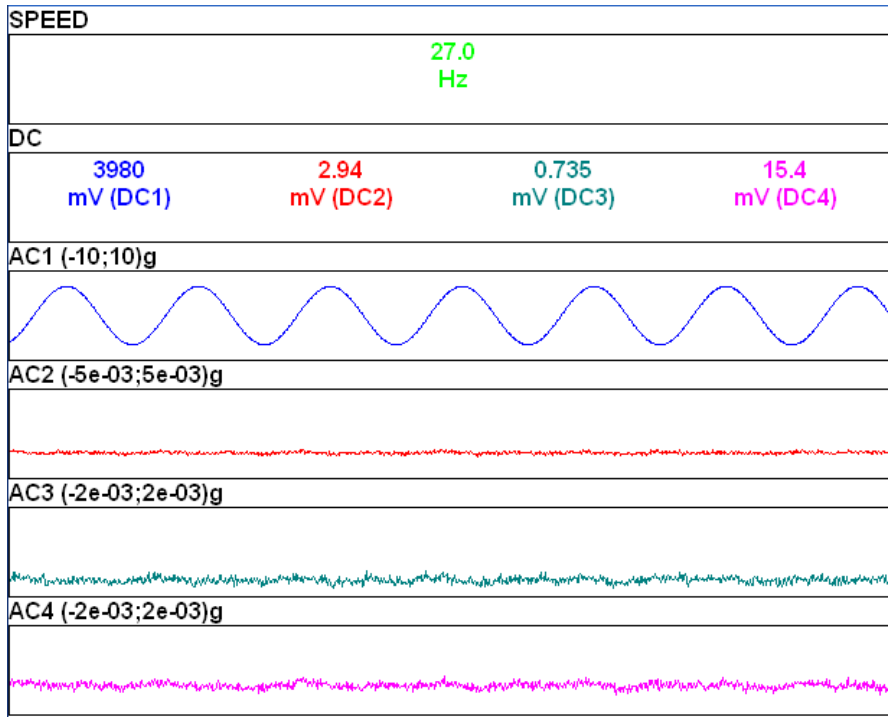

The process is finished when

- the time is over,
- manually by Stop button,
- the memory is full.

Editing of Record

Run the Recorder. The list of records which are saved already in the memory appears on the screen. The time and date of last saving of selected record is displayed in top right corner. Select one of them (arrows and OK). The preview of recorded signals appears.

Project button

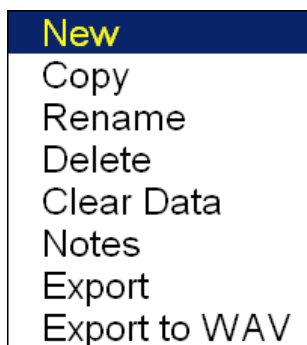

- New** the new project for recording
- Copy** copies all record parameters to new project without the recorded data
- Rename** renames the project
- Delete** deletes project from memory
- Clear Data** deletes recorded data, all record parameters is kept
- Notes** adds the notice to the record, see **Global Properties/ User Notes** chapter
- Export** exports the record to **VA4_DISC**
- Export to wav** exports the record to wav data format (all channels are saved to one multichannel wav file, for example the Audacity software can read it))
- Export to wav Settings** setting of next export parameters (see next chapter)

Export to wav Settings

Contains setting of advanced parameters.

AC1:	0
AC2:	0
AC3:	0
AC4:	0
Mixer:	off
Range [V]:	max
Save	

AC1 – AC4 all channels can be mixed to one channel into wav file (like in music studio). The gain factor can be defined for each channel. When the zero is used, then this channel will not be used for mixing.

Mixer on, off Select **on** when you want mix all channels to one channel wav file. If the **off** is used, then multichannel wav file will be created. The gain factors are used in both options.

Range [V] 1.5, max, auto, user

The full AC range of VA4 Pro is +/- 12V. This range is also used for wav export. But it is usually too much, because the real voltage level is much lower. For example the range hundreds of millivolts measured from accelerometer 100mV/g. The wav file is then very quiet. The **Range** option enables to apply better wav range and better hearing from headphones.

1.5 this range should be generally acceptable in most of cases

max the 12V is used as range

auto the reached maximum value in signal is used as range

user any value from (0.1 - 12) interval

If you need to compare two signals in headphones (for example the noise of old and new bearing) then the same range must be used.

When the range value is lower then the range of signal, then the warning **Wav overload** appears.

Sensors button

You can change the sensor parameters for next recording.

Record button

The record parameters are displayed. You can change them, but it will influence the next record.

START button

It starts new recording. The old recorded data will be rewritten.

Properties button

It displays all record properties.

Cursor and Length arrow buttons

When the record contains longer data then you need to analyzing you can select any part of record and save it as new record.

The **Cursor** arrow defines the beginning of new record. The **Length** defines the length of new record. when you defined the borders of new record, use the **Save Selection As** button.

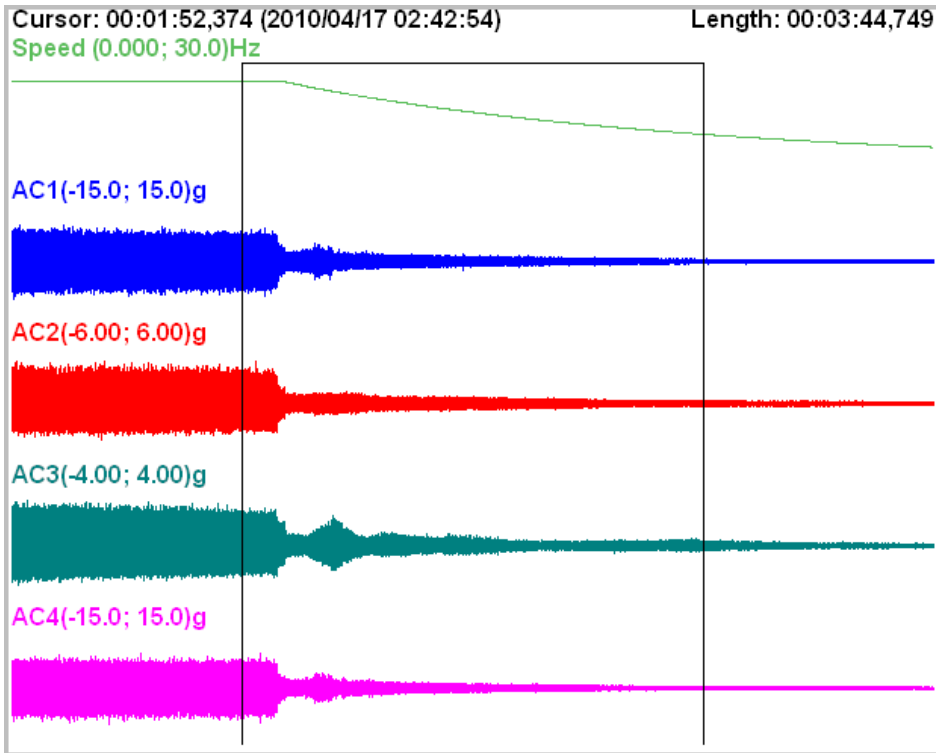

Arrow mode

It changes the arrows from **Cursor+Length** to **ZoomX+Y**.

Zoom X button

It switches the display between complete record and the zoom selection made by **Cursor+Length**.

Zoom Y button

It is standard Y zooming.

Using of record for analyzing

When you select the record for analyzing in any VA4 module, then the preview appears on the top of display.

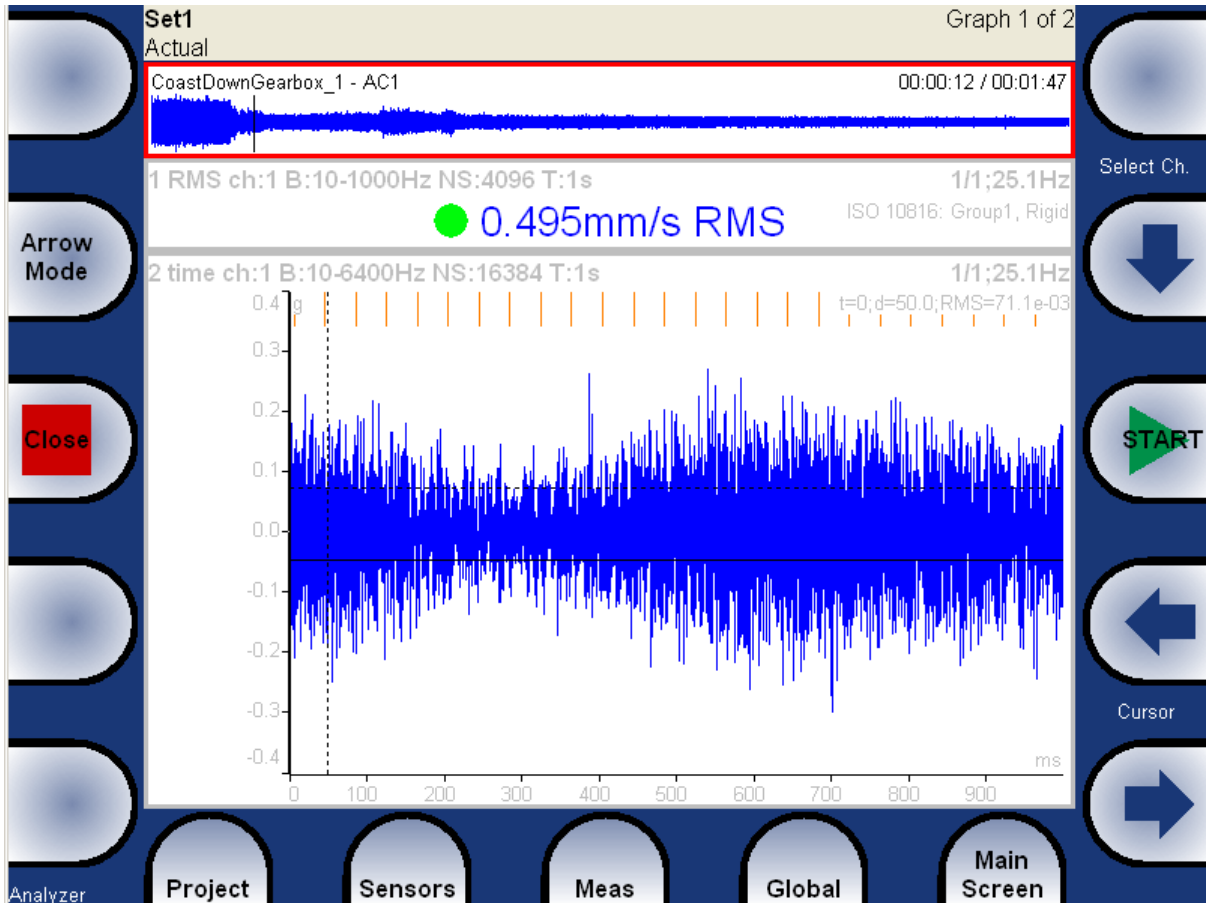

During the analyzing of record the cursor is displayed in the record preview. The moving of cursor is available and it enables to select the required position for analyses.

When you need to move the cursor then you have to select the record area (to move the red border to the record). There are two ways how to do it:

Analyzer, Route and RunUp modes - use the **Arrow Mode** button repetitively until the red border is on the record.

The rest of the modules - use the **Record** button to select and de-select the record.

Also the selection of record channel is available for preview (the record can contain more channels then one). Also the DC channels or speed channel can be used for navigation. When the record is selected, use the **Select Ch.** arrows in the right top of display. Sound of selected channel is also on audio output.

The FASIT

The FASIT means the **FA**ult **S**ource **I**dentification **T**ool. This mode should help beginners to determine the machine condition.

Attention !

The FASIT correctly analyses only machines with speed over 10Hz (600 RPM). The velocity measurements is in the 10-1000Hz range.

Set-up

Select the FASIT mode. The menu appears.



Channel:

The number of the input channel

The menu can be repeatedly opened by pressing **FASIT Settings** button.

Sensor Settings

In the **Sensors** item set up the parameters of the chosen sensor. FASIT uses the measurement of acceleration or velocity from one channel. If you will use a velocity sensor, the bearing condition is not detected. For bearing condition detection the acceleration measurement is necessary.

Units

The displayed units can be set up under the **Global/Global Settings**. Set up the unit of speed (Hz, RPM, CPS, CPM) in the **Speed Unit** item. The vibration values are displayed according to the setting of **Units (metric, imperial)**.

The units are set up as follows:

metric:

acceleration - g
velocity - mm/s

imperial:





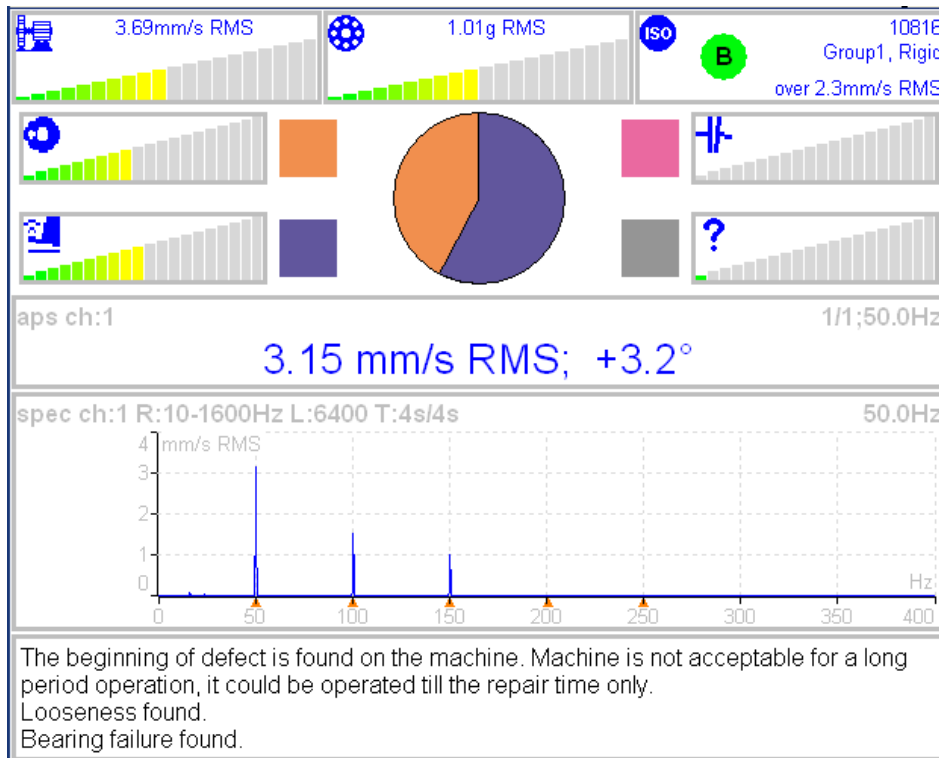

acceleration - g,
velocity – in/s

Measurement

Press the Start button to start the measurement. The speed needs to be known for the processing of this measurement. The speed detection is described in the **Speed Detection** chapter.

FASIT screen

Each horizontal bar displays the severity of individual item. It starts from green color on the left to the red on the right.

-  The machine condition bar, see the Machine limits description below.
-  The bearing condition bar, see the Bearings limits description below.
-  The Unbalance severity level.
-  The Looseness severity level.
-  The Misalignment severity level,
-  The severity level of a different type of a fault.
-  ISO 10816 limits (see the ISO overall measurements), the color of circle is related to the machine condition class A,B,C,D (the green for A or B, the orange for C and the red for D). Also the information about machine group and foundation are displayed. The limit which is exceeding is also displayed at the bottom.

The pie chart displays the percentages of severity of individual faults. The colours in pie chart correspond to the colours of the rectangle next to the individual graphs.

The 1x amp+phase value and velocity spectrum with speed and harmonics (marked by red triangles) are displayed in the middle of screen.

Note: the 1x amp+phase value is displayed only when the speed is measured by a tachometer.

The condition report and advises are in the bottom.

Vibration Limits

Because there are a lot of different types of machines it is impossible to determine the critical limits of vibrations for wide range of machines. Its reliability would be low then. It could happen, you will repair machine, which do not require it. The standards should be rather determined for a narrow range of machines.

The instrument uses the Adash limit values. These limits are not rewritten from any existing standard. It's a result of 20 years of Adash engineering team experiences. It's difficult to invent critical value definition which would be simple (that means not many parameters such as speed, power, bearing type, machine type and so on) and reliable.

On the figures below is clear how we derived limit values. Three levels of machine condition are defined: GOOD, ALERT (Machines lays in this range are not acceptable for a long period operation, they could be operated till time when could be repaired) and DANGER (Vibration values in this range are considered as very dangerous and they can cause a damage of the machine). The corresponding colors are taken from traffic semaphore - green, amber and red.

All limit values are related to the speed value. The low speed machine should generate lower vibration then higher speed machine.

In the graphs area you found three particular areas. The GOOD condition is the space up to the yellow line that means operation without restriction. The space above yellow but under red line is an ALERT condition. Possible to operate the machine but have to be more checked. It's necessary to determine the source of worse condition and plan repair (for instance change the bearing) or maintenance (balancing, alignment). The space above red line is an DANGER condition and the machine should not be operated.

First figure contains the values for overall machine condition and you search unbalance, misalignment, and mechanical looseness above all. They are called "overall" because we can measure them on most of the measuring points. Second figure contains the limit values of a roller bearing condition. This condition is local and can be measured only on appropriate bearing house.

Work with figures is simple. It's necessary to know the speed. Instrument determines it automatically or user can enter it manually. On the bottom horizontal axis you should find the point which corresponds with speed. Above this point you will find an intersection with orange and red graph. Projections to the vertical axis will determine limit values for amber or red state. If the measured value is lower than amber the condition is GOOD – green. If the value is above amber but under red then the condition is ALERT – amber. If the value is higher then red graph then the condition is DANGER – red.

Machine limits

The machine limits are used for velocity RMS value in 10-1000Hz frequency range. This value helps to define the complete health of machine.

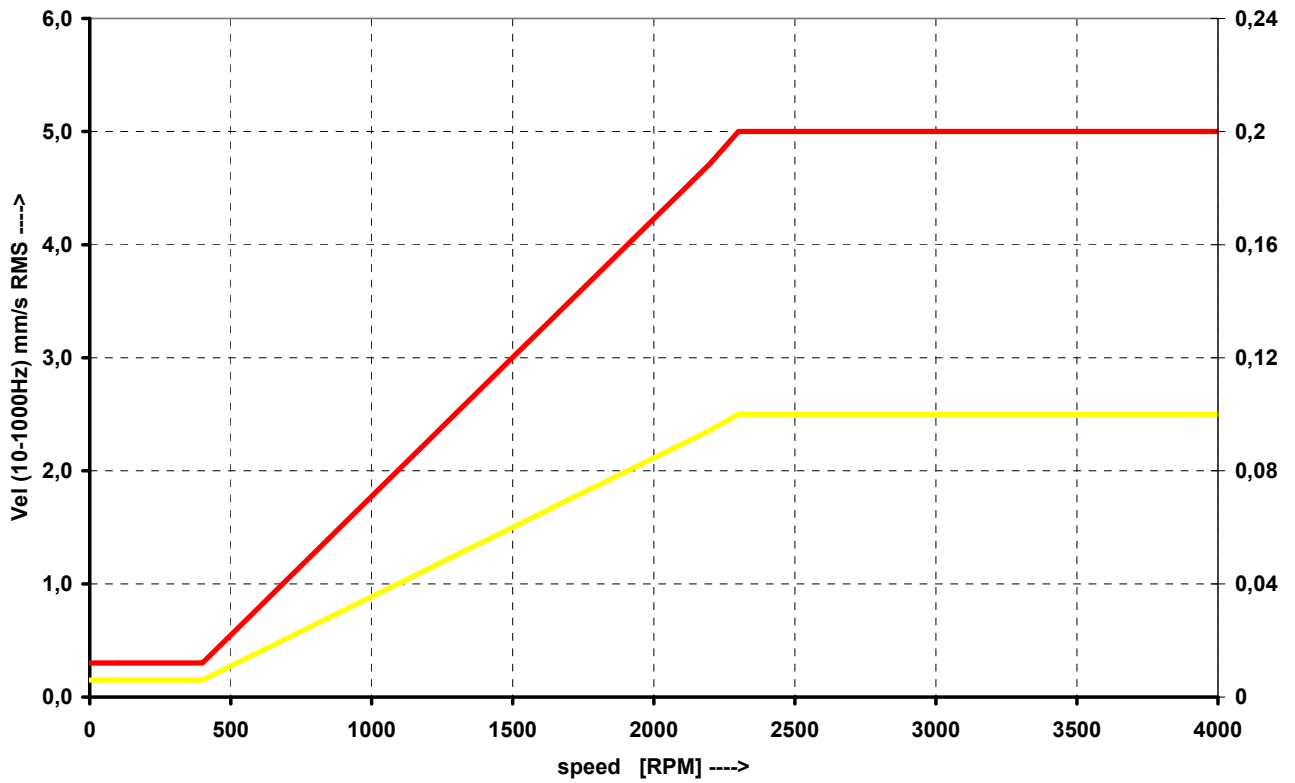

Bearing Limits

The roller bearing limits are used for acceleration RMS value in 500-25600Hz frequency range.

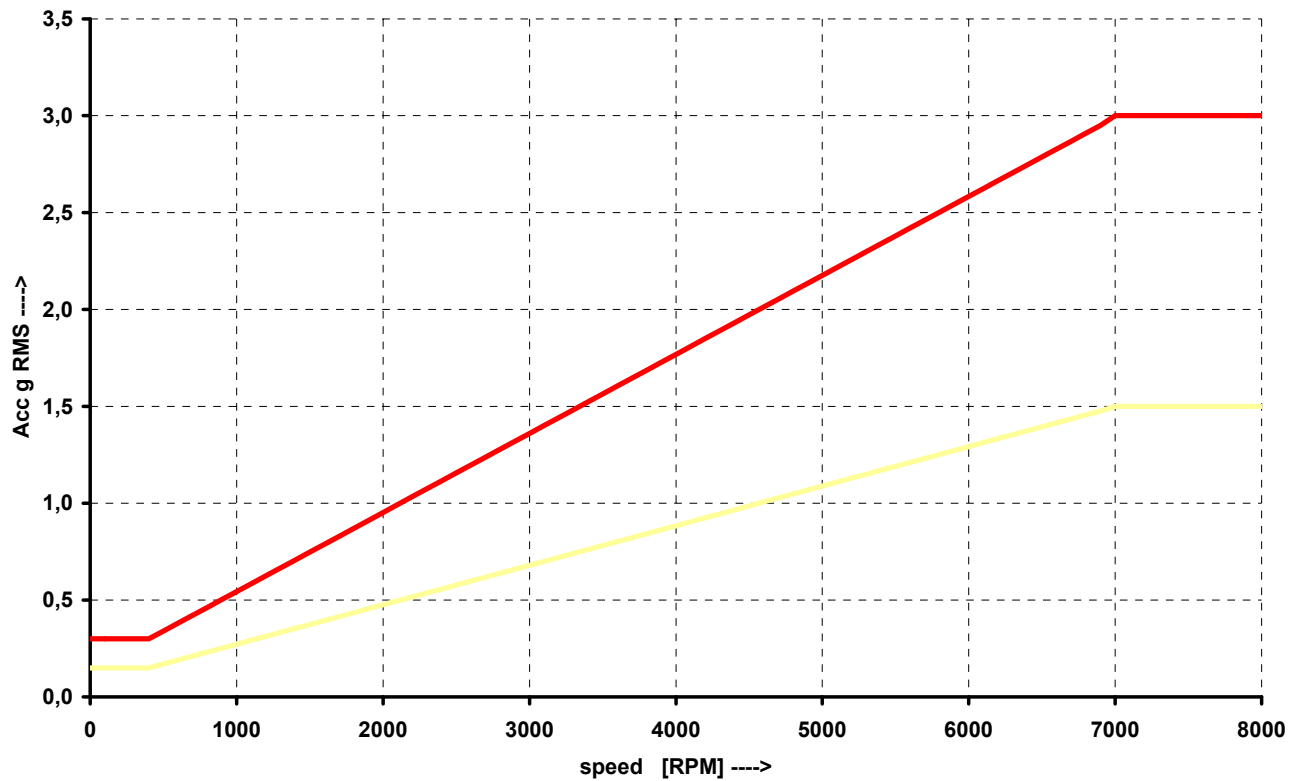

Unbalance, Misalignment and Looseness

The FASIT mode also advises you, what the most probable source of vibration is. The three individual bars are displayed.

The Stethoscope

This mode enables listening of vibrations. Use the standard headphones and connect them to the audio output on top panel.

Select the Stethoscope mode and push **OK**. The 4 displays appear. Push **START**. Each input signal level will be displayed.

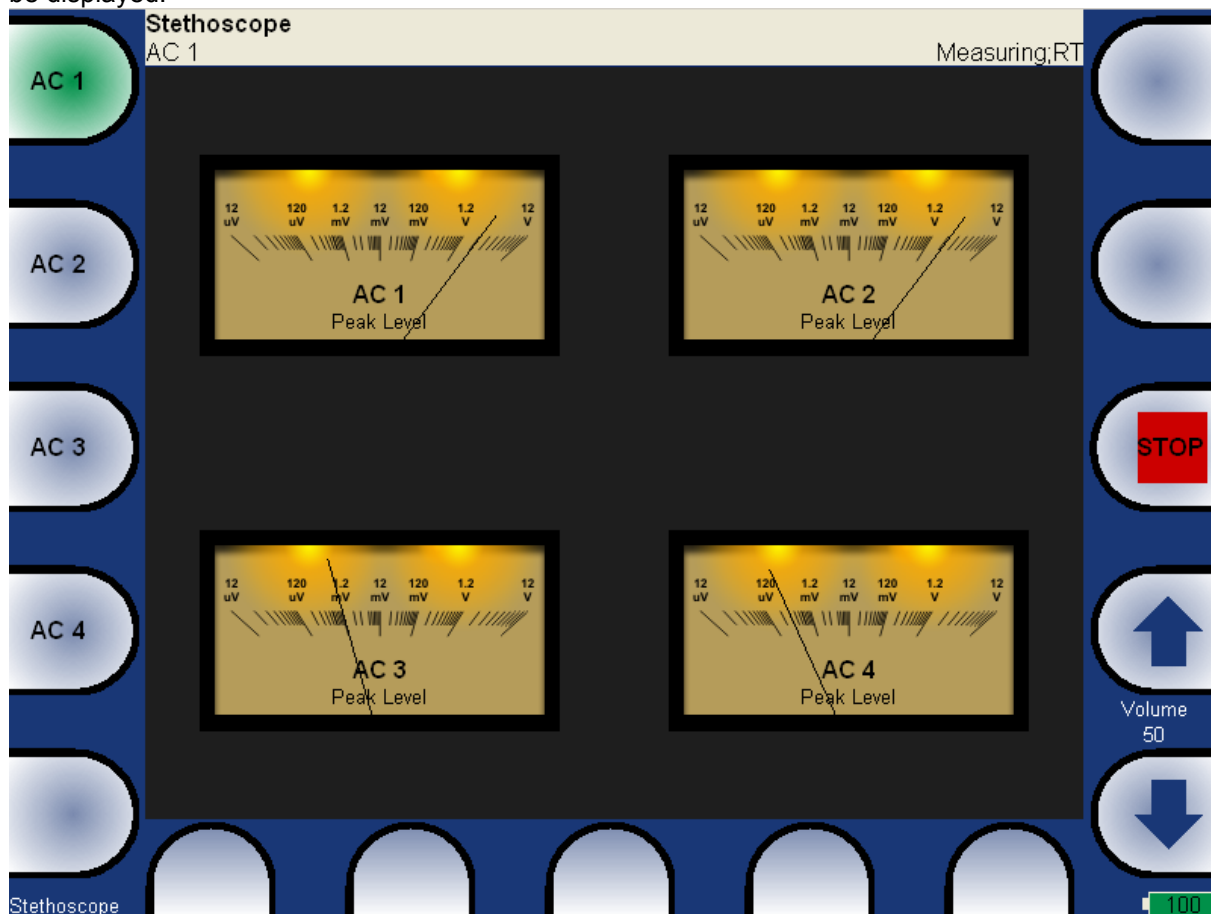

The TRUE PEAK level is displayed. By buttons on the left side you choose the channel for listening. The volumes buttons are on right side.

The delay of audio output

Because all signal conditioning is digitally arranged, the delay of signal appears. Typically the delay is 1 sec. You can clearly test to knock to the sensor and you will listen this knock after the delay time.

Playback Settings

For **Playback speed** settings push **Playback Settings** button and select the value.



The Lubri - the greasing control

There is an increasing demand for an instrument which is able to simply check lubrication of rolling bearings and also the condition of these bearings.

Every machine does have in its specifications how much lubricant every one of its bearings uses in a specific amount of operational hours. A task of each technician or engineer is to regularly check all the lubricated points and maintain lubricant at sufficient levels. Either state, lack or excess of lubricant are harmful for a rolling element bearing. The result is always excessive stress on the bearing and consequently excessive wear. Every lubricating point has a lubrication time interval (in hours of service) and also an amount of lubricant that needs to be replenished. This manner of lubrication control has a significant disadvantage.

The amount of lubricant that any bearing actually needs for proper operation changes during its lifetime. Longer lubricating intervals in the case of a new machine are usually not sufficient for a machine after several years of operation.

It is clear that it would be useful to be able to determine a state of a bearing somehow and replenish only as much lubricant as is actually needed. Controlled lubrication increases bearing service life and lowers costs for lubrication and repairs.

The main use of this Lubri mode is in the lubrication replenishment process. During this process the mode measures the actual lubrication condition of a bearing and tells the operator when the amount of lubricant is ideal. This way it is ensured that we do not under or over lubricate.

This mode exactly determines the ideal amount of lubricant needed.

As a result, your machines will be maintained in their best lubrication condition. The Lubri mode enables you to make the whole lubricating process simpler and it normally reduces the consumption of very expensive lubricants.

Two Possible Ways How to Measure

A standard accelerometer (sensitivity 100mV/g and ICP power) mounted on a bearing housing is used to measure lubrication.

You have two possibilities how to do this:

1 The sensor is mounted on a lubrication head.

This option enables a quick service since the lubrication head is transferred together with the sensor. The disadvantage is a partial loss of sensitivity, since the lubrication head attenuates the measured signal.

2 The sensor is mounted next to lubrication point on a bearing housing (measurement pad recommended). This option enables a perfect measurement. The disadvantage is a longer preparation, since the lubrication head and sensor must be mounted separately.

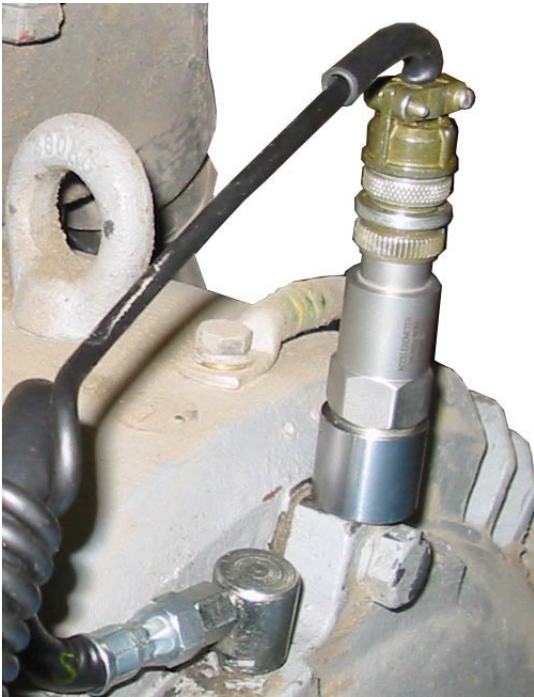

Sensor mounted near to lubrication point

If vibration diagnostic measurements are performed on a machine, then a measurement pad is already mounted. This pad can be used also for lubrication measurements.

The procedure

1. Mount the sensor near to the bearing. Prepare the greasing gun for use.
2. Select the Lubri Mode and the input channel, which will be used for measurement. Push the **START** button. Then the instrument will automatically measure an actual lubrication state.

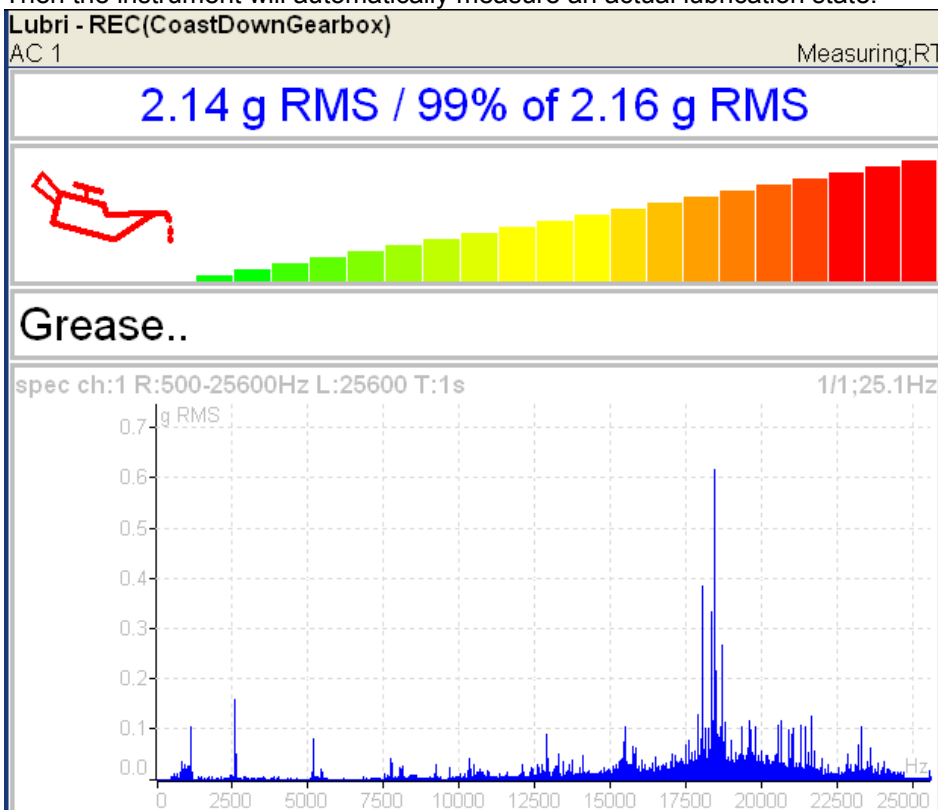

In the beginning the instrument takes the initial g RMS value in the frequency band 500 - 25600 Hz.

The first line contains the actual g RMS value (re-triggered) and the proportion to initial value in %. Below first line is horizontal bar, which always reaches a maximum level after procedure start.

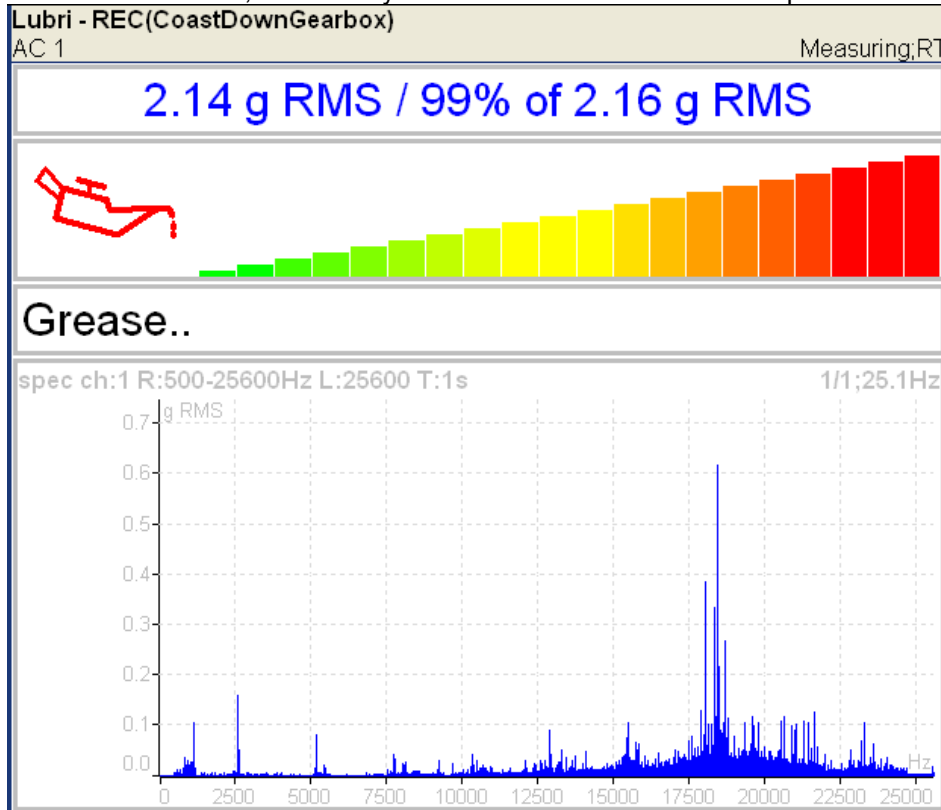

You need to slowly start adding lubricant, while monitoring the height of the column on the display. Usually there is not much going on in the beginning, which means that the lubricant is pushed toward the bearing, however it is not there yet. At the moment when the lubricant reaches the bearing, the column decreases (usually its red part disappears and only the green part remains). You need to add a little more lubricant, and if there is no further decrease, you end the lubrication process.

If, at the beginning of measurement, value of vibrations and oil can are green, then the signal from a bearing is very low. We have either new or a very well greased bearing.

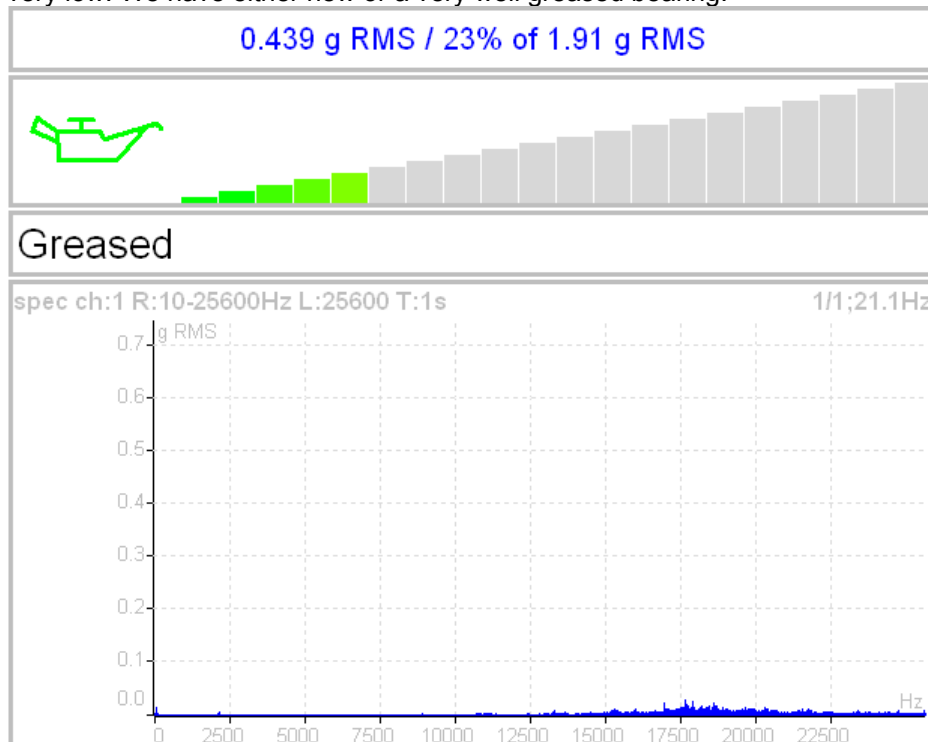

The recommendations are also displayed below the bar.

The acceleration spectrum is displayed in the bottom. You can look at the spectrum changes during the procedure. You can find more detailed information about lubrication in the A4910-Lubri manual.

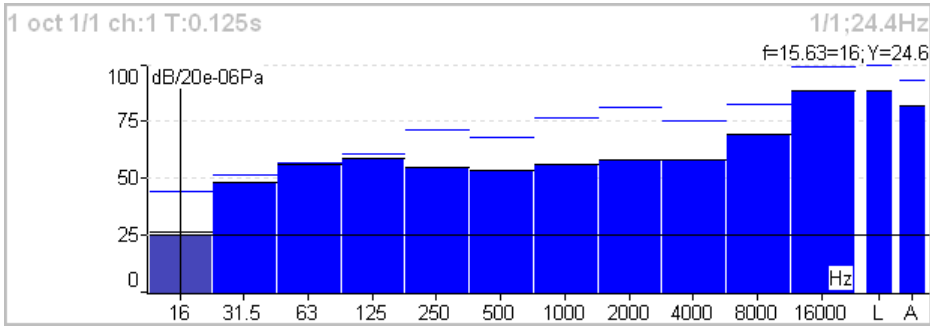

Each spectrum is combined with two bars at the right side. The total sound level **L** and the used weighting level **A-D** are displayed. The line over each line is the maximum peak reached during the measurement.

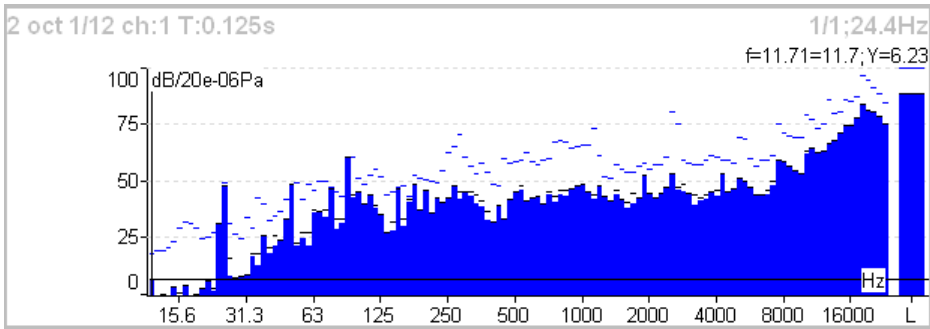

For each line is used also the short time peak memory. It looks like snowing.

Bump Test

It enables to find the resonance frequency of machine body. Set the used channel and the number of hits for averaging.

Test contains two parts. The level of amplitude trigger is found in the first part. The response spectrum is developed in the second part.

Settings

Channel:	1
Hits:	4
Save	

Channel channel with the accelerometer

Hits number of hits

Amplitude trigger setting

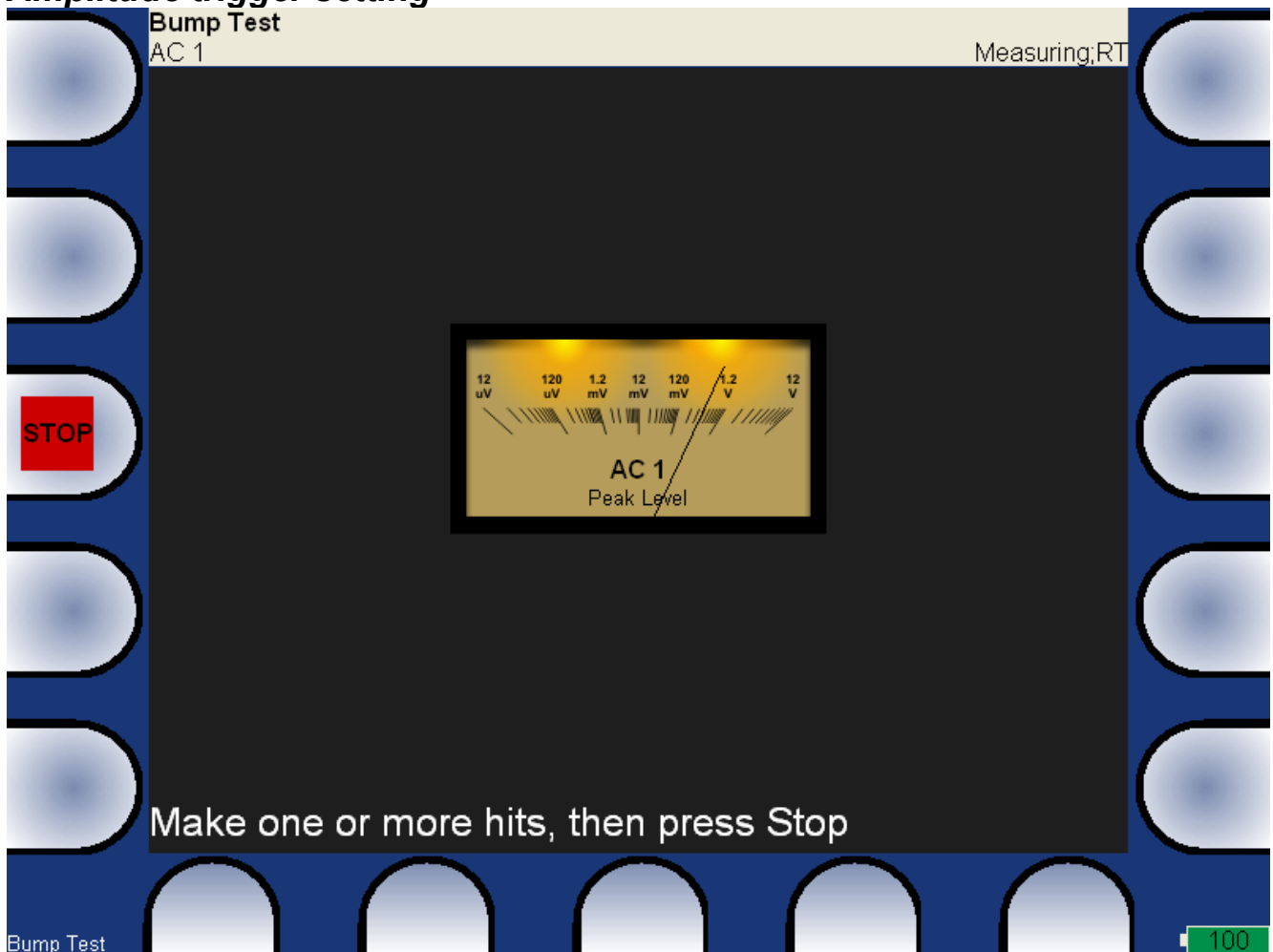

In the first part of test we need to detect the correct value for triggering. Make the hit and look the moving of the hand on display. Make all hits with the same force. More then one hit is recommended (3-4). Push **Stop** to finish it.

Response spectrum

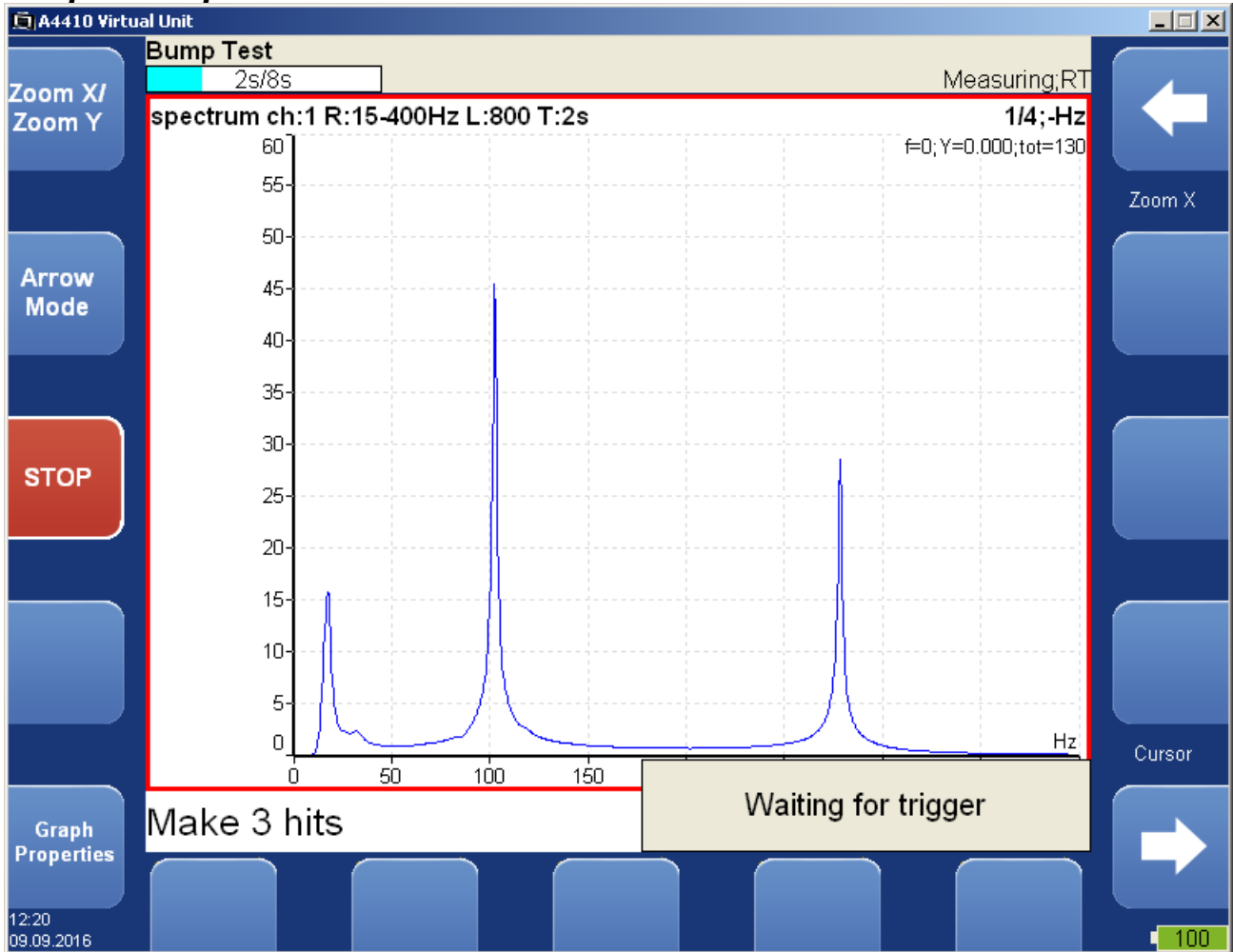

In part 2 continue with hits. The spectrum is displayed after first hit and the the average is used for next hits. Look at the top right corner and make the hit only when the message **Waiting for trigger** is displayed. You can stop the test anytime by **Stop** button. Spectrum graph has the same properties like in Analyser mode.

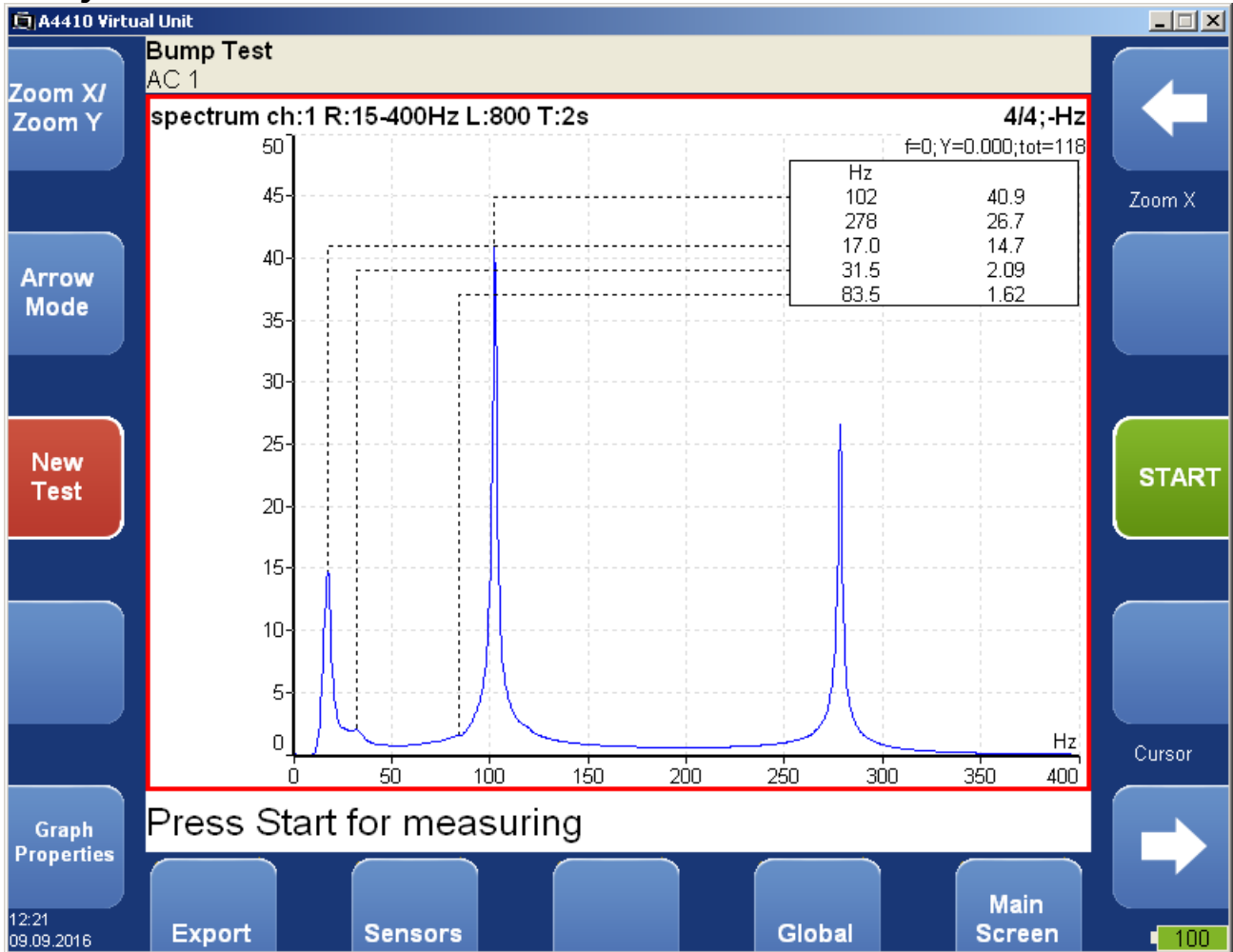

Using of the **Peaks list** helps to detect required frequencies.

- Start** repeats part 2 (the same trigger level)
- New test** new test
- Export** spectrum export to VA4_DISC

ADS

The Adash Deflection Shapes mode enables to measure operating deflection shapes of the machine.

ADS project

The project must be created on the computer. The ADS software enables to create the geometry of the machine (points, lines and directions).

Import of project from computer to VA4

Copy the project file (ads extension) to VA4_DISC (to the root or VA4ads folder). The project will be moved to the VA4 memory after entering the ADS module. The file in VA4_DISC will be deleted.

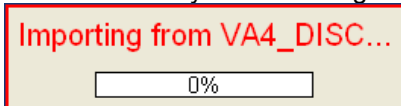

Rewriting of geometry

Usually the user creates the simple geometry firstly and takes the measurements. After that first test he changes the geometry (adds the next points, lines and directions). When the project is imported to the instrument again then only the geometry file will be rewritten. The already taken data will not be deleted.

Project menu

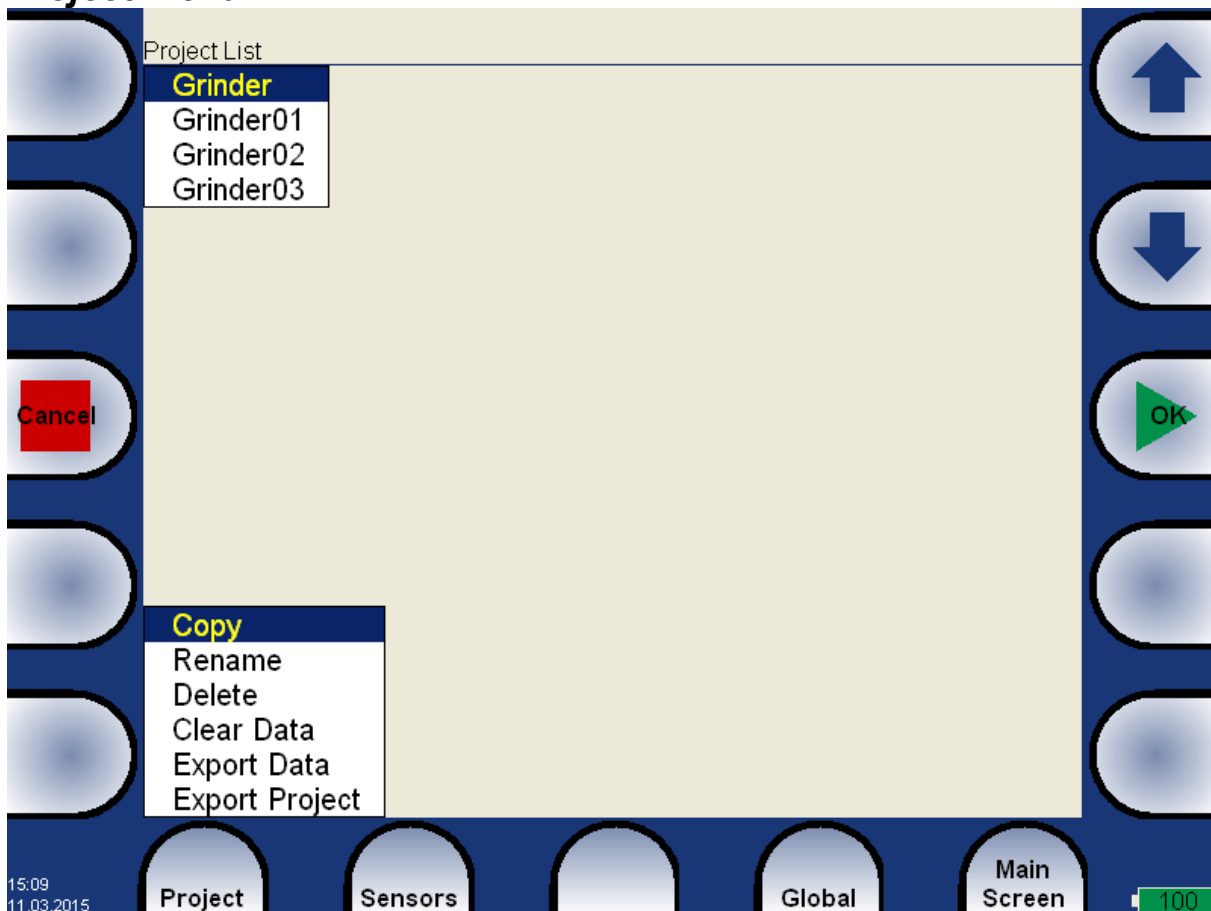

Copy of selected project to new project.

Rename

Renames project.

Delete

Deletes project.

Clear Data

All readings (measurements) will be deleted.

Export Data

Export of readings (measurements) to VA4_DISC. File with dsd extension will be saved to VA4ads folder. Here is prepared for download to the computer.

Export Project

Exports both of data (readings and geometry) to VA4_DISC. It could be useful when user wants to use A4410 Virtual Unit software for next readings.

ADS Settings

The settings of parameters are required when the project is opened first time.

ADS Settings

Type:	fresp
Input:	1
Window:	hanning
Output:	2
Window:	hanning
Result Type:	H1
Range[Hz]:	800
	fs=2048Hz
Lines:	800
	t=1s,df=1Hz
Avg:	4
	total t=4s
Overlap:	0%
Reference Direction:	1
Frequency for Animation [Hz]:	50

Buttons: Cancel, Save, OK, Up, Down, Right

3D Diagram: Shows a sensor array with points 1, 2, 3, 8, 9, 10, 11 and a coordinate system (x, y, z).

Footer: 15:10, 11.03.2015, 100

Measurement definition

The 1x amp+phase, orders and frf are available measurement for ADS. All parameters are the same as in Analyser mode.

The settings you can change any time later, use the ADS Settings button.

The change of measurement parameters requires to delete all saved readings, because they are not compatible with old definition.

Reference direction

This parameter is available only for frf measurement with two accelerometers. One reference sensor is mounted to one point (one direction) on the machine and is on that place all the time. The second sensors is moved sequentially to all other directions.

The change of Reference Direction number requires to delete all saved readings, because they are not compatible with new reference direction number.

Frequency for Animation

This frequency will be used for animation on VA4 screen. It works only for frf measurement. In case of 1x amp+phase or orders will be the speed frequency used (1X).

Views

Three types of screen view are available.

Machine View

The geometry is displayed. The directions contains the numbers. The reference direction is marked as R. Just selected point contains the small circle. Just selected direction is drawn by different color.

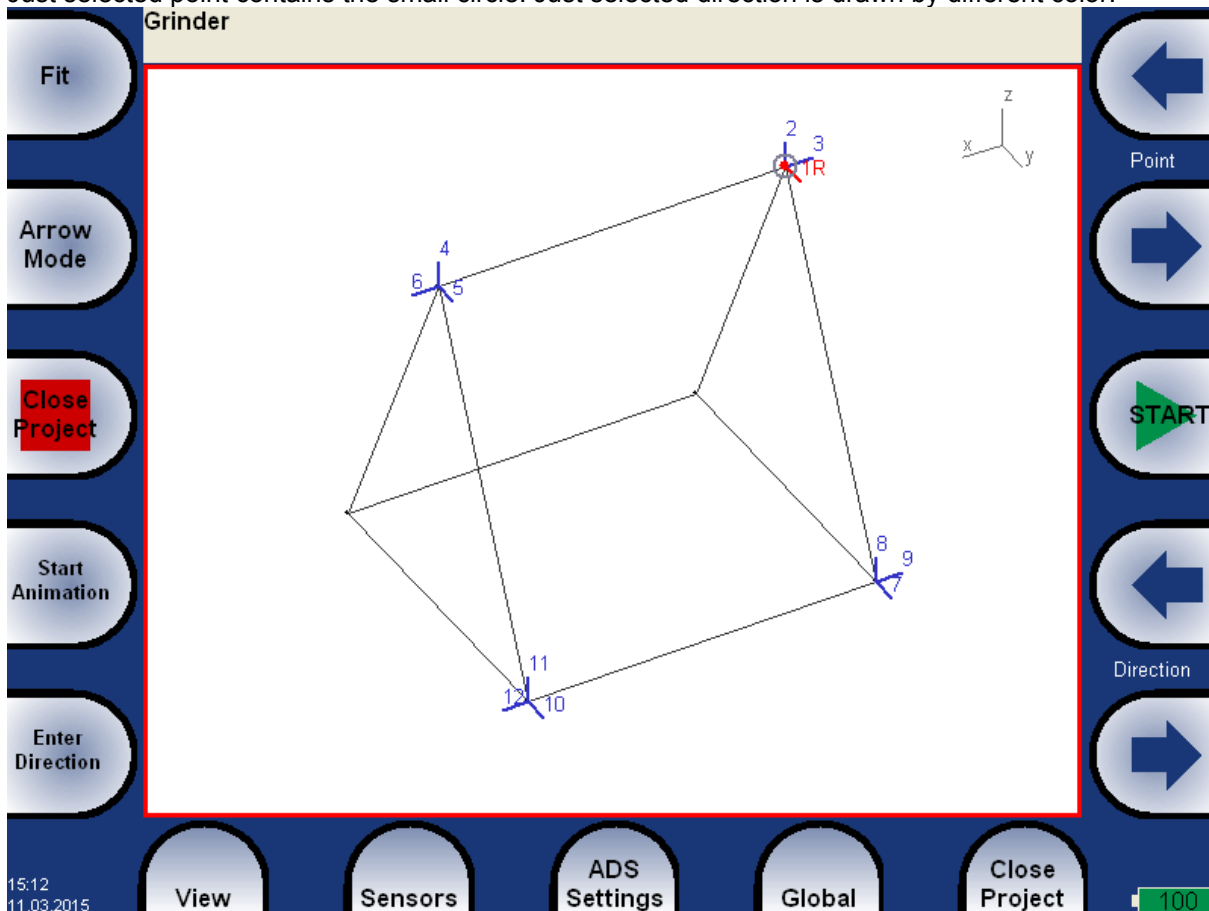

Measurement View

Standard graph display. The number of selected direction is displayed in front of measurement type (2 frf)

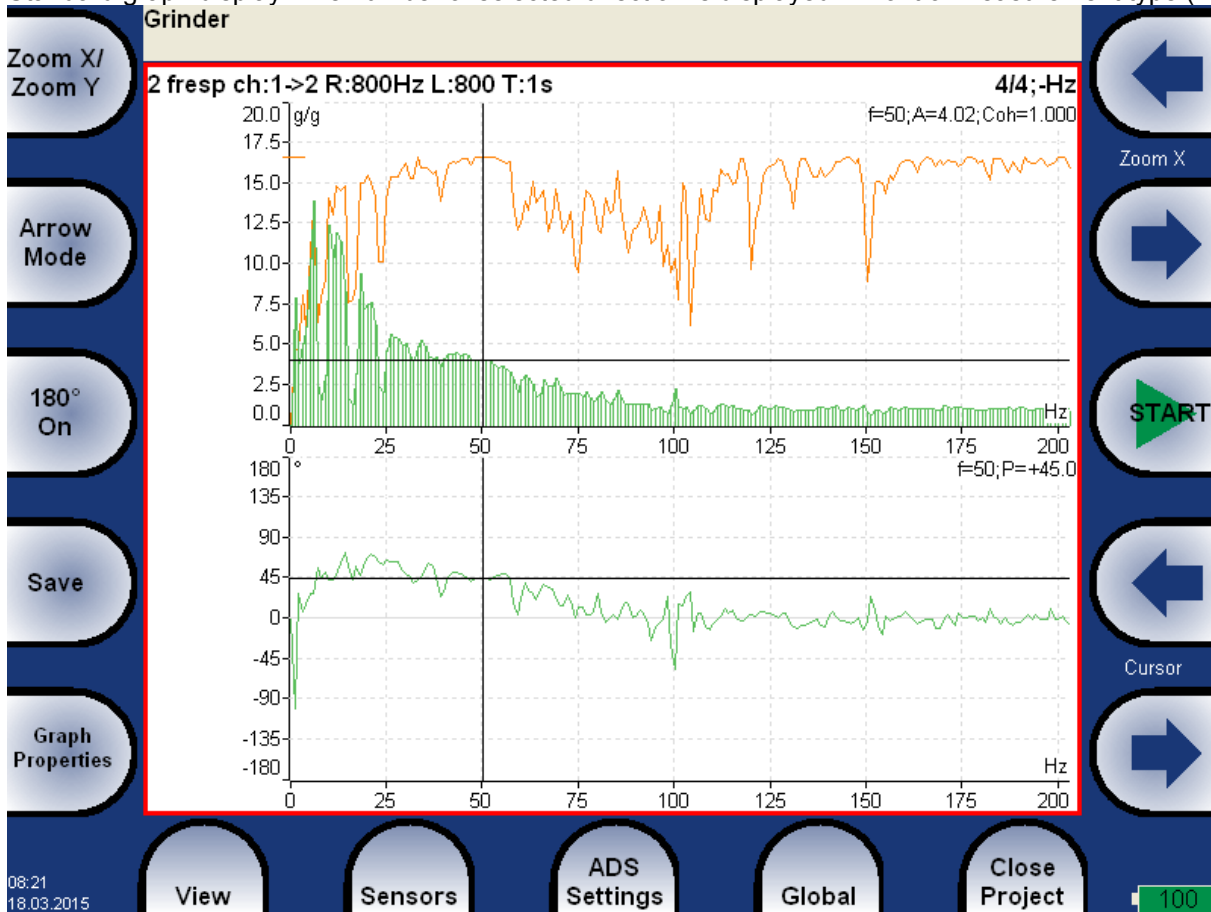

Machine+Measurement View

Both previous screens in one together. The user can select one of them (the red border) and to work with it. The different set of buttons are displayed for every selected area of screen.

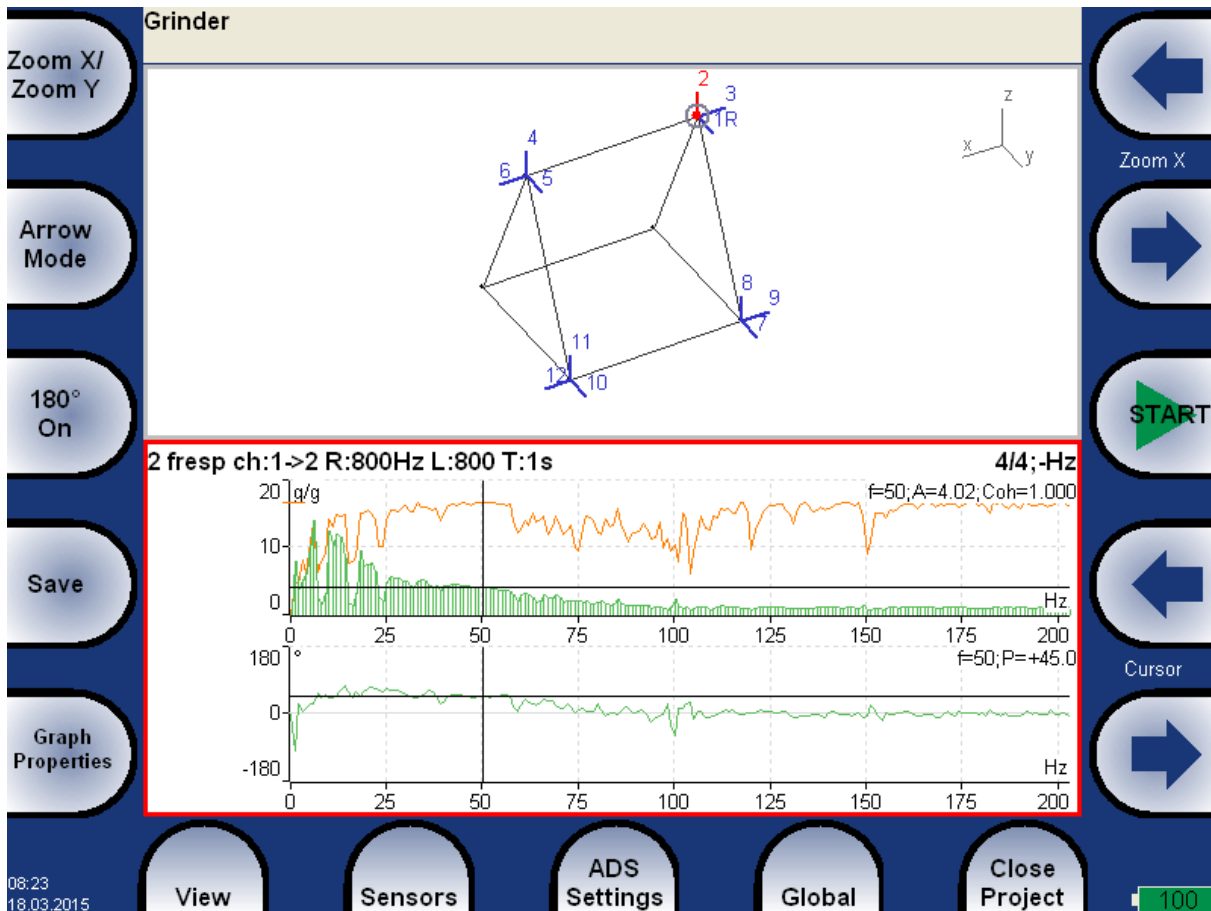
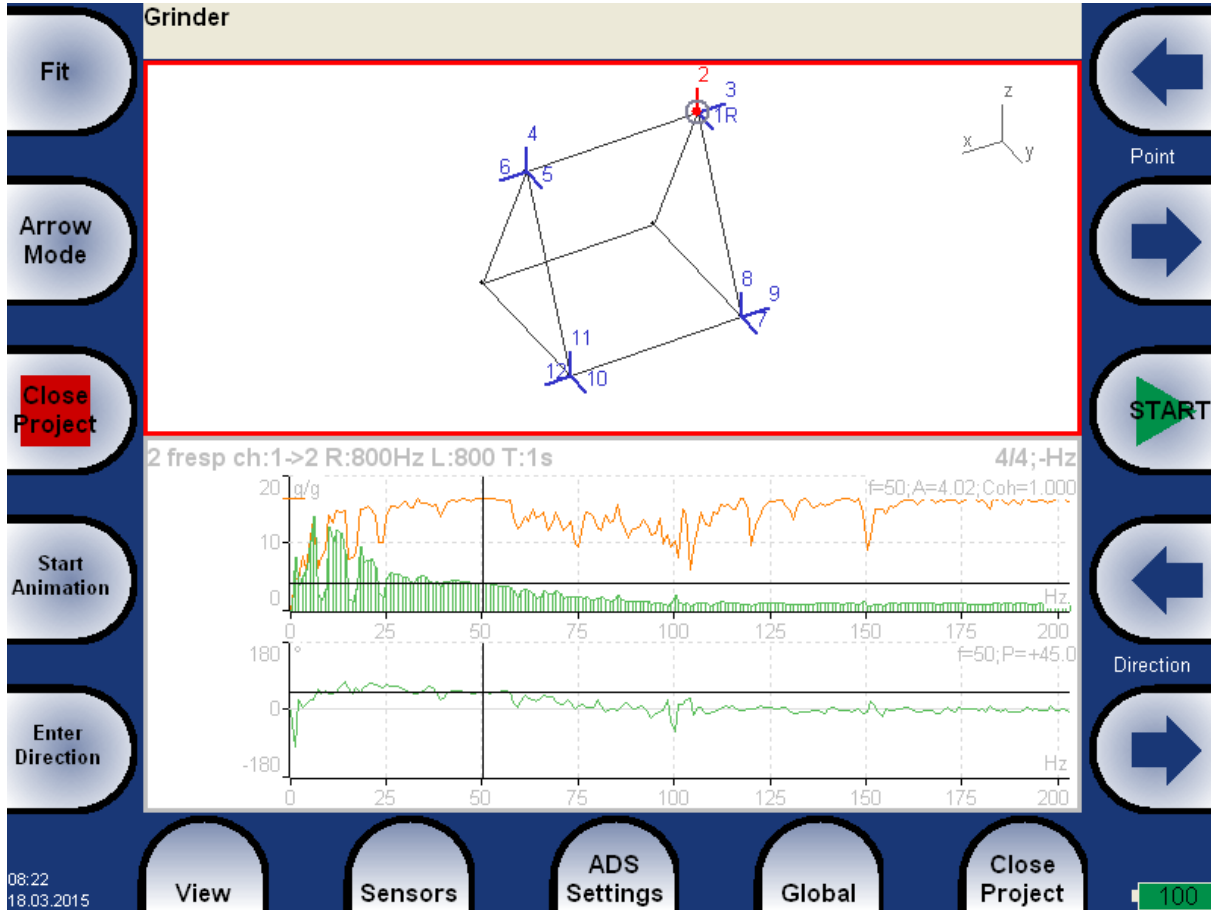

Automatic change of view

When the measurement is ran, the machine view replaced by measurement view.

Buttons in Machine View**Fit**

Auto-zoom of machine in window.

Arrow Mode

Changes the arrows functions.

Point

Moves the point selection (blinking circle). When the new selection is confirmed by OK, then the selected direction is also moved to that point.

Direction

Moves the direction selection (on selected point). The new direction for measurement can be manually entered by **Enter Direction** button.

Zoom/Move/Rotation

Zoom/Move/Rotation of machine.

Blink on/Blink off

The directions which are not measured yet can be blinking.

Hide on/Hide off

The directions which are measured yet can be hide.

Start/Stop Animation

Run or stop animation.

Enter Direction

Manual entry for direction number.

Start

Starts new measurement.

Buttons in Measurement View

The most of buttons have the same function as in Analyzer mode.

180° on/180°off

Sometimes it is possible to mount the sensor to direction which is defined in geometry. Usually in such case is possible to mount the sensor in opposite direction. The use this button and change the phase of 180 degrees.

Save

Saves the measurement (reading). In the first row are displayed: direction number, amplitude, phase on selected speed.

Grinder

2: A = 5.69 g 0-P, P = +45.0°, f = 50 Hz

Ultrasound

Introduction

We would like to explain a few terms in the beginning of this chapter.

Higher frequency energy above 20kHz is best detected with an ultrasonic sensor. Most useful information is found between 30 and 50kHz. The Adash ultrasonic module enables monitoring ultrasonic energy.

Ultrasound utilizes a solid, liquid or gas to transmit (will not exist in a vacuum), and is a very directional and short waveform. It has several things in common with the vibration, for instance the ability to detect the ultrasound energy requires the sensor to be focused in the direction of the waveforms.

Field applications for airborne ultrasound detection:

- Consider the wave energy is easily reflected and attenuated.
- When looking to detect airborne ultrasound energy a rule of half distance twice amplitude is a good thing to consider, this is called the “inverse rule”.
- Remember airborne ultrasound is easily reflected, when detecting a leak, you should turn in the other direction to determine if the sound is coming from behind you.
- Use shields such as cardboard or to isolate the potential defect from other sources.

For airborne ultrasound the instrument microphone attachment will detect:

- Air leaks
- Vacuum leaks
- Electrical Arcing
- Electrical Corona
- Tightness testing where a signal generator is located within a sealed unit, then by scanning the sealed areas from the outside leaks can be detected.

The probe attachment that enables direct transmission ultrasound will detect:

- Early signs of poor lubrication in anti-friction roller bearings
- Impacting noise from defects in roller bearings including bearings with shaft speeds under 100 rpm.
- Steam trap leakage and failures
- Gearbox defects
- Valve leakage
- Actuator malfunctions

Sensor setting

The ultrasound measurement is available only on AC CH1. You need the ultrasound microphone for that. When you run the module, then the sensor is changed automatically to Pascal sensor.

Used Sensor
on AC1: 200 mV / Pa, ICP off

Use the **Sensors / AC1** to change the sensitivity if needed. The new setting is saved and used in next run. The original sensor is set, when you leave the module.

Settings

You can set the range of measurement. Use **Menu / Ultrasound Settings**. Enter required range.

Scale - minimum:	0
Scale - maximum:	120
Save	

Measurement

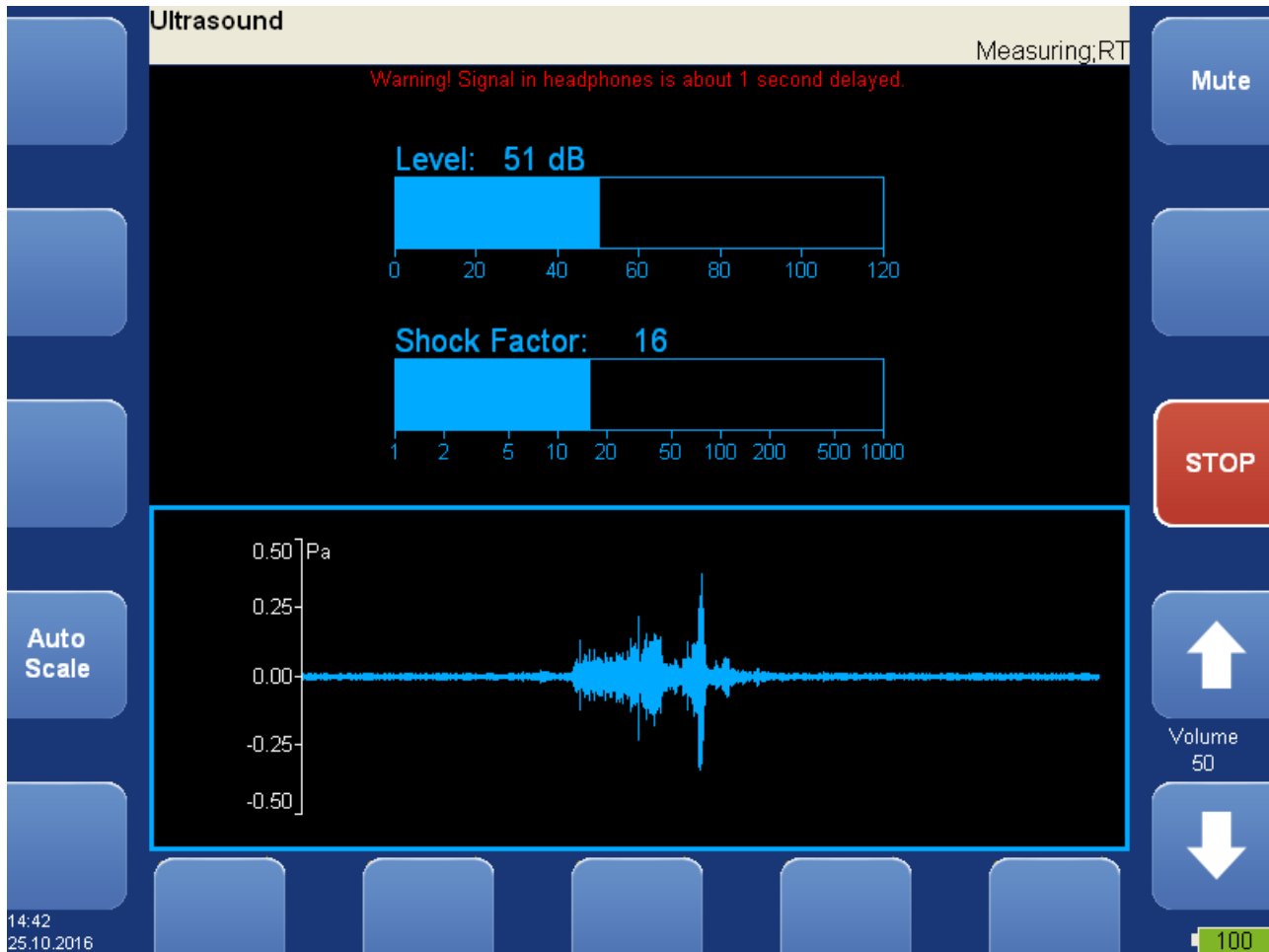

Press **Start** button. Two values are displayed. The **Level** of sound in dB and **Shock Factor**. The Shock factor is defined as Peak value divide by RMS value. It means value 1.4 for pure sine. Higher values means that transient shock events are in the sound signal.

The time waveform is displayed at the bottom of the screen. Use **Auto Scale** button to fit the scale of the graph. Press **Stop** to stop the reading.

Listening

The ultrasound is demodulated to the frequencies around 1kHz and you can hear it in headphones. Use the volume buttons to set the correct level.

Important note !

The signal in headphones is delayed 1 sec. It is because of digital processing, which takes this time.

A4410 Virtual Unit

A4410 Virtual unit is the personal computer application. It emulates the A4400 analyzer on your computer screen. The A4410 Virtual unit is designed for measurement with the **A4404 - Signal Analyzer Box** (it is the 4 channel signal box with USB connection to the computer). The demonstration purposes is the second use.



Installation

Download, uncompress the **A4410_VirtualUnit_verXXXX.zip** file (XXXX represents the version number) and save it to selected disc and folder (e.g C:\VirtualUnit).

Compressed file contains **A4410_VirtualUnit_verXXXX** folder, which contains:

- 1) **data** folder for application data (e.g. projects)
- 2) **bin** folder with binary files
- 3) **runme.bat** file for launching

Attention !! : **A4410_VirtualUnit_verXXXX** folder must not have limited access for user (e.g.readable only). Contact your IT person if you are not familiar with such conditions.

A4404 – Signal Analyzer Box drivers installation

The A4404 - Signal Analyzer Box needs special drivers. Follow next instructions:

- 1) Download FTDI drivers file from www.adash.cz Download section / Third parties software / A4404 VA4 Box driver / CDM20828_WHQL_Certified.zip
- 2) Uncompress the file into any selected directory (e.g. C:\CDM20828_WHQL_Certified).
- 3) Connect the A4404 - Signal Analyzer Box to your PC via USB cable.
- 4) If drivers are not installed already in your computer, then the **Add hardware Wizard** window will open and you follow next steps.
- 5) Select **Install from a list or specific location** and click the **Next** button (do not accept any automatic downloads).
- 6) Check **Include this location in the search**.
- 7) Click the **Browse** button and select the driver folder, where you uncompressed the file (e.g. C:\CDM20828_WHQL_Certified).
- 8) Click the **Next** button and wait for installation completing.
- 9) Delete the driver folder (not required).

License file

The A4410 Virtual unit needs the license file **adashx123456.a44** to be running with the A4404 - Signal Analyzer Box (the 123456 is the serial number of A4404). Copy this file from the CD (it is attached to your A4404 - Signal Analyzer Box unit) to the **A4410 Virtual unit/data/VA4licence** folder.
The ver.0226 and older use the file name **adash.a44**.

Update

If you would like to upgrade your older version, delete the old one and install the new one. However if your old version contains data (**data** folder) you need to keep them, you must not rewrite them.

Follow the instruction to keep your data:

- 1) Uncompress the new version to the new folder.
- 2) Delete **bin** folder in the old version folder.
- 3) Copy the **bin** folder from the new version to the old version folder.
- 4) If the old version folder contains version number, rewrite it to the new number (it has no effect for running).
- 5) Delete the new version folder.

Alternative instructions to keep your data:

- 1) Uncompress the new version to the new folder.
- 2) Delete the **data** folder from the new version.
- 3) Copy the **data** folder from the old version to the new version.
- 4) Delete the old version.

Operation

Use the **runme.bat** file to launch the application or run directly the **VA4.exe** in the **bin** folder.

The A4410 Virtual unit contains the same functions as the portable instrument. See A4400 manual for all information. The only difference is in controlling of the Virtual unit, which is controlled by mouse and keyboard. Live signal is measured only with the A4404 - Signal Analyzer Box. Without this unit it's possible to process records (See A4400 manual to get info about acquisition and processing of records). A4410_VirtualUnit contains one record (**Default Rec**) for demonstration. Next records you need to measure directly or import them from A4400 VA4Pro unit (see A4410 - Virtual unit and A4400 VA4Pro connection chapter below).

VA4_DISC

VA4_DISC folder is created in the **A4410_VirtualUnit_verXXXX** folder after the first run of the application. A4410 Virtual unit use VA4_DISC folder the same way as the real instrument.

VA4_DISC Folders Structure

- VA4analyser** - analyzer projects are exported here
- VA4balancer** - balancing projects are exported here
- VA4balancer_protocol** - balancing reports are exported here
- VA4route** - route projects are exported here

VA4runup - runup projects are exported here

VA4recorder - records are exported here

va4ver file - unit version information (for DDS)

These folders are created when the unit needs them, not actually in the first run.

A4410 Virtual unit with the DDS connection

Press the **Find** button in the DDS VA4Pro window for instrument connection and find manually (**Find** button) **A4410_VirtualUnit_verXXXX\VA4_DISC** virtual unit folder or the **A4410_VirtualUnit_verXXXX\Data** folder.

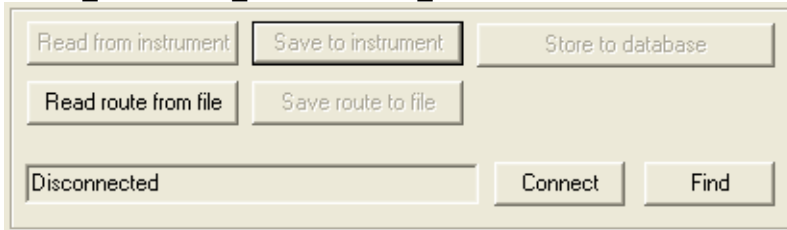

Connection of the Virtual unit with the DDS is done the same way as with the A4400 Va4Pro instrument. It is possible to copy projects to and from DDS to and from the A4410 Virtual Unit.

If the DDS and the Virtual unit are not installed on the same computer then you do not reach the DDS via network. It is possible to copy the VA4_DISC to the flash drive memory which can be connected to the computer with DDS. For DDS is important to find the standard VA4_DISC folder structure. It is not necessary to copy all VA4_DISC folders, however directory structure has to be kept (that means the Analyzer projects has to be in VA4analyser folder, etc.).

!!! Attention: VA4_DISC which should be read by DDS have to contain **va4ver** file. Don't forget to copy this file, when you copy the VA4_DISC folder.

A4410 Virtual unit and A4400 VA4Pro connection

How to share projects between the real and virtual unit will be described in this chapter.

Connect the real Va4Pro instrument to the computer with installed Virtual unit (via USB cable). The VA4Pro unit will be found as **VA4_DISC** (removable disc) on your system. It's possible to copy the data to and from the Virtual **VA4_DISC** folder.

Copying projects to the VA4Pro instrument

Copy the **A4410_VirtualUnit_verXXXX\Data\VA4analyser\ProjectName** project folder (ProjectName is your folder name which you want to copy) into the VA4Pro **VA4_DISC\VA4analyser** folder (**VA4_DISC** is the real removable storage device here, NOT the virtual unit folder !!!). You have to create empty file with the name **script.dds** in VA4Pro **VA4_DISC\VA4analyser** after project copy (it has the label sense only). RunUp and Route projects (*VA4runup* and *VA4route* folders) are copied the same way. Next mode projects are not available to copy.

Example:

We've got the analyzer project called Power Station in the virtual unit and we want to add it to the real instrument.

- 1) Connect the instrument with the computer.
- 2) **VA4_DISC** removable storage device appears. Open **VA4analyser** folder on this device.
- 3) Open **A4410_VirtualUnit_verXXXX\Data\Va4analyser** folder. Find **Power Station** folder in this folder. Copy folder into the VA4Pro **VA4_DISC**.
- 4) Create the empty file **script.dds** in VA4Pro **VA4_DISC\VA4analyser\Power Station** folder.

Projects and records copy from the VA4Pro instrument

!!! Attention: Projects has to be exported to the VA4Pro **VA4_DISC** first (the same as export to the DDS).

Copy the VA4Pro **VA4_DISC\VA4analyser\ProjectName** (the real removable storage device here, NOT the virtual unit folder!!!) into the **A4410_VirtualUnit_verXXXX\Data\VA4analyser** folder. In this case there is no

need of script.dds file. RunUp, Route, Records and Balancer projects (VA4runup, VA4route, VA4recorder and VA4Balancer directories) are able to copy.

Example:

We've got the analyzer project called Power Station in the real instrument and we want to add it to the virtual unit.

- 1) Connect the instrument with the computer.
- 2) **VA4_DISC** removable storage device appears. Open **VA4analyser** folder on this device. Find **Power Station** folder in this folder.
- 3) Open **\A4410_VirtualUnit_verXXXX\Data\Va4analyser** folder.
- 4) Copy the **Power Station** folder from the VA4_DISC into the **\A4410_VirtualUnit_verXXXX\Data\Va4analyser** folder.

The Virtual Unit vs. the real instrument differences

- The Virtual unit use VA4_DISC directory for export and import instead of VA4_DISC flash drive.
- Update button does not work in the Virtual unit (see instructions above for Virtual unit upgrade).
- The Virtual unit application runs in window.
- It is not possible to measure live signal without the A4404 - Signal Analyzer Box.

Appendix A: Technical Specification

Inputs

Dynamic Channels (AC)

Number of synchronous parallel channels (AC):	4 AC
Frequency range:	max 90000 Hz (196 kHz sampling frequency)
Input range:	+/- 12V (only one range, no gains)
Measurement timing:	fully synchronous
A/D Resolution:	24 bit input, 64 bit double floating point internal precision (no gain procedures used !)
Dynamic range:	120 dB
Channel configuration:	voltage or ICP (individually for every channel)
Input protection:	up to 30 V
Input impedance:	100 kOhm
Input type:	acceleration, velocity, displacement, any non-vibration AC voltage
Integration:	single, double fully digital integration
2D Processing:	axis rotation according sensor mounting
Accuracy:	< 0.5 %
ICP drive:	18 V, 3.8 mA
High pass filter:	1Hz -12800 Hz (user definition)
Low pass filter:	25Hz -90000 Hz (user definition)
Connector:	Binder 712 series

Tacho Channel

Number:	1 independent tacho input
Speed range:	0.01Hz - 1000 Hz
Input impedance:	80 kOhm
Input type:	voltage
Input range:	+ 10V (only one range, no gains) or +/-30V (tacho signal + DC) with optional tacho signal converter
Accuracy:	<0.5 %
Trigger level:	0.1 -9.9 V, user defined
Input protection:	up to 48 V
Connector:	Binder 712 series

Static Channels (DC or 4-20mA)

Number:	4 DC or 4-20mA (has to be specified in order)
Input range:	+/- 24 V or 4-20mA
Input impedance:	100kOhm (V-DC), 250 Ohm (4-20mA-DC)
A/D Resolution:	12 bit input
Accuracy:	0.1% fsd
Input protection:	up to 30 V

Measurement Functions

Data Analysis Speed:	0.1 sec for 25600 lines FFT spectrum
Amplitude Units:	Metric, Imperial (English) or user programmable
Frequency Units:	Hz, CPS, RPM, CPM, Orders
Amplitude scale:	Acceleration, Velocity, Displacement, User defined
Scaling:	Linear or Log, both X and Y axes
Cursor:	Single, Harmonics, Sidebands
Triggering:	free run

	tacho
	amplitude (positive or negative)
	external (voltage)
Signal Range:	full, No Auto ranging
Data acquisition:	TRUE RMS, TRUE PEAK, TRUE PEAK-PEAK overall or band values
	user defined high, low and band pass filters for band measurement
	time waveforms (8 388 608 samples max)
	real-time FFT
	3D graphs (waterfall, cascade)
	order analysis
	Amplitude + phase values on speed frequency
	speed measurement
	process static DC or 4-20mA values
	Envelope demodulation
	ACMT procedure for low speed machines bearings
Time waveform samples:	256 – 8 388 608
Waveform (ACMT) length:	max 131 072 sec (36 hours)
Spectrum ranges:	25 – 90 000 Hz
Spectrum lines:	100 – 3 276 800
Spectrum Peaks listing:	yes
Spectrum units:	RMS, 0-P and P-P
Windows:	Rectangular, Hanning, Exponential, Transient
Order analysis parameters:	1/2 - 10th order
Averaging:	1-255
Overlap:	yes
Smax, Gap and Centerline displays for proximity sensors:	yes

Recording:

Sampling frequency:	user defined in range 64Hz - 196 kHz
Record length example:	3 GB for 1 hour record with 64kHz sampling (4ch AC+4ch DC+1ch tacho signal)
	(100GB memory enables over 30 hours of full 64kHz recording,
	lower sampling frequency enables much longer record))

Balancing:

Planes:	1 or 2
Speed range:	0,5 Hz - 1000 Hz
Balancing Advisor for automatic fault detection:	yes
Balancing Quality factor according ISO1940:	yes
Balancing vector graph for balancing process reporting:	yes
Balancing Report:	yes
Trim function:	yes
Vector split (e.g. to blades positions):	yes
Manual entry:	yes
Intuitive graphic user interface:	yes
Trial mass:	get out or leave in

General:

Processor:	Atom 1.6 GHz
RAM:	1 GB
Display:	LCD colour 174 x 127 mm (8.5" diagonal), 800x600 resolution
Memory (Internal SSD):	160 GB
Interface:	USB
Powering:	Li-Ion long life battery pack (more then 5 hours of measurement)
Operating temperature:	-10 °C - +50 °C, 15°F-120°F
EMC:	CE tested
Dimensions:	280 x 205 x 55 mm
Weight:	2.5 kg

Appendix B: ACMT bearing and gearbox measurement

Applications

The ACMT is the brilliant tool for condition of low-speed machines like paper machines, rolling mills, transport mechanisms... .

Description

Various processes produces short duration pulses are in slow speed machinery. Pulses are often caused by rolling element bearings, gearbox wear, etc. It is important to be able to accurately detect and analyse these pulses for correct diagnosis.

The individual pulse can have very short duration. Consequently it is necessary to set a high sampling frequency for measurement. Only in this way ensures to obtain a correct measurement of signal amplitude. The time interval between pulses can be very long when the speed is low (seconds, minutes). We need to see the time signal which contains several pulses as minimum for correct evaluation. The long length of time signal is required. This matter needs to use the low sampling frequency.

These two aspects produce the conflict in the measurement setting:

1. We need to use high frequency sampling for pulse measurement, which means the measured signal will very short e.g. 100ms. When the time interval between pulses is in seconds we have low chance to catch it. And we have no chance to have more pulses in one time signal.
2. We need the low sampling frequency for long time record e.g. 10s to obtain more pulses in one signal. But with such sampling we cannot measure the pulse, because cut out by anti-aliasing filter. If we switch off this filter, we have also no chance to catch it, because pulse duration is short and time period between samples is long.

ACMT is the solution

This method implements both contradictory requests by double sampling the data. The high sampling frequency is used in the beginning. Then the data are compressed. That is why we can take long time signal for evaluation.

Example

All measurements were taken on a slow-speed 23132-TOR rolling bearing rotating at 60 rpm (1 Hz). Outer race defect is on the bearing. The short pulses are generated during the operation.

We measure the signal with a record length of 4sec. When 2048 samples (standard value) is used, then 200Hz anti aliasing filter is used. We take the signal without any pulses. All of them are cut off by filter.

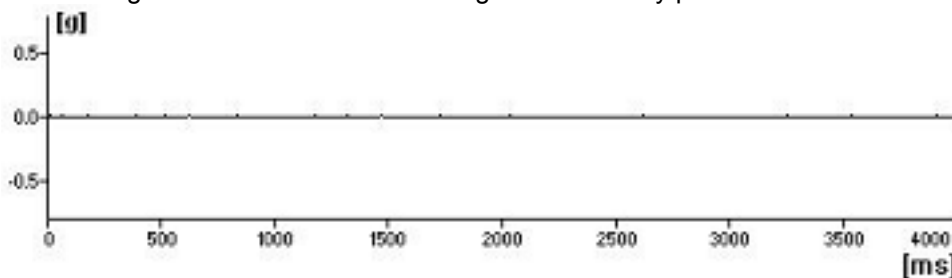

We use the 19200Hz sampling frequency. But we can measure only 42ms time signal. The time between the pulses is 114 ms. We need to be lucky and to hit the pulse.

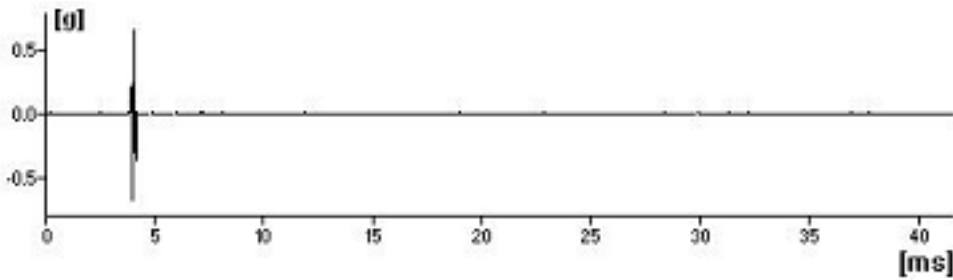

Next measurement uses the ACMT method. You see, it works. Long time signal contains required number of pulses and the peak of each of them is captured. That is what we need.

The ACMT method can do even more

Short duration pulses have usually small amplitude. They are often modulated by speed frequency. We use standard measurement and result is in the next picture.

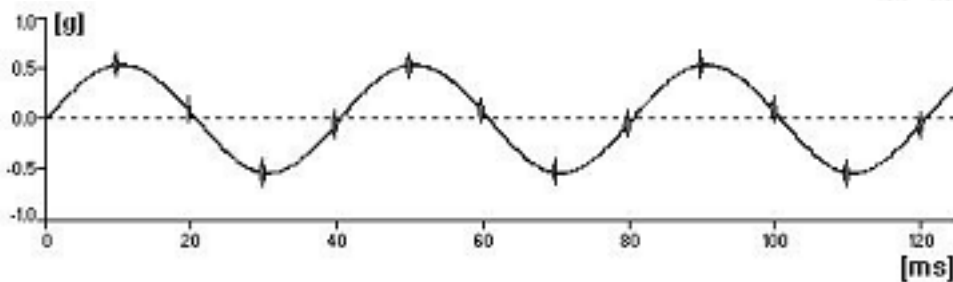
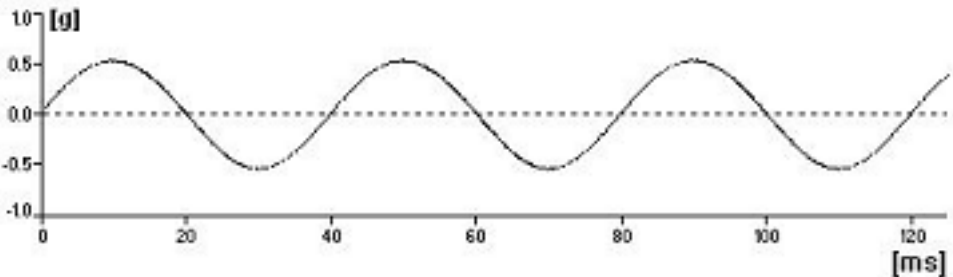

You see only speed sine wave and no or small pulses, which are filtered by anti aliasing.

The standard ACMT is used in next picture. We used the ACMT together with band pass filtering which removes the speed sine wave from the signal.

The all short-pulses are held and amplitude are modulated for better view.

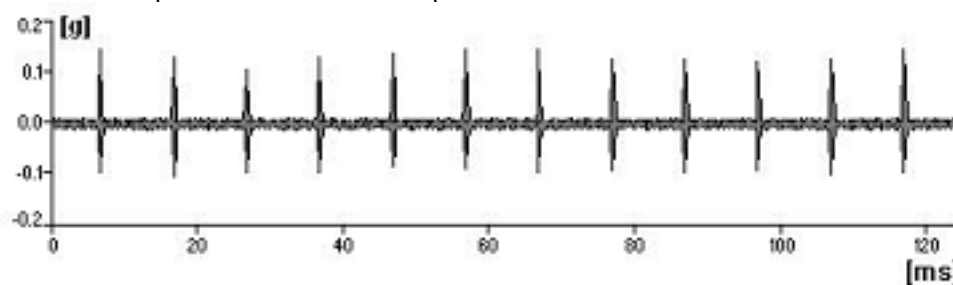

This result is much better, because Y axe scale corresponds with real pulses amplitude, not with speed sine wave amplitude.