

■ APPLIANCE MULTITESTER

C.A 6160



CONTENTS

1. GENERAL INTRODUCTION.....	p. 3
1.1 Safety in use.....	p. 3
1.2 Warranty.....	p. 4
1.3 List of measurements carried out by the instrument.....	p. 4
1.4 List of applicable standards.....	p. 4
2. DESCRIPTION OF THE INSTRUMENT.....	p. 5
3. TECHNICAL SPECIFICATIONS.....	p. 6
3.1 Withstanding test (PROG. HV and HV position).....	p. 6
3.2 Burn out (HV position).....	p. 6
3.3 Low resistance (Continuity position).....	p. 7
3.4 Voltage drop scaled to 10A~ (option in Continuity position).....	p. 8
3.5 Insulation resistance.....	p. 8
3.6 Leakage current.....	p. 9
3.6.1 Leakage current.....	p. 9
3.6.2 Touch Leakage current.....	p. 9
3.6.3 Substitute Leakage current.....	p. 9
3.7 Functional test.....	p. 9
3.8 Discharge time (DISC. TIME position).....	p. 10
3.9 General.....	p. 10
4. MEASUREMENTS.....	p. 11
4.1 Withstanding test.....	p. 11
4.2 Withstanding test with preset voltage/time diagram.....	p. 14
4.3 Low resistance test with current of > 0.1A / 0.2A / 10A / 25A~.....	p. 16
4.4 Voltage drop scaled to test current of 10A~.....	p. 17
4.5 Insulation resistance.....	p. 18
4.6 Discharge time - external (input MAINS TEST).....	p. 20
4.7 Discharge time - internal.....	p. 21
4.8 Leakage current.....	p. 22
4.8.1 Leakage current.....	p. 22
4.8.2 Touch Leakage current.....	p. 23
4.8.3 Substitute Leakage current.....	p. 24
4.9 Functional test.....	p. 25
4.10 Autotest.....	p. 26
5. OPERATION.....	p. 30
5.1 Warnings.....	p. 30
5.2 Results memorizing.....	p. 31
5.3 Recalling of stored results.....	p. 32
5.4 RS 232 Communication.....	p. 32
5.5 System configuration.....	p. 33
5.6 Contrast of the display.....	p. 36
5.7 Use of remote control pedal.....	p. 36
5.8 Use of WRANING LAMP.....	p. 37
5.9 Use of barcode reader.....	p. 38
5.10 Use of EXT / DOOR input.....	p. 38
5.10.1 DOOR input.....	p. 38
5.10.2 EXTERNAL input.....	p. 38
6. MAINTENANCE.....	p. 40
6.1 Metrological check.....	p. 40
6.2 Service.....	p. 40
6.3 Cleaning.....	p. 40
6.4 Replacing the fuses (by properly trained service personnel only!).....	p. 40
6.5 Replacing the battery (by properly trained service personnel only!).....	p. 40
6.6 Repairs.....	p. 40
7. PC SOFTWARE - CE LINK.....	p. 41
7.1 Installing CE Link.....	p. 41
7.2 Introduction notes.....	p. 41
7.3 Download data.....	p. 42
7.4 Open data file.....	p. 44
7.5 Printing documents.....	p. 47
7.5.1 Printing selected rows.....	p. 47
7.5.2 Print separately.....	p. 48
7.6 Header programming.....	p. 49
7.7 Sequence editor.....	p. 50
8. TO ORDER.....	p. 54

1. GENERAL PRESENTATION

1.1 SAFETY IN USE

- Use the instrument in accordance with the manual, otherwise the instrument may be dangerous for the operator!
- Read this instruction manual carefully, otherwise use of the instrument may be dangerous for the operator, for the instrument or for equipment under test!
- Use only grounded mains outlets to supply the instrument!
- Do not use any damaged mains outlet or damaged mains connection cable!
- Service or calibration procedure must only be carried out by a competent authorized person!
- Only a skilled person, who is familiar with hazardous voltage operations, can handle APPLIANCE MULTITESTER!

Meaning of ,  signs on front panel :

Insulation section



Dangerous voltage may be present; measurements shall be carried out only on de-energized object.

Continuity section



Read instructions on how to replace blown-up fuse, measurements shall be carried out only on de-energized object.

Withstanding section

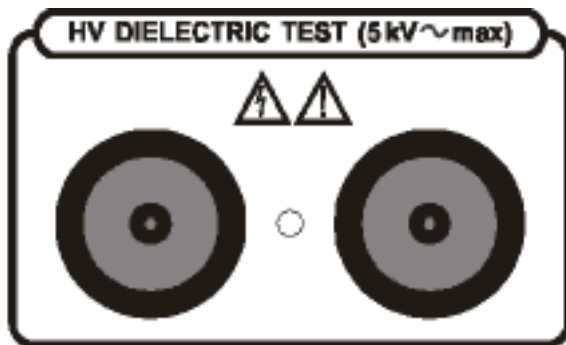

Dangerous voltage may be present, switch off the instrument immediately if the red warning lamp (pos. 12, fig. 1) does not light after switching on HV generator, and service the instrument. Always handle as the test leads are energized.

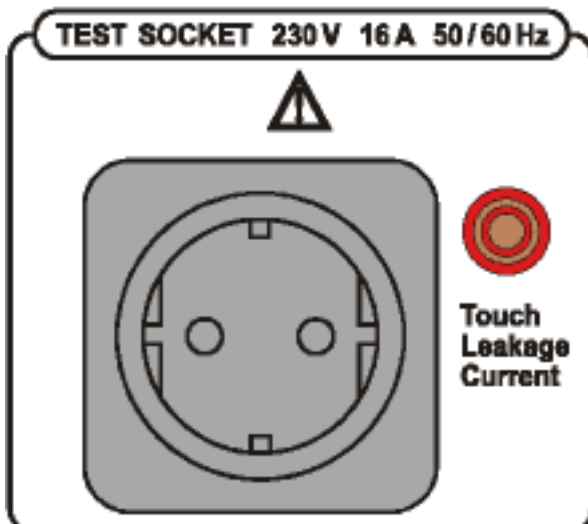

Dangerous voltage is present during Leakage, Substitute leakage and Functional test. Measurements shall be carried out only on de-energized object.

Main plug

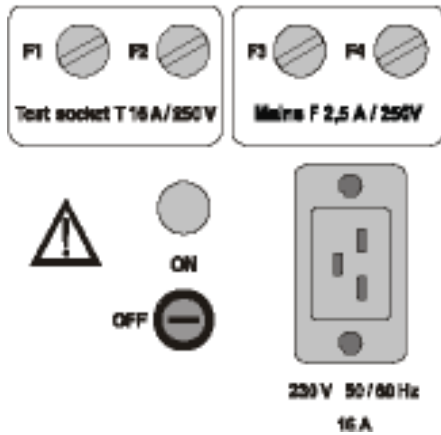

Dangerous voltage is present on the FUSES - switch off the instrument and disconnect all test cables and mains cord before replacing the fuses or opening the instrument.

1.2 WARRANTY

Unless stated differently, our instruments are guaranteed against any manufacturing or material defect. They do not bear the specification known as the safety specification. Our guarantee, which may not under any circumstances exceed the amount of the invoiced price, is for the repair of our faulty equipment only, carriage paid to our workshops. It is applicable for normal use of our instruments and does not apply to any damage or destruction caused, notably by error in mounting, mechanical accident, faulty maintenance, defective use, overload or excess voltage.

Our responsibility is strictly limited to the pure and simple replacement of the faulty parts of our equipment; the buyer expressly renounces any attempt to find us responsible for damages or losses caused directly or indirectly.

Our guarantee is applicable for twelve (12) months after the date at which the equipment is made available. The repair, modification or replacement of a part during the guarantee period will not result in this guarantee being extended.

1.3 LIST OF MEASUREMENTS CARRIED OUT BY THE INSTRUMENT

- Withstanding programmed voltage - time sequence test
- Withstanding voltage test
- High voltage burn-out test
- Continuity test
- Voltage drop test
- Insulation resistance test
- Leakage current tests (leakage, substitute, touch)
- Functional tests (power, voltage, current, $\cos \varphi$, frequency)
- Discharge time measurement

1.4 LIST OF APPLICABLE STANDARDS

C.A APPLIANCE MULTITESTER is designed in accordance with the following standards:

- EN 61010-1 safety
- EN 61326-1 electromagnetic compatibility

Measurements in compliance with:

- IEC 60204-1 Electrical equipment of machines
- IEC 60335-1 Household and similar electrical appliances
- IEC 60439-1 Switch-gear and control-gear assemblies
- IEC 60598-1 Luminaries
- IEC 60745 Hand-held motor-operated tools
- IEC 60755 Residual current operated protect. devices
- IEC 60950 Safety of information technology equipment
- IEC 61010-1 Safety requirements for electrical equipment
- IEC 61029 Transportable motor-operated tools
- IEC 61558-1 Transformers and power supply units
- EN 60065 Audio, video, and similar electronic apparatus
- VDE 701 T1 Repair and modification inspections
- VDE 702 T1 Repeat tests of electrical appliances

The APPLIANCE MULTITESTER instrument supply upper standards up to 16A according to its maximum power capability.



The rubbish bin with a line through it indicates that, in the European Union, the product must undergo selective disposal in compliance with Directive WEEE 2002/96/EC. This equipment must not be treated as household waste.

2. DESCRIPTION OF THE INSTRUMENT

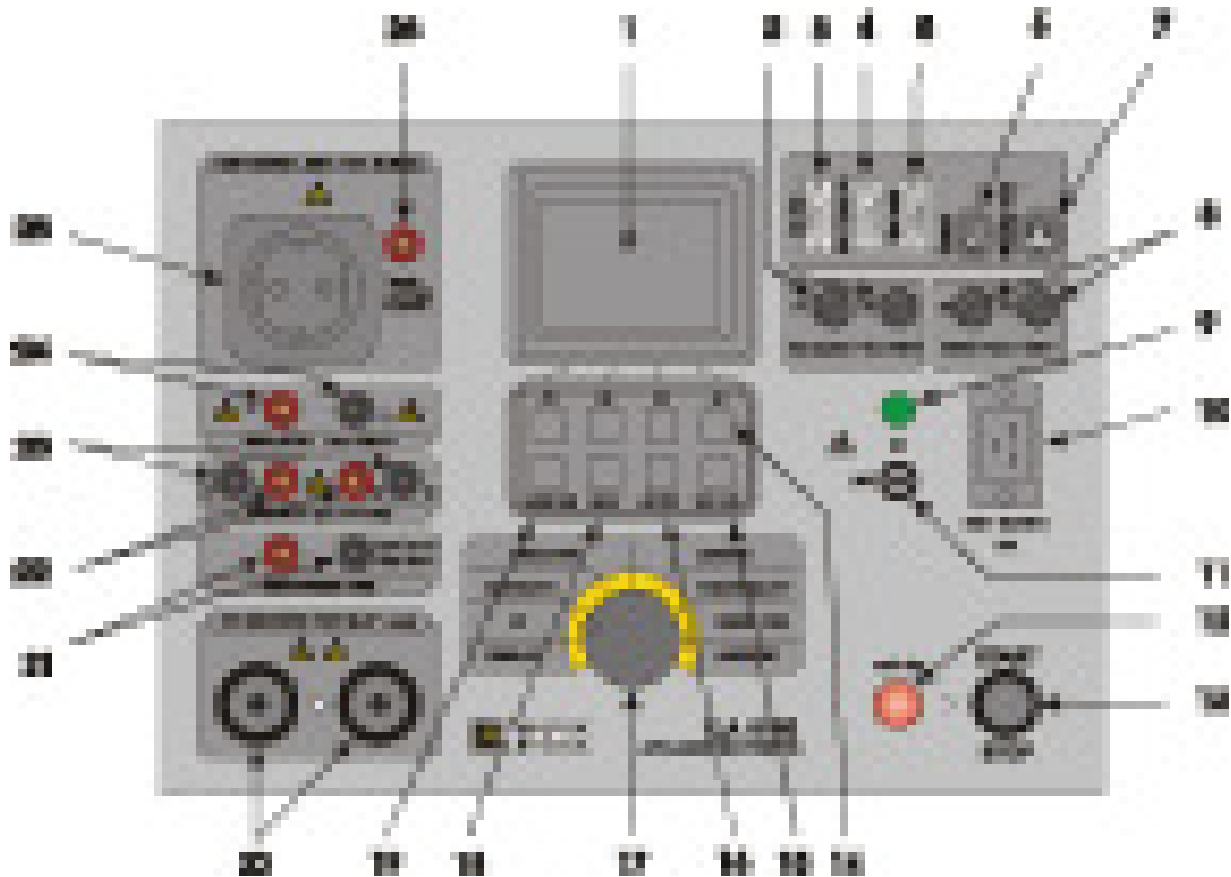

Fig.1. Front panel layout

Legend:

- 1 LCD dot matrix display with continuous backlight
- 2 T16A 250V 6.3x32 fuses protect test socket from overloading
- 3 RS 232 connector to connect external printer or PC
- 4 EXT/DOOR IN connector
- 5 BAR CODE READER connector
- 6 REMOTE connector to connect REMOTE CONTROL PEDAL
- 7 WARNING LAMP connector to connect WARNING LAMP
- 8 F 2.5A 250V fuses protect instrument's power supply
- 9 POWER ON/OFF indication lamp
- 10 Mains connector
- 11 POWER ON/OFF switch with key protection
- 12 TEST ON warning lamp
- 13 START/STOP push button
- 14 General keys F1 to F4 (function of each key is shown on display)
- 15 SET key (press when the instrument is switched ON):
 - Set date / time
 - Set serial port baud rate
 - Set barcode reader baud rate
 - Clear records memory
 - Clear devices / records
 - Clear program memory
 - Load default setting
 - INPUT DOOR IN disabled / enabled
- 16 RS232 key:
 - Select RS 232 communication mode
 - Transmit memorized data to PC
- 17 ROTARY SWITCH to select desired function
- 18 HELP key:
- 19 MEM key:
 - Memorize results
 - Recall memorized results
- 20 WITHSTANDING test terminals
- 21 DISCHARGE TIME test terminals
- 22 CONTINUITY current test terminals
- 23 CONTINUITY potential test terminals
- 24 INSULATION test terminals
- 25 TEST SOCKET 230V /16 A
- 26 TOUCH leakage test terminal

3. TECHNICAL SPECIFICATIONS

3.1 WITHSTANDING TEST (PROG. HV AND HV POSITION)

Nominal test voltage : adjustable (100/5000) V (50,60) Hz at $U_{\text{mains}} = 230\text{V}$, $P_{\text{load}} = 500\text{VA}$
 Open circuit test voltage : U_n (nominal test voltage) (-1% / +10%) at $U_{\text{mains}} = 230\text{V}$
 Output differential : 2HV plugs
 Voltage shape: sinusoidal

Test voltage readout

Range (kV)	Resolution (kV)	Accuracy
0.100 - 0.999	0.001	$\pm(2\% \text{ of reading} + 5 \text{ dig.})$
1.000 - 5.000	0.001	$\pm(3\% \text{ of reading} + 5 \text{ dig.})$

Two different voltage procedure modes :

- Standard voltage mode
- Programmable voltage mode (parameters t_1, t_2, t_3, U_1, U_2)

Trip-out out test current for nominal test voltages up to 1000 V adjustable to 0.5, 1.0, 1.5 2.0, 2.5, 3.0, 3.5, 4.0, 4.5, 5.0, 5.5, 6.0, 6.5, 7.0, 7.5, 8.0, 8.5, 9.0, 9.5, 10, 20, 30, 40, 50, 60, 70, 80, 90, 100, 150, 200, 250, 300, 350, 400, 450, 500 mA.

For test voltages greater than 1000 V, maximum current limit depends on max high voltage power characteristic (500 VA = max power).

Accuracy of trip-out test current: $\pm 10\%$ of set value.

Test current readout (sin wave)

Range (mA)	Resolution (mA)	Accuracy
0.0 - 500.0	0.1	$\pm(5\% \text{ of reading} + 5 \text{ digit})$ absolute value
0.0 - 500.0	0.1	$\pm(30\% \text{ of reading} + 10 \text{ digit})$ resistive or capacitive value**

** not displayed at 'Trip out' STOP

Absolute value of test current is always displayed ($I_A = \sqrt{I_R^2 + I_C^2}$) together with selected resistive (\square) or capacitive (\square) component.

Trip out time: < 30 ms after break through.

Timer: adjustable 1 s - 9 min 59 s with resolution of 1 s. Timer OFF function available.

3.2. BURN OUT (HV POSITION)

Selectable voltage : (100 - 5000) V
 Minimum burnout time before overheating: 10 s
 I max.: (50 - 60) mA

3.3. LOW RESISTANCE (CONTINUITY POSITION)

Resistance readout for current 10 A and 25 A

Range R (Ω) [*]	Resolution (Ω)	Accuracy
0.000 - 0.999	0.001	$\pm(3\% \text{ of reading} + 3 \text{ dig.})$
1.000 - 2.000	0.001	$\pm(3\% \text{ of reading} + 10 \text{ dig.})$
2.001 - 9.999	0.001	indicator only

* autoranging

Resistance readout for current 0.10 A

Range R (Ω) [*]	Resolution (Ω)	Accuracy
0.00- 9.99	0.01	$\pm(5\% \text{ of reading} + 12 \text{ dig.})$
10.0- 100.0	0.1	$\pm(5\% \text{ of reading} + 6 \text{ dig.})$

* autoranging

Resistance readout for current 0.20 A

Range R (Ω) [*]	Resolution (Ω)	Accuracy
0.00 - 9.99	0.01	$\pm(5\% \text{ of reading} + 6 \text{ dig.})$
10.0- 100.0	0.1	$\pm(5\% \text{ of reading} + 6 \text{ dig.})$

* autoranging

Max. output voltage: <6 V~

Measuring curr. (electronically stabilized). selectable 100 mA, 200 mA, 10 A, 25 A

- 10 mA at R < 50 Ω (U_{mains} : 230 V, original test leads)

- 200 mA at R < 8 Ω (U_{mains} : 230 V, original test leads)

- 10 A at R < 0.5 Ω (U_{mains} : 230 V, original test leads)

- 25 A at R < 0.2 Ω (U_{mains} : 230 V, original test leads)

Current shape: sinusoidal

Threshold value adjustable: 10 m Ω - 1.0 Ω (in steps of 10 m Ω),

1.0 Ω - 2.0 Ω (in steps of 100 m Ω),

or ignored (** Ω sign is selected)

Timer: adjustable 1 s - 59 s, resolution 1 s

Connection system: 4 wire, safety connectors, electrically separated

Test voltage readout with current 10A and 25A

Range (V)	Resolution (V)	Accuracy
0.000 – 10.000	0.001	$\pm(3\% \text{ of reading} + 0.05 \text{ V})$

Test voltage readout with current 0.1 A and 0.2 A

Range (V)	Resolution (V)	Accuracy
0.000 – 10.000	0.001	$\pm(5\% \text{ of reading} + 0.1 \text{ V})$

Test current readout 10 A and 25 A

Range (A)	Resolution (A)	Accuracy
0.0 – 30.0	0.1	$\pm(3\% \text{ of reading} + 5 \text{ dig.})$

Test current readout 0.1A and 0.2A

Range (A)	Resolution (A)	Accuracy
0.000 – 1.000	0.001	$\pm(5\% \text{ of reading} + 5 \text{ dig.})$

3.4. VOLTAGE DROP SCALED TO 10 A~ (OPTION IN CONTINUITY POSITION)

Voltage drop readout (scaled to 10A~)

Range ΔU (V)	Resolution (V)	Accuracy
0.00 – 10.00	0.01	$\pm(3\% \text{ of reading} + 3 \text{ dig.})$
10.00 – 99.99	0.01	indicator only

Test current readout

Range (A)	Resolution (A)	Accuracy
0.0 – 30.0	0.1	$\pm(3\% \text{ of reading} + 3 \text{ dig.})$

Threshold value of voltage drop versus wire section:

Wire section (mm^2)	Threshold voltage drop (V)
0.5	5.0
0.75	5.0
1	3.3
1.5	2.6
2.5	1.9
4	1.4
≥ 6	1.0

Any of the wire sections in the previous table can be selected in order to evaluate voltage drop result.

Max. output voltage: 10 V~
 Electronically stabilized current
 Current shape: sinusoidal
 Measuring current (external resist. of (0 - 0.5) Ω connected to original test cable : >10 A~
 Timer: adjustable (1 - 59) s, resolution 1 s
 Connection system: 4 wire, safety connectors, electrically separated

3.5. INSULATION RESISTANCE

■ Nominal voltage 250 V, 500 V, 1000 V \equiv

Insulation resistance readout:

Range* (M Ω)	Resolution ** (M Ω)	Accuracy
0.000 - 1.999	0.001	$\pm(5\% \text{ of reading} + 10 \text{ dig.})$
2.000 – 199.9	0.001, 0.01, 0.1	$\pm(3\% \text{ of reading} + 3 \text{ dig.})$
200 - 999	1	$\pm(10\% \text{ of reading} + 10 \text{ dig.})$

* autoranging, depends on test voltage

** depends on test voltage

Measuring range (stable and accurate result even with capacitive load):
 typ. @ 250 V 5 μF // 1.4 M Ω ; @ 500 V & 1000V 5 μF // 4.2 M Ω

Nominal voltage: (250, 500, 1000) V \equiv (+30 % / - 0 %)

Short circuit current: 3.5 mA max.

Measuring current: 1 mA min. at (250, 500, 1000) k Ω load

Settable limits: (0.2 - 200.0) M Ω (resolution 0.1 M Ω), no limit
 (** M Ω sign is selected)

Timer: adjustable 1 s - 9 min 59 s with resolution of 1 s

Timer OFF function available.

Subresult: measuring voltage

Output: 2 safety plugs, grounded

Auto-discharge after test.

3.6. LEAKAGE CURRENT

3.6.1. LEAKAGE CURRENT

Leakage current readout:

Range (mA)	Resolution (mA)	Accuracy
0.00 – 3.99	0.01	±(5 % of reading + 3 dig.)
4.0 – 20.0	0.1	±(5 % of reading + 3 dig.)

Settable limits: (0.1 – 20.0) mA (in step of 0.1 mA)
 Output: 16 A power test socket
 Timer: adjustable 1 s - 9 min 59 s with resolution 1 s
 Timer OFF function available.

3.6.2. TOUCH LEAKAGE CURRENT

Touch leakage current readout:

Range (mA)	Resolution (mA)	Accuracy
0.00 – 2.00	0.01	±(5% of reading + 3digit)

Settable limits:..... (0.1 – 2.0) mA (in step of 0.1 mA)
 Output:16 A power test socket + TOUCH safety plug
 $R_{\text{Ameter}}: 2 \text{ k}\Omega$

3.6.3. SUBSTITUTE LEAKAGE CURRENT

Substitute leakage current readout:

Range (mA)	Resolution (mA)	Accuracy
0.00 – 20.0	0.01	±(5% of reading + 3digit)

Settable limits: (0.1 – 20.0) mA (in step of 0.1 mA)
 Short circuit current:..... < 30 mA
 Open circuit voltage :..... 40 V
 Output:16 A power test socket
 Displayed current is calculated to 230 V

3.7. FUNCTIONAL TEST

Active Power, Apparent Power, Voltage, Current and Frequency monitoring on the test socket :
 Active Power, Apparent Power

Range (W)	Resolution (W)	Accuracy
0 – 199.9	0.1	±(5 % of reading + 10 digit)
200 – 3500	1	±(5 % of reading + 3 digit)

Test voltage readout

Range (V)	Resolution (V)	Accuracy
0 – 400 V	1	±(2 % of reading + 2 digit)

Test current readout

Range (A)	Resolution (A)	Accuracy
0 – 0.999	0.001	±(3 % of reading + 5 dig.)
1.00 – 15.99	0.01	±(5 % of reading + 5 dig.)

Cos φ readout

Range	Resolution	Accuracy
0 – 1.00	0.01	±(3 % of reading + 3 dig.)

Frequency readout

Range (Hz)	Resolution (Hz)	Accuracy
45.00 – 65.00	0.01	±(0.1% of reading +3 dig.)

Threshold Apparent Power: adjustable (10 - 3500) VA
 (10 - 100) VA (resolution 1 VA)
 (100 - 3500) VA (resolution 10 VA)
 Output: 16 A power test socket
 Timer: adjustable 1 s - 9 min 59 s with resolution 1 s
 Timer OFF function available.

3.8. DISCHARGE TIME (DISC.TIME POSITION)

■ **Discharge time on power plug (external)**

Max. working voltage 600 V p
 Min. working voltage (60, 120) V p
 Measuring range (0 - 10) s
 Resolution 0.1 s
 Threshold of discharging time 1 s
 Accuracy ±(2 % of reading + 0.2 s)
 Safe voltage level 60 V, 120 V
 Internal resistance of input 96 MΩ

■ **Discharge time on internal electronic components (internal)**

Max. working voltage 600 V p
 Min. working voltage (60,120) V p
 Measuring range (0 - 10) s
 Resolution 0.1 s
 Threshold of discharging time 5 s
 Accuracy ±(2% of reading + 0.2 s)
 Safe voltage level 60 V, 120 V
 Internal resistance of input 96 MΩ

3.9. GENERAL

Mains voltage: 230 V (-10 % - +6 %) / (50,60) Hz
 Max. power consumption: 660 VA (without load on TEST SOCKET)
 Display: LCD dot matrix, (160 x 116) dots with cont. backlight
 RS232 interface: 1 start bit, 8 data bits, 1 stop bit
 RS232 baud rate adjustable: 9600, 19200, 38400 Baud
 Memories: 1638 memory locations
 Remote control signals: START / STOP, SAVE
 EXT/ Door in signals: Next test, Good / Bad result, External input, Door in
 Bar code reader: EAN13
 Bar code baud rate adjustable: 2400, 4800 or 9600 Baud
 Measurement circuitry protection:
 F3 F 2.5 A / 250 V (5 × 20) mm (general protection of the instrument)
 F4 F 2.5 A / 250 V (5 × 20) mm (general protection of the instrument)

NOTE !

For correct operation of the instrument fuses F3 and F4 must be in good condition because the test socket is the point from which the instrument observes the input voltage (zero crossing for soft start of internal generator).

Case: shock proof plastic / portable
 Dimensions (w × h × d): (410 × 175 × 370) mm
 Mass (without accessories): 13.5 kg
 Pollution degree: 2
 Degree of protection (at closed cover): IP 50
 Overvoltage category: Cat III / 300V, Cat II / 600V
 Protection classification: I
 Working temp. range: (0 - +40) °C
 Ref. temp. range: (+5 - +35) °C
 Ref. humidity range: (+40 - +70) % RH
 Storage temp. range: (-10 - +60) °C
 Max. working humidity: 85% RH (0 - +40) °C
 Max. storage humidity: 90% RH (-10 - +40) °C
 80% RH (+40 - +60) °C

Accuracies apply for 1 year in reference conditions. Temperature coefficient outside this limits is 0.1% of measured value per °C and 1 digit.

Withstanding proof test:

- Between mains and withstanding terminals 7500 Veff / 1 min
- Between mains and other terminals or accessible metallic parts 2200 Veff / 1 min

4. MEASUREMENTS

4.1. WITHSTANDING TEST:

WARNING !

- **Only a skilled person, who is familiar with hazardous voltage operations, can perform this measurement!**
 - **Check instrument and test leads for any sign of damage or abnormality before connecting them to the instrument. DO NOT use test probes in case of any damage or abnormality!**
 - **Always handle the instrument and connected accessories as the Withstanding test sockets and leads are under the hazardous voltage!**
 - **Never touch exposed probe tip, connected equipment under test or any other energized part during the measurements. Make sure that NOBODY can contact them either!**
 - **Connect test probes only for withstanding measurement, and disconnect them immediately after the test!**
 - **DO NOT touch any part of test probe in front of the barrier (keep your fingers behind the finger guards on the probe) – possible danger of electric shock!**
- Always set the lowest possible trip-out current.**

HV (high voltage) position

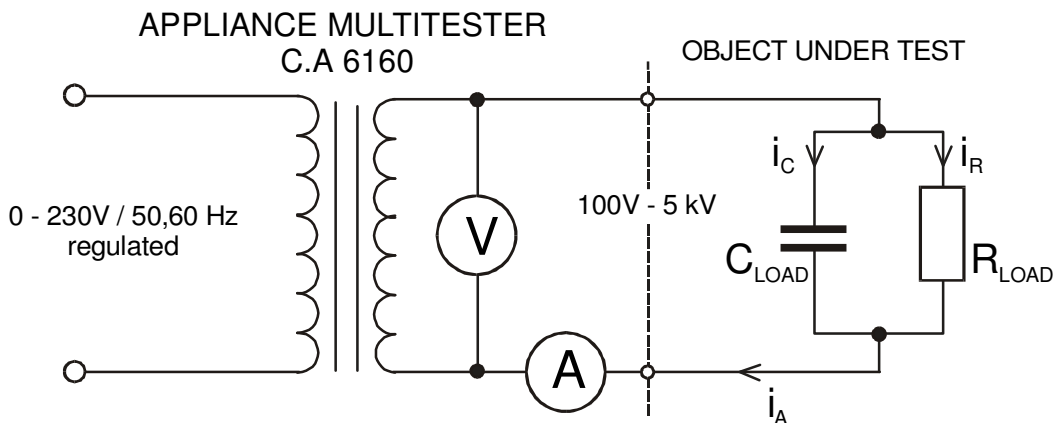

Fig. 2. Test circuitry

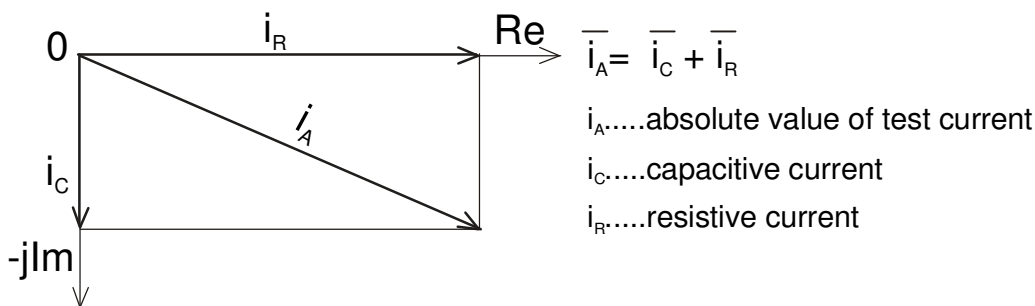

Fig. 3. Test current diagram

How to carry out the measurement

STEP 1. Set rotary switch to HV (high voltage) position. The following heading is displayed:

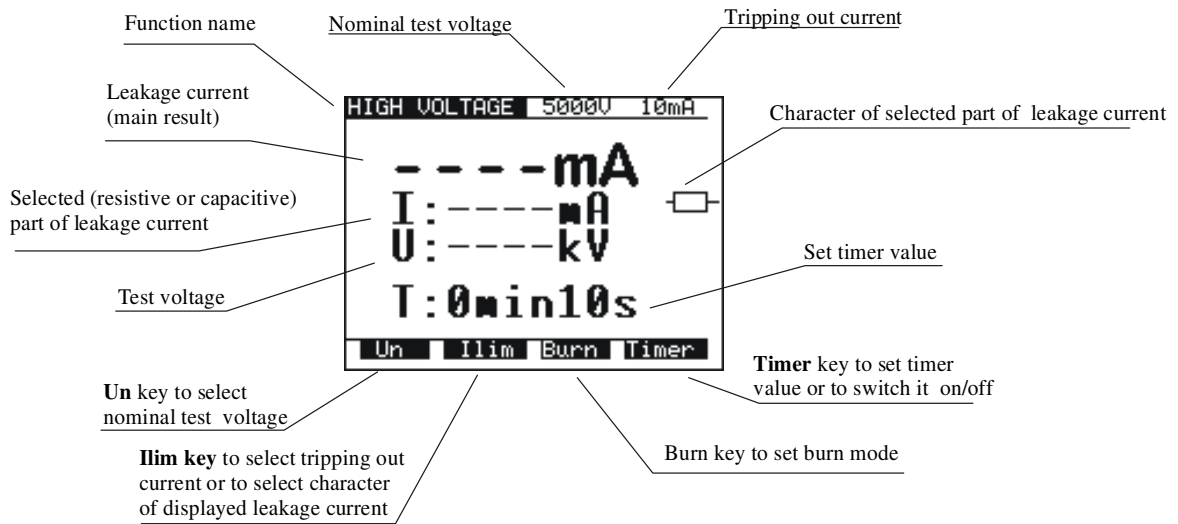

Fig. 4. Main menu in HV function

STEP 2. Select test parameters as follows:

- Test voltage
 - Use **U_N** key to select appropriate test voltage that can be set using ↑↓ keys from 100 V to 1000 V in 10 V steps and from 1000 V to 5000 V in 50 V steps.

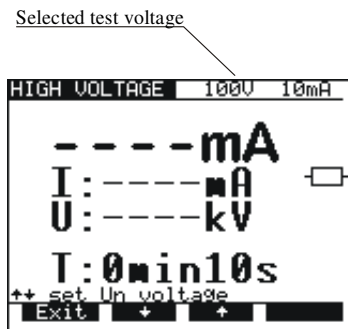

Fig. 5. Test voltage selection menu

- Press **Exit** key to exit Test voltage selection menu.
- Trip-out current / character of displayed part of leakage current
 - Press **Ilim** key in order to reach menu for trip-out current selection and character of displayed part of leakage current (resistive or capacitive). See the following figure.

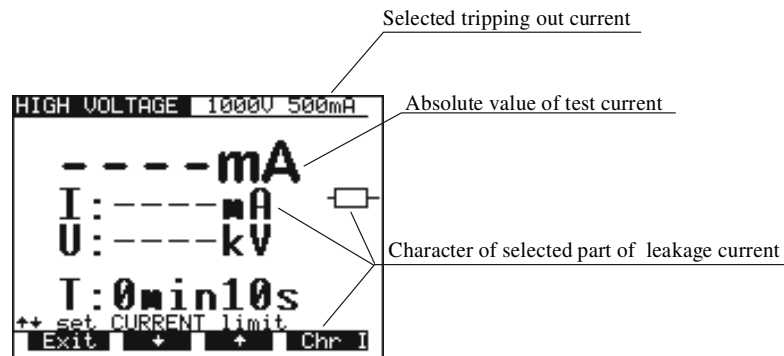



Fig. 6. Trip-out current selection menu

- Use ↑ and ↓ keys to select appropriate trip-out current.
- Press **Chr I** in order to change the character of displayed part of leakage current. If the selected part is resistive,  sign is displayed behind mA unit. For capacitive part  sign is displayed behind mA unit.
- Press **Exit** key to exit Trip-out current selection menu.

NOTE !

The set threshold value of test current is always compared with the absolute value of test current.

■ Timer value / timer OFF/ON

- Press **Timer** key and the menu for timer value selection is displayed.
- Use ↑ and ↓ keys to select appropriate test time value.
- To deactivate the timer press **Toff** key or **Ton** key to activate it. See the following figure.

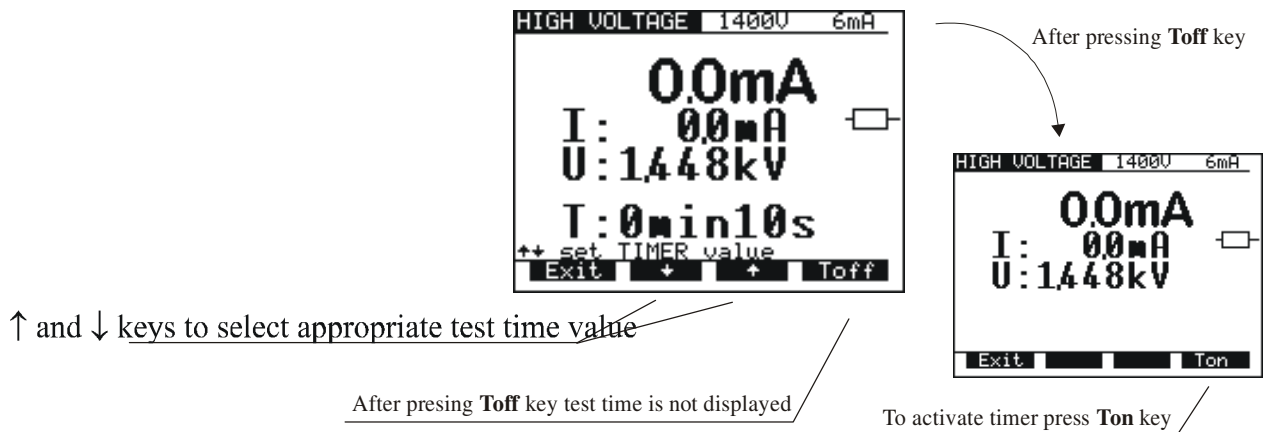

Fig. 7. Timer value selection menu

- Press **Exit** key to exit Timer value selection menu.

■ BURN mode

- Press **Burn** key to select Burn out mode. In this mode current is limited only by the internal generator characteristics.

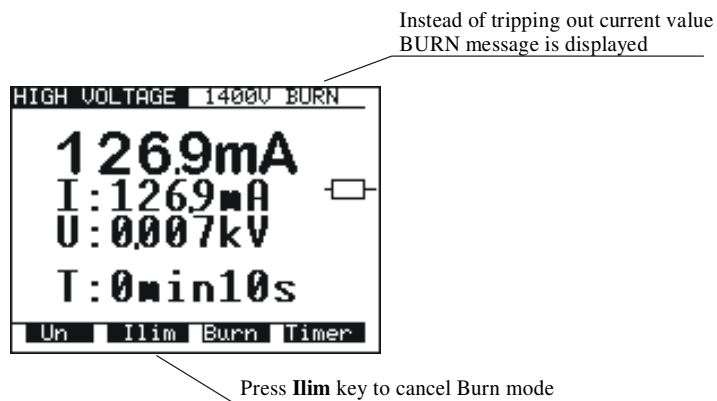

Fig. 8. Main menu in HV function when the BURN mode is selected

NOTE !

The result of BURN test cannot be saved

STEP 3. Connect test probes (pistols) to the instrument as shown in figure below.

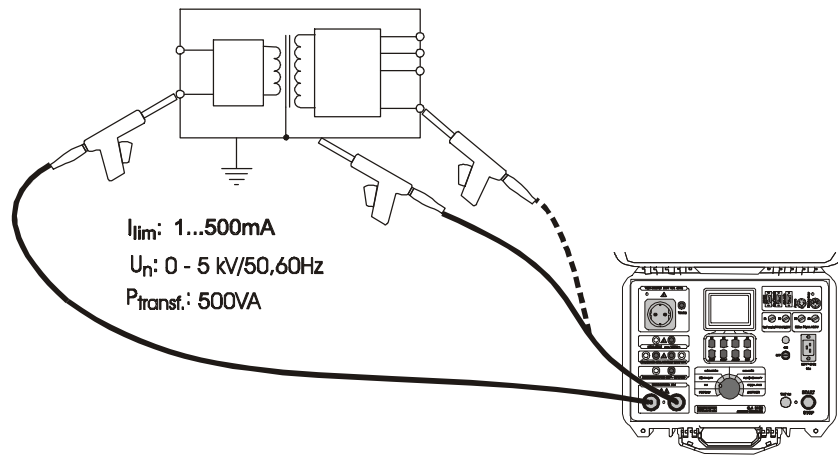

Fig. 9. Connection of test probes

STEP 4. Close **DOOR IN** safety connector, if enabled. (CONTINUITY test terminals must be open).

STEP 5. Press **START/STOP** key to start high voltage generator and carry out the test using test probes.

STEP 6. Wait for the test time to elapse (if the timer has been switched on) or press **START/STOP** key again to stop high voltage generator.

NOTES !

- Take care when using HV test pistols - hazardous voltage!
- Use timer ON mode or optional REMOTE CONTROL pedal to stop the measurement when test probes are still connected to equipment under test. The displayed result obtained in this way can be stored to memory for documentation purposes.
- It is advisable to connect test pistols to the equipment under test before pressing START/STOP pedal to avoid sparking and trip out of the HV generator.
- It is advisable to use the optional WARNING LAMP connected to the instrument, especially if the measurements are to be done away from the instrument using optional test probes with longer cables.
- If there is a test current higher than the preset limit, HV generator trips automatically after reaching that value. Preset limit value is displayed as a result in this instance.

STEP 7. Save displayed result for documentation purpose (see instruction in chapter 5.2. on how to save displayed result).

4.2. WITHSTANDING TEST WITH PRESET VOLTAGE/TIME DIAGRAM:

WARNING !

- *Only a skilled person, who is familiar with hazardous voltage operations, can perform this measurement!*
 - *Check instrument and test leads for any sign of damage or abnormality before connecting them to the instrument. DO NOT use test probes in case of any damage or abnormality!*
 - *Always handle the instrument and connected accessories as the Withstanding test sockets and leads are under the hazardous voltage!*
 - *Never touch exposed probe tip, connected equipment under test or any other energized part during the measurements. Make sure that NOBODY can contact them either!*
 - *Connect test probes only for withstanding measurement, and disconnect them immediately after the test!*
 - *DO NOT touch any part of test probe in front of the barrier (keep your fingers behind the finger guards on the probe) – possible danger of electric shock!*
- Always set the lowest possible trip-out current.*

PROG.HV (programmed HV) position

How to carry out the measurement

STEP 1. Set rotary switch to **PROG.HV** (high voltage) position, the following heading is displayed:

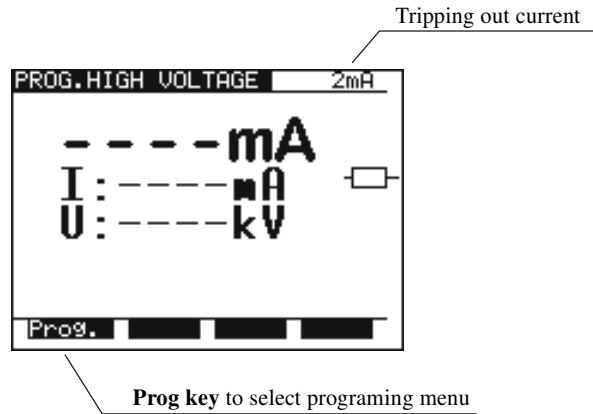

Fig. 10. Main menu in PROG.HV function

STEP 2. Press **Prog.** key to set or to check programmed ramp values in order to prevent damage to the equipment under test (last values used are memorized). Select test parameters as follows:

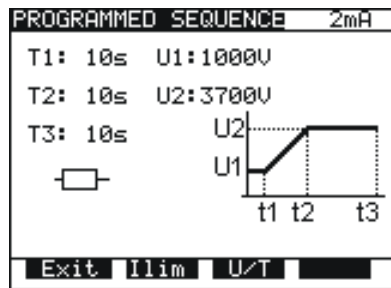

Fig. 11. Menu for programming ramp values

■ Press **Ilim** key in order to reach menu for trip-out current selection and character of displayed part of leakage current (resistive or capacitive). The same procedure as for Ilim selection at HV function applies.

To change U and T values press **U/T** key. Value **T2** represent time from **t1** to **t2** and value **T3** represent time from **t2** to **t3**. (fig. 12). Menu for selection and changing values is displayed, see the following figure:

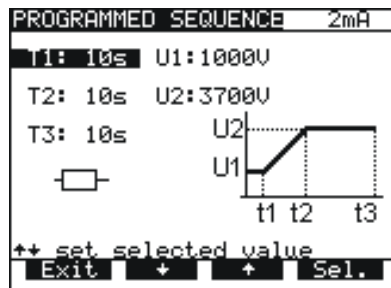

Fig. 12. Timer T1 is selected, change value by using $\uparrow \downarrow$ keys

- To select ramp times or voltage values press **Sel.** key.
- Use \uparrow and \downarrow keys to set appropriate test value:
- Time: (1 s - 240 s)
- Voltage: 100 V –5 kV
- Press **Exit** key (2x) to exit.

STEP 3. Connect test probes (pistols) to the instrument.

STEP 4. Close **DOOR IN** safety connector, if enabled. (CONTINUITY test terminals must be open).

STEP 5. Press **START/STOP** key to start high voltage generator and carry out the test using test probes.

STEP 6. Wait for the test time to elapse or press **START/STOP** key again to stop high voltage generator.

STEP 7. Save displayed result for documentation purpose (see instruction in chapter 5.2. on how to save displayed result).

4.3. LOW RESISTANCE TEST WITH CURRENT OF >0.1A / 0.2A / 10A / 25A~

CONTINUITY position

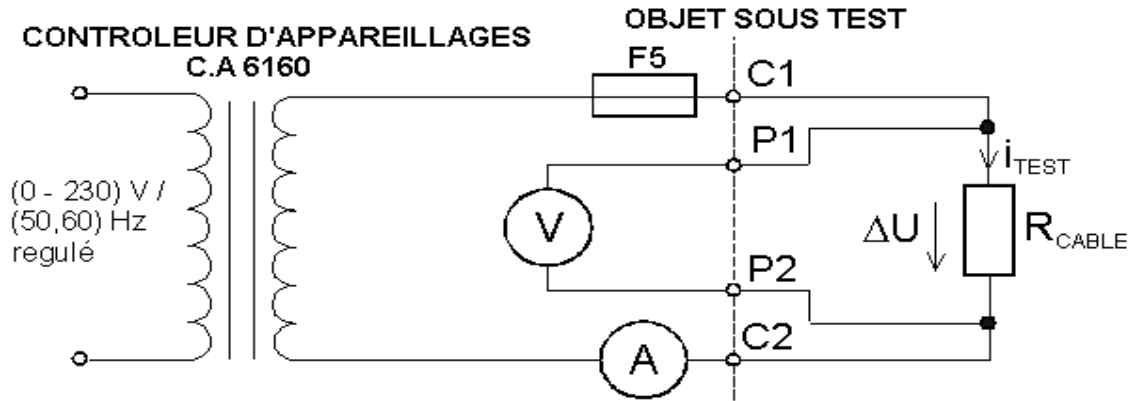

Fig. 13. Test circuitry

How to carry out the measurement

STEP 1. Set rotary switch to **Continuity** position. The following heading is displayed.

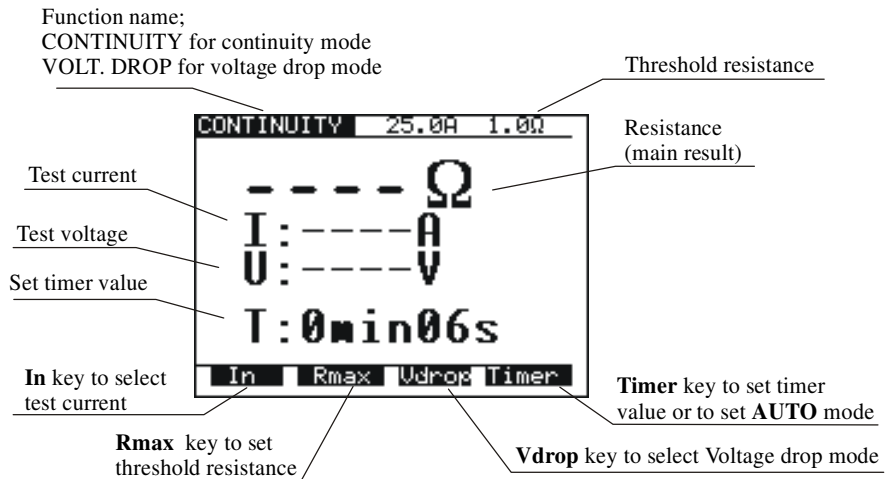

Fig. 14. Main menu in Continuity function

STEP 2. Select test parameters as follows:

- Measurement current
 - Use **In** key to select appropriate measurement current.
- Resistance threshold
 - Press **R_{max}** key in order to reach the menu for selection of resistance threshold (see the following figure).

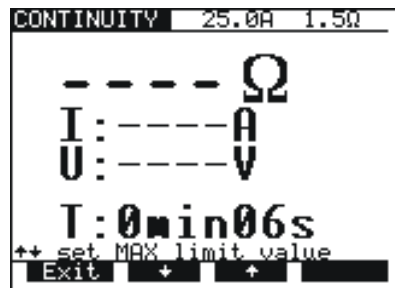

Fig. 15. Low resistance threshold selection menu

- Use \uparrow and \downarrow keys to select appropriate threshold value. If the displayed result is higher than the set threshold limit, the result will be accompanied by an error sound signal (after completion of the measurement). No threshold value will be selected and no sound signal will be activated when « *** Ω » is selected instead of threshold limit.
- Press **Exit** key to exit **Low resistance threshold** selection menu.

■ Timer value + AUTO start option

- Press **Timer** key and the menu for selection of timer value is displayed.

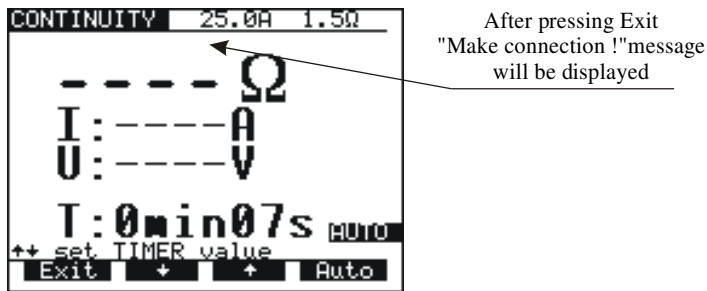

Fig.16. Timer value selection menu with auto option

- Use \uparrow and \downarrow keys to select appropriate test time value.
- To activate the measurement automatically when the instrument is connected to the equipment under test press the **Auto** key. In this mode a small voltage value is always present on the continuity test terminals. The flow of a small current across the tested item when the test terminals are connected will activate the measurement. By turning the ROTARY SWITCH or switching off the instrument the AUTO function is automatically disabled.

STEP 3. Connect test probes to the instrument and to the tested item as shown in the figure below.

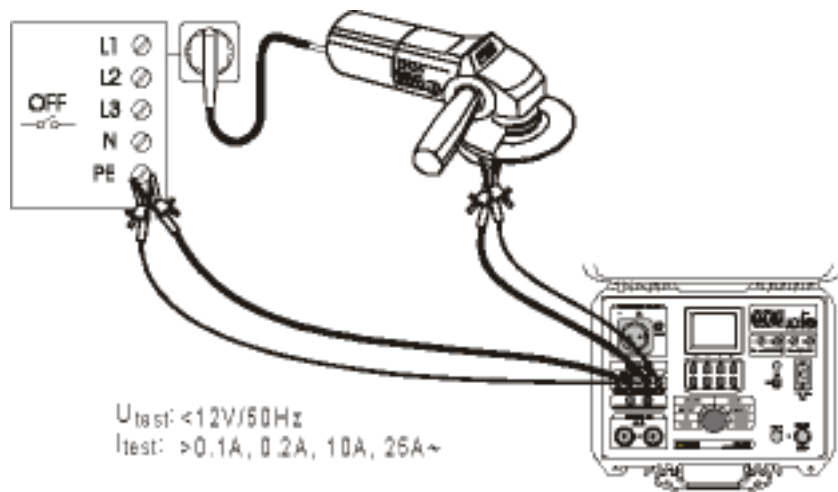

Fig. 17. Connection of test leads

STEP 4. Press **START/STOP** key to start the measurement.

STEP 5. Wait for the set time to elapse or press **START/STOP** key again to stop the measurement.

STEP 6. Save displayed result for documentation purpose (see instruction in chapter 5.2. on how to save displayed result).

NOTE !

Test results can be adversely affected by impedances of additional operating circuits connected in parallel with the tested device or by transient currents.

4.4. VOLTAGE DROP SCALED TO TEST CURRENT OF 10 A~

CONTINUITY position

How to carry out the measurement

STEP 1. Set rotary switch to **CONTINUITY** position, press **Vdrop** key. The following heading is displayed.

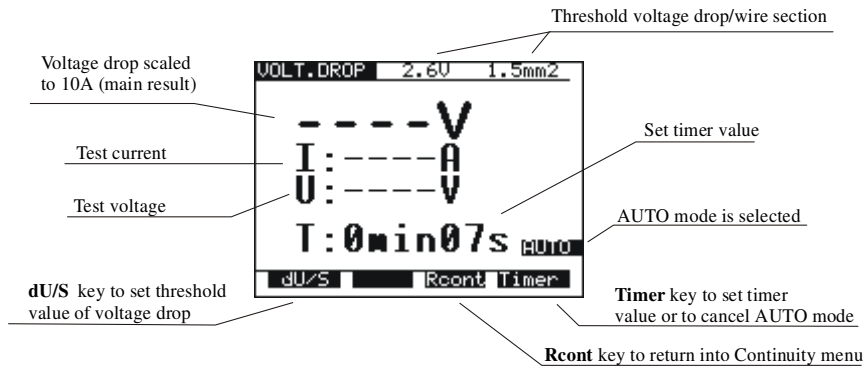

Fig. 18. Main menu in Voltage drop function

STEP 2. Select test parameters as follows:

- Voltage drop threshold.
- Use **dU/S** key to select appropriate threshold, see the table in paragr. 3.4.
 - Timer value + AUTO start option
 - See instructions in paragraph 4.3.

STEP 3. Connect test probes to the instrument and to equipment under test as shown in the following figure:

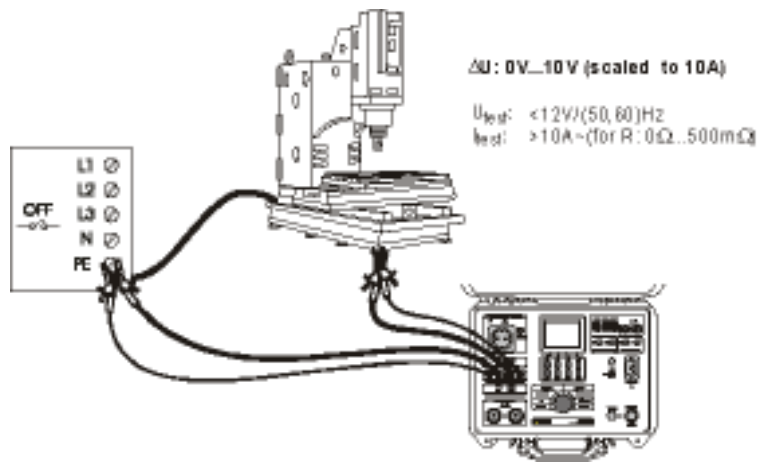

Fig. 19. Connection of test leads

STEP 4. Press **START/STOP** key to start the measurement.

STEP 5. Wait for the set time to elapse or press **START/STOP** key again to stop the measurement.

STEP 6. Save displayed result for documentation purpose (see instruction in chapter 5.2. on how to save displayed result).

NOTE !

Test results can be adversely affected by impedances of additional operating circuits connected in parallel with the tested device or by transient currents.

4.5. INSULATION RESISTANCE

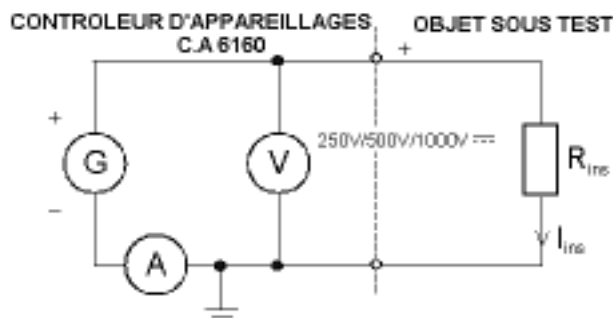

Fig. 20. Test circuitry

How to carry out the measurement

STEP 1. Set rotary switch to **ISO** (insulation resistance) position, the following heading is displayed

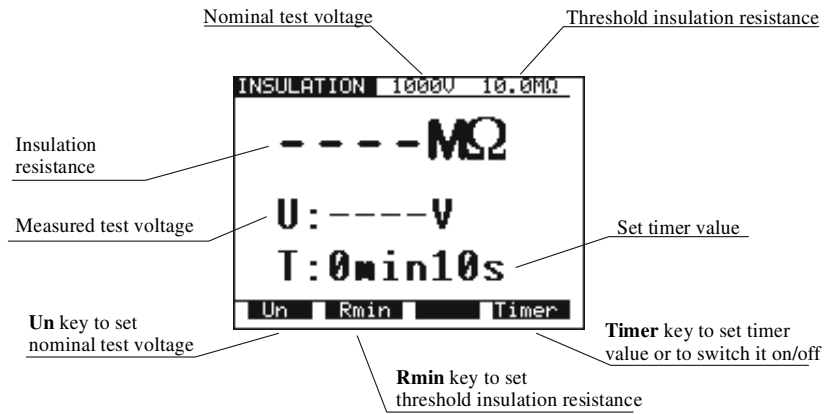

Fig. 21. Basic heading in ISO function

STEP 2. Select test parameters as follows:

■ Insulation resistance threshold

Press **Rmin** key in order to reach menu for selection of insulation resistance threshold, see the following figure.

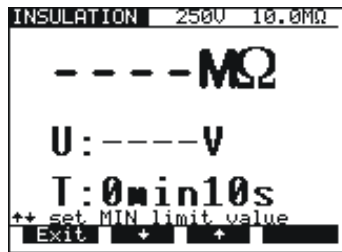

Fig. 22. Insulation resistance threshold selection menu

- Use \uparrow and \downarrow keys to select appropriate threshold value. If the displayed result is lower than the set threshold limit value, it will be accompanied by an error sound signal (after completion of the measurement). There will be no threshold value selected and no sound signal will be activated if «*** MΩ» sign is selected instead of threshold limit.
- Press **Exit** key to exit Insulation resistance threshold selection menu.
- Test voltage
 - Use **Un** key to select appropriate test voltage (250V \equiv , 500V \equiv or 1000V \equiv).
- Timer value
 - See instructions on how to set the value in paragraph 4.1. STEP 2.
- Timer ON/OFF
 - See instruction in paragraph 4.1. STEP 2.

STEP 3. Connect test probes to the instrument and to equipment to be tested as shown in figure below:

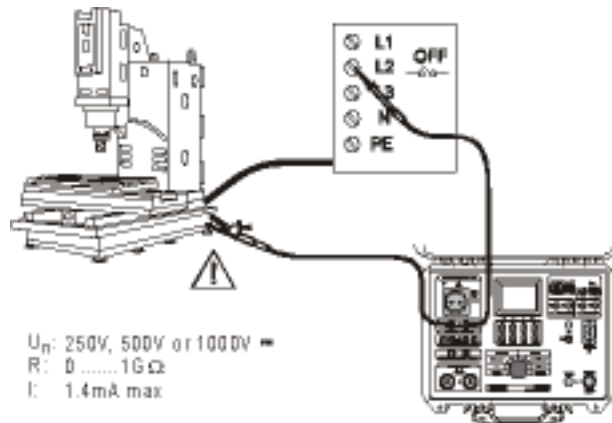

Fig. 23. Connection of test leads

STEP 4. Press **START/STOP** key to start the measurement.

STEP 5. Wait for test time to elapse (if the timer has been switched on) or press **START/STOP** key again to stop the measurement.

STEP 6. Save displayed result for documentation purpose (see instruction in chapter 5.2. on how to save displayed result).

NOTE !

Do not disconnect measured object before it is discharged.

4.6. DISCHARGE TIME - EXTERNAL (INPUT MAINS TEST)

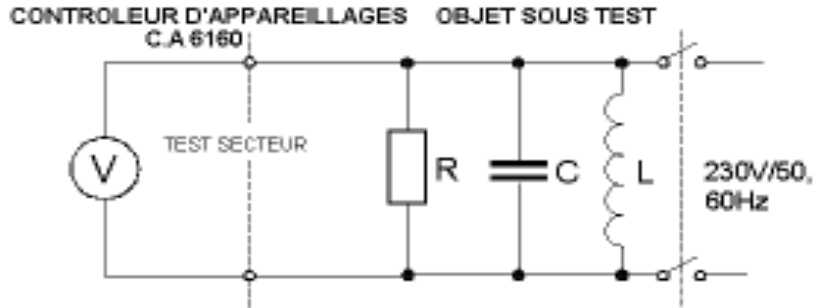

Fig. 24. Test circuitry

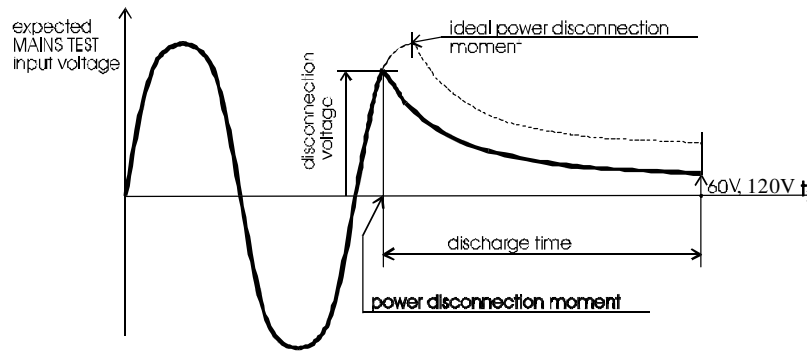

Fig. 25. Voltage on MAINSTEST input

External discharge time is calculated as the input voltage is maximum allowed voltage of the currently connected mains supply system. The instrument is constructed to measure external discharge time in three different mains supply systems (115 V, 230 V and 400 V). The voltage is calculated according to the following nominal voltage peak values:

- 179 Vp = (115 V + 10 %)x√2 (60 V < Up < 235 V)
- 344 Vp = (230 V + 6 %)x√2 (235 V < Up < 425 V)
- 596 Vp = (400 V + 6 %)x√2 (425 V < Up < 600 V)

How to carry out the measurement

STEP 1. Set rotary switch to **DISC.TIME** (discharge time) position. The following heading is displayed.

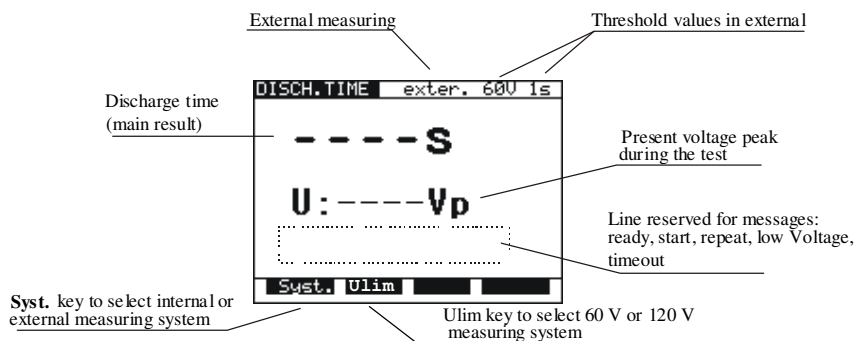

Fig. 26. Main menu in Discharge time function

STEP 2. Select external system measurement by pressing **SYST.** key (**exter. 60 V 1 s** or **exter. 120 V 1 s** is displayed).

STEP 3. Select 60 V or 120 V measuring system using **Ulim** key.

STEP 4. Connect test cable to the instrument and to the equipment to be tested as shown in figure below.

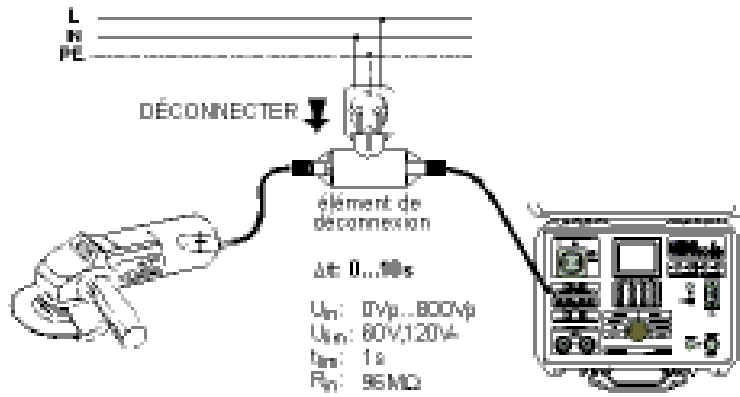

Fig. 27. Connection of test cable

STEP 5. Press **START/STOP** key to prepare the instrument for switching off mains voltage. **Ready** is displayed after approx 1 s. **Low Voltage** message is displayed if the voltage on input mains is not appropriate (less than min working voltage) or the input is not connected to the mains (check input circuit, mains voltage, double connection element is not properly plugged in, etc.).

STEP 6. Pull out double connection element and wait for the result to be displayed. If the disconnection voltage is high enough to carry out a measurement, (see fig. 25) **Start** message is displayed and the measurement will be performed. If the voltage is not high enough then the result of 0.0 s and **Repeat** message are displayed. In this instance repeat measurement from STEP 3. If the result 0.0 s and **Repeat** message reappears repeat measurement 5 to 10 times successively, the result 0.0. it can be accepted as valid. **Timeout** is displayed if the double connection element is not pulled out in 10 s, or discharging time is higher than 10 s.

STEP 7. Save displayed result for documentation purposes (see instructions in chapter 5.2. on how to save displayed result).

4.7. DISCHARGE TIME-INTERNAL

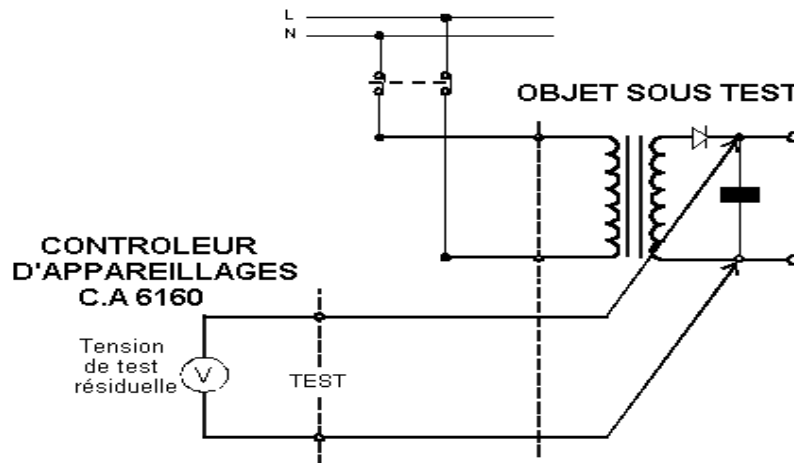

Fig. 28. Test circuitry

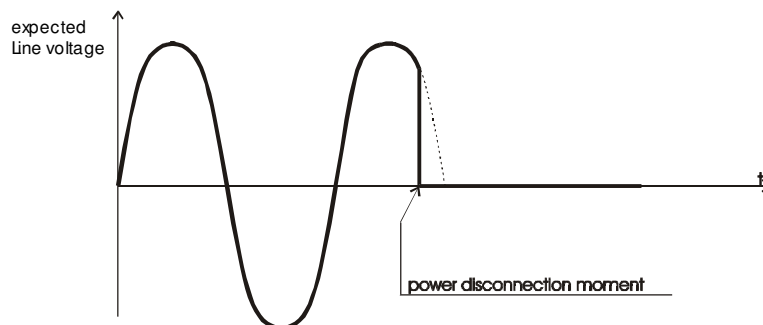

Fig. 29. Expected voltage on tested object input

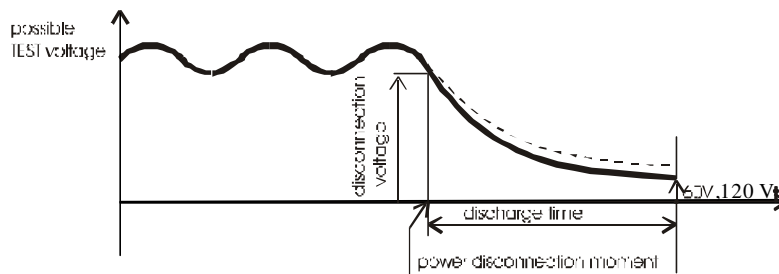

Fig. 30. Expected voltage on discharge input

How to carry out the measurement

- STEP 1.** Set rotary switch to **DISC.TIME** (discharge time) position. The heading according to fig.26 is displayed.
- STEP 2.** Select internal system measurement by pressing **SYST.** key (**inter. 60 V 5 s** or **inter. 120 V 5 s** is displayed).
- STEP 3.** Select 60 V or 120 V measuring system using **Ulim** key.
- STEP 4.** Connect test cables to equipment under test and the tested item to line voltage as shown in figure below.

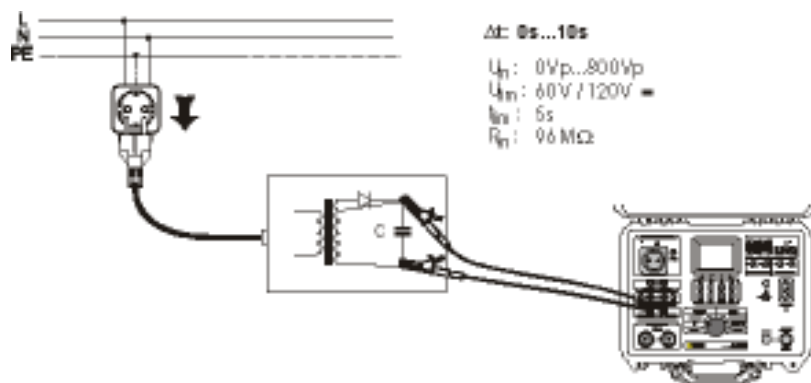

Fig. 31. Connection of test cables

- STEP 5.** Press **START/STOP** key to prepare the instrument for switching off mains voltage. **Ready** is displayed after 1 s approx. **Low Voltage** message is displayed if the voltage on input mains is not appropriate (less than min working voltage) or not connected (check input circuit, mains voltage).
- STEP 6.** Pull out power supply connector and wait for the result to be displayed. If the disconnection voltage is high enough to carry out a measurement, (see fig. 25) **Start** message is displayed and the measurement will be performed. If the voltage is not high enough then the result 0.0 s and **Repeat** message are displayed. In this instance repeat measurement from STEP 3. If the result 0.0 s and **Repeat** message reappears repeat measurement 5 to 10 times successively, the result 0.0. it can be accepted as valid. **Timeout** is displayed if the double connection element is not pulled out in 10 s, or discharging time is higher than 10 s.
- STEP 7.** Save displayed results for documentation purpose (see instruction in chapter 5.2. on how to save displayed results).

4.8. LEAKAGE CURRENTS

4.8.1. LEAKAGE CURRENT

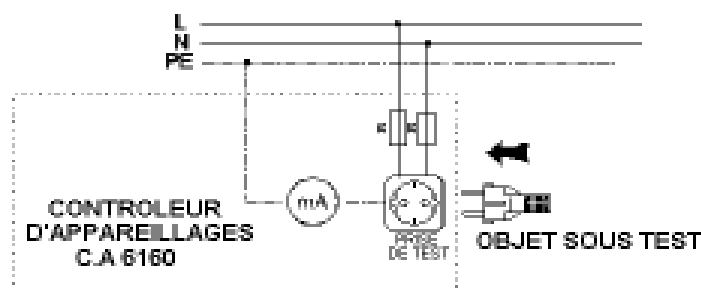

Fig. 32. Test circuitry

How to carry out the measurement

STEP 1. Set rotary switch to **LEAKAGE** position. The following heading is displayed.

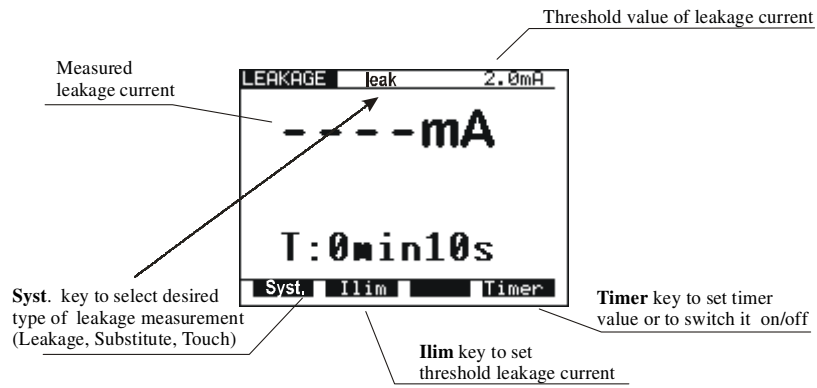

Fig. 33. Main menu in Leakage current function

STEP 2. Select test parameters as follows:

- Pres **Syst.** key to select **leak**
- Leakage current threshold
 - Press **Ilim** key to open menu to change leakage current threshold value.
 - Use \uparrow and \downarrow keys to select appropriate threshold value.
 - Press **Exit** key to exit menu.
- Timer value
 - See instructions on how to set the value in paragraph 4.1., STEP 2.
- Timer ON/OFF
 - See instructions in paragraph 4.1., STEP 2.

STEP 3. Connect tested item into test socket on the instrument as shown in figure below.

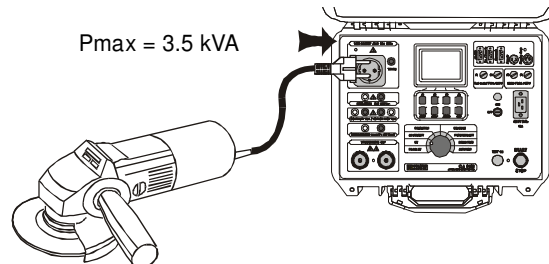

Fig. 34. Connection of tested object

STEP 4. Press **START/STOP** key to start the measurement.

STEP 5. Wait for the test time to elapse (if the timer has been switched on) or press **START/STOP** key again to stop the measurement.

STEP 6. Save displayed result for documentation purpose (see instructions in chapter 5.2. on how to save displayed result).

4.8.2. SUBSTITUTE LEAKAGE CURRENT

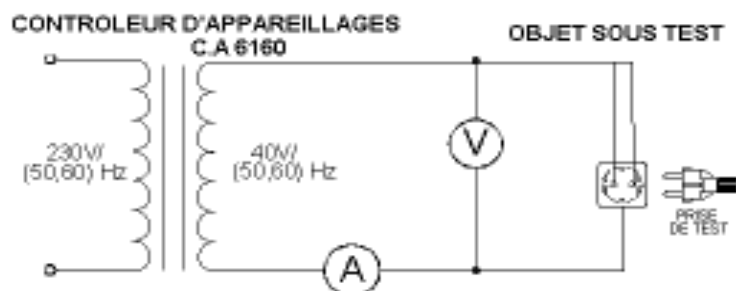

Fig. 35. Test circuitry

How to carry out the measurement

STEP 1. Set rotary switch to **LEAKAGE** position.

STEP 2. Select test parameters as follows:

Pres **Syst.** Key to select **subst**

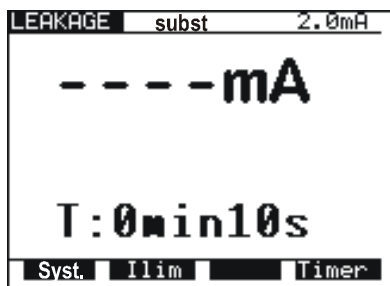

Fig. 36. Heading in Substitute Leakage current function

- Set Leakage current threshold
 - Press **Ilim** key to open menu to change leakage current threshold value.
 - Use **↑** and **↓** keys to select appropriate threshold value.
 - Press **Exit** key to exit menu.
- Timer value
 - See instructions on how to set the value in paragraph 4.1. STEP 2.
- Timer ON/OFF
 - See instructions in paragraph 4.1. STEP 2.

STEP 3. Connect tested item into test socket on the instrument as shown in figure below.

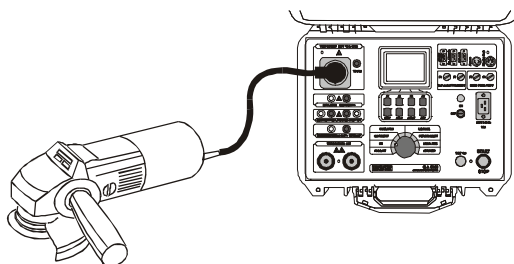

Fig. 37. Connection of tested object

STEP 4. Press **START/STOP** key to start the measurement.

STEP 5. Wait for the test time to elapse (if the timer has been switched on) or press **START/STOP** key again to stop the measurement.

STEP 6. Save displayed result for documentation purpose (see instruction in chapter 5.2. on how to save displayed result).

4.8.3. TOUCH LEAKAGE CURRENT

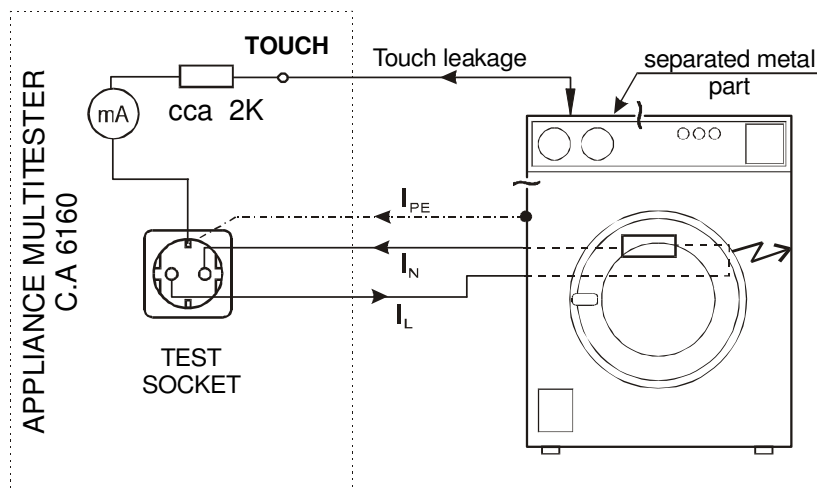

Fig. 38. Touch leakage test circuitry

How to carry out the measurement

STEP 1. Set rotary switch to **LEAKAGE** position.

STEP 2. Select test parameters as follows:

Pres **Syst.** Key to select **touch**

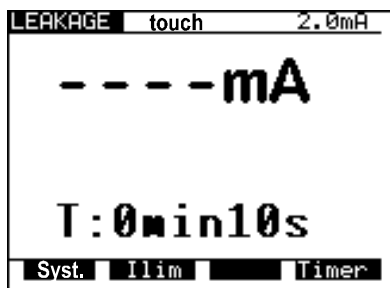

Fig. 39. Heading in Touch Leakage current function

- Set Leakage current threshold
 - Press **Ilim** key to open menu to change touch leakage current threshold value.
 - Use **↑** and **↓** keys to select appropriate threshold value.
 - Press **Exit** key to exit menu.
- Timer value
 - See instructions on how to set the value in paragraph 4.1., STEP 2.
- Timer ON/OFF
 - See instructions in paragraph 4.1., STEP 2.

STEP 3. Connect tested item into test socket on the instrument as shown in figure below.

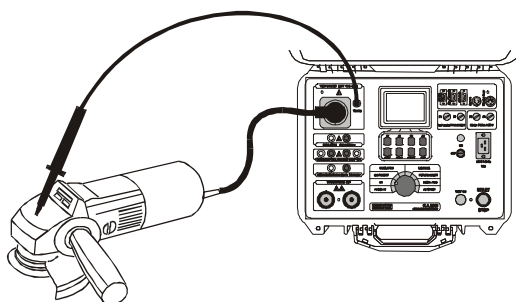

Fig. 40. Connection of tested object

STEP 4. Press **START/STOP** key to start the measurement.

STEP 5. Touch ungrounded metal part by using test probe.

STEP 6. Wait for the test time to elapse (if the timer has been switched on) or press **START/STOP** key again to stop the measurement.

STEP 7. Save displayed result for documentation purpose (see instruction in chapter 5.2. on how to save displayed result).

4.9. FUNCTIONAL TEST

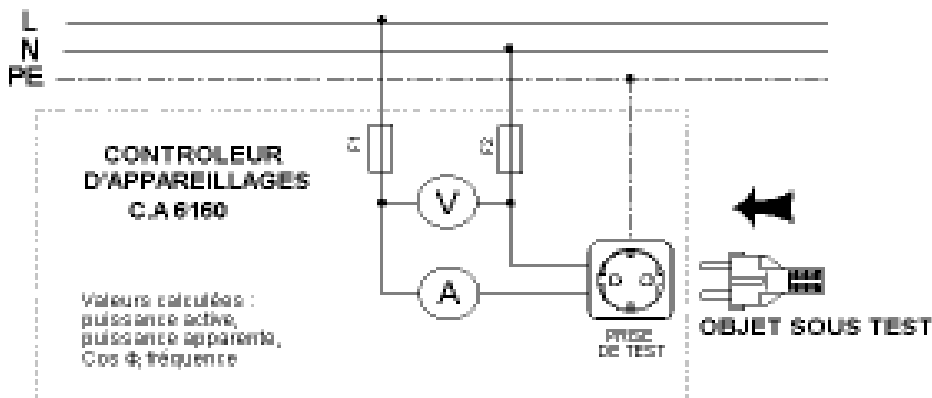

Fig. 41. Test circuitry

How to carry out the measurement

STEP 1. Set rotary switch to **FUNCTION. TEST** position, the following heading is displayed.

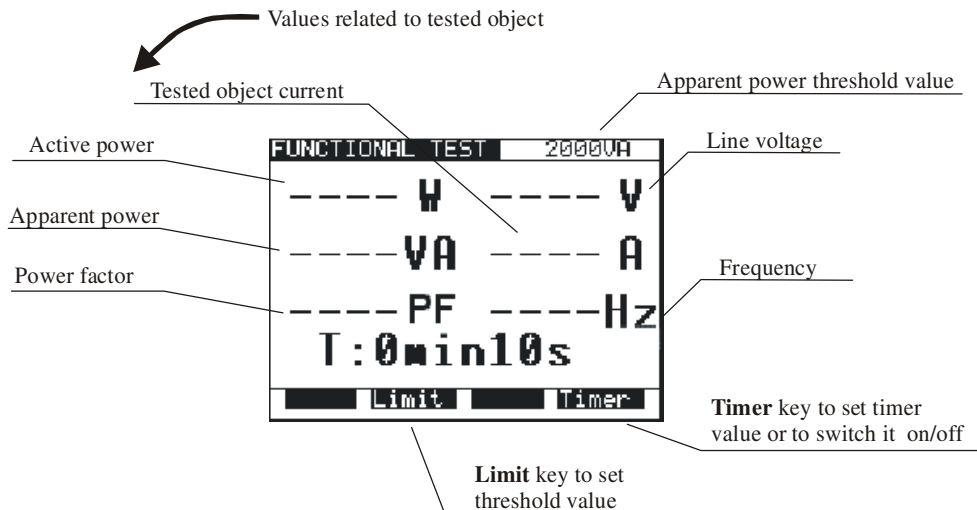

Fig. 42. Main menu in Functional test function

STEP 2. Select test parameters as follows:

- Apparent power threshold value
 - Press **Limit** key to open menu for changing power threshold value.
 - Use **↑** and **↓** keys to select appropriate threshold value.
 - Press **Exit** key to exit menu.
- Timer value
 - See instructions on how to set the value in paragraph 4.1., STEP 2.
- Timer ON/OFF
 - See instructions in paragraph 4.1. STEP 2.

STEP 3. Connect the tested equipment into test socket on the instrument as shown in **Leakage current** paragraph.

STEP 4. Press **START/STOP** key to start the measurement.

STEP 5. Wait for the test time to elapse (if the timer has been switched on) or press **START/STOP** key again to stop the measurement.

STEP 6. Save displayed result for documentation purposes (see instructions in chapter 5.2. on how to save displayed result).

NOTE !

A message "Load on TEST SOCKET" is displayed if the ROTARY SWITCH is in positions PROG. HV, HV, CONTINUITY, ISO, or AUTO, and load is present on TEST SOCKET.

4.10. AUTOTEST

Autotest is a very powerful tool, which is constructed to make the process of measurement easier, more flexible or even automatic. It gives an assurance that the complete measurement procedure is carried out. Any previously designed sequence by CE Link software (up to 10 sequences, each composed of up to 50 steps can be saved in APPLIANCE MULTITESTER memory) will be executed step by step. Every measurement result, which has not passed, will be signaled and the automatic procedure will be stopped. When the user removes the cause of the error, he can continue the procedure by pressing START button. In this way the user is sure that every step will be completed with PASS result. The user can decide to skip the failed measurement using SKIP command on the instrument. The result of skipped measurement is not saved into the memory. When REMOTE CONTROL PEDAL is used and the procedure is stopped at PAUSE or MESSAGE step of sequence, you can continue the procedure only by pressing START button on the instrument. Rotating the rotary switch during autotest sequence execution is not allowed, otherwise the instrument can block up.

Autotest is a very useful tool for the production line output check of manufactured products, or for laboratory verification that the tested electrical machine meets the appropriate standard. The results of output check can be downloaded (or auto-downloaded , after every tested product) to PC for documentation purpose. Auto-repeat and auto print function after each sequence can be selected in PC software. It is intended to automate the product line checking.

The only way to create autotest sequence is to use Sequence editor in CE Link PC software (32-bit application for Windows) see picture below.

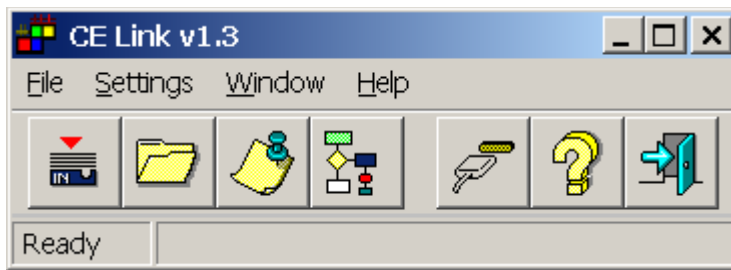

Fig. 43. Main CE Link window

For more information on options in sequence editor see chapter 7, **PC software - CE Link**. When the sequence is completed it must be sent to APPLIANCE MULTITESTER by using serial RS232 interface. After sending it, the PC does not need to be connected to the APPLIANCE MULTITESTER.

How to carry out the measurement

STEP 1. Install CE Link PC software on your PC.

STEP 2. Using Sequence editor, create the desired sequence. Max. number of steps for each sequence is 50 including programmed pause, messages, barcode reader sequence, sound signals etc.

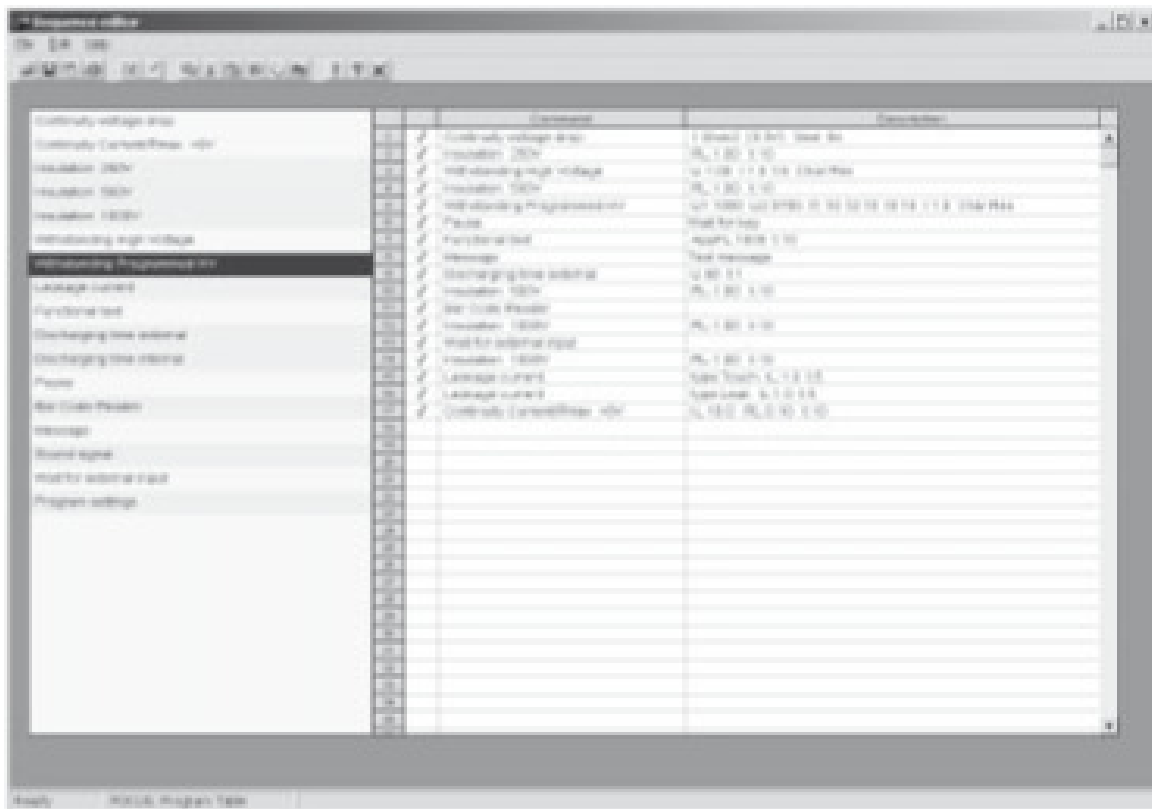

Fig. 44. Sequence editor window

STEP 3. Set rotary switch on the instrument to **AUTOTEST** position, the heading in fig.45 is displayed.

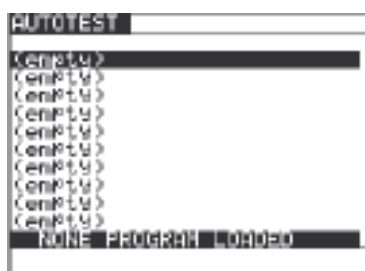

Fig. 45. Main menu in Autotest function (initially no program loaded)

STEP 4. Send programmed sequence to DIELECTRIC STRENGTH TESTER from “List of instrument’s programs” menu by using **Send** button. After the transfer is completed the name of the user designed procedure is displayed on the list of programs. Up to 10 sequences can be sent to the instrument.

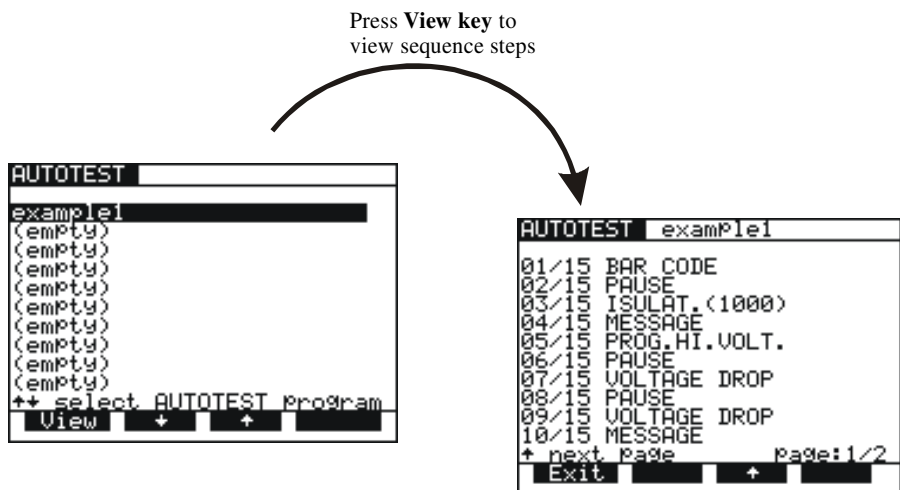

Fig. 46. Sequence name is displayed, to display individual steps press View key

STEP 5. Press **START/STOP** key to start the measurements that compose the sequence.

NOTE !

Do not rotate the rotary switch during executing autotest sequence, otherwise the instrument can block up!

SEQUENCE EXAMPLE

Sequence example illustrates usage of AUTOTEST function at testing Luminaries according to IEC 60598-1 standard.

- STEP 1.** BAR CODE READER (optional reading of bar code to memory),
- STEP 2.** PAUSE {(1 - 600) s or Wait for key} (to check device is ready for CONT test),
- STEP 3.** CONTINUITY 10 A {I: 10 A; Rlim: 0.5 E; time: 1 s},
- STEP 4.** MESSAGE {ISO: **L+N** to **PE**} (notice to prepare device for ISO test),
- STEP 5.** INSULATION 500 V {Rlim: 2 M; time: 10 s},
- STEP 6.** MESSAGE {HV: **L+N** to **grounded case**} (notice to prepare device for HV test),
- STEP 7.** WITHSTANDING {U: 1.5 kV; Ilim: 5 mA; time: 60 s},
- STEP 8.** MESSAGE {HV: **L+N** to **nongr. case**} (notice to prepare device for HV test),
- STEP 9.** WITHSTANDING {U: 3.7 kV; Ilim: 5 mA; time: 60 s},
- STEP 10.** WAIT FOR EXTERNAL INPUT sequence will be continued after external impulse,
- STEP 11.** DISCHARGE Internal {U: 60 V; t: 5 s},
- STEP 12.** MESSAGE {LEAK.: **L** to **PE**; FUNCT.} (notice to prepare device for DISCH test and after PAUSE for FUNCT. Test),
- STEP 13.** LEAKAGE CURR. {Ilim: 1 mA; time: 5 s},
- STEP 14.** PAUSE {2 s},
- STEP 15.** FUNCTIONAL TEST {Plim: depend on luminary; t: 10 s},
- STEP 16.** SOUND SIGNAL {t: 1 s} (notice after conclusion of testing),
- STEP 17.** MESSAGE {Testing successfully done}.
- STEP 18.** WAIT FOR EXTERNAL INPUT sequence will be continued after external user’s signal,
- STEP 19.** PROGRAM SETTINGS {Luminary test 1},

How to create sequence

Define all requested tests with their limits according to desired standard and tested device and arrange them into a sequence by logical order. Use PAUSE, MESSAGE, or WAIT FOR EXTERNAL INPUT functions between different tests to notify operator to prepare tested device for the appropriate following test.

Select **Auto repeat** option in Program settings to restart the sequence after it is done without pressing START button. Select **Save measurements** and **Auto send** options to send memorized results to PC after the sequence is done. CE Link enables to print Test Report after the results are received. All this functions together enable fully automated testing of products in production line. It is possible to manufacture test accessory (relay matrix) for suitable connection between tested device and APPLIANCE MULTITESTER. The equipment must be manufactured by customer according to their needs. It can be controlled by EXT output of APPLIANCE MULTITESTER through PIN 3 (Wait for external input) input signal and PIN 4 (Next test) output signal.

FLOW CHART of SEQUENCE EXAMPLE

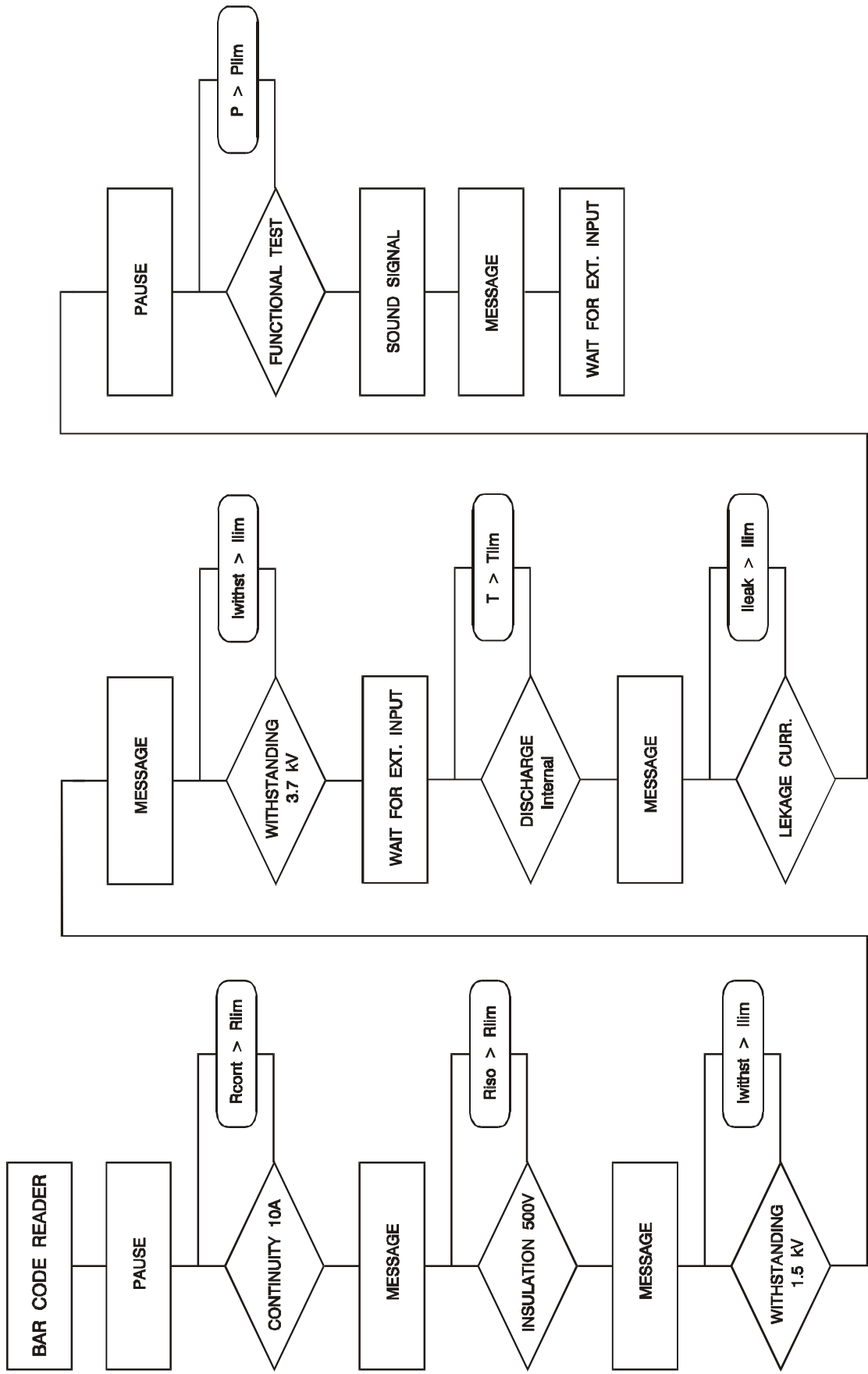

5. OPERATION

5.1. WARNINGS

Different warnings or information can be reported during manipulation with the APPLIANCE MULTITESTER. Here is a list of warnings and information for each function.

HV AND PROG.HV FUNCTION:

Trip out

The HV generator tripped-out due to the test current, which was higher than the set threshold value.

CONTINUITY FUNCTION:

Load on TEST SOCKET

or

Voltage on term. C1-C2

Voltage on term. P1-P2

External AC voltage connected to CONTINUITY input C1 – C2 (**voltage present on P1 and P2 too**), or TEST SOCKET loaded.

External AC voltage connected to CONTINUITY input P1 – P2 is higher than 12 V (**voltage present on C1 and C2 too**).

VOLTAGE DROP FUNCTION:

Load on TEST SOCKET

or

Voltage on term. C1-C2

Voltage on term. P1-P2

External AC voltage connected to CONTINUITY input C1 – C2, (**voltage present on P1 and P2 too**) or TEST SOCKET loaded.

External AC voltage connected to CONTINUITY input P1 – P2 is higher than 12 V (**voltage present on C1 and C2 too**).

ISO FUNCTION:

Voltage on term. ISO

External AC or DC voltage connected to ISO terminals is higher than 30 V.

DISCHARGING TIME FUNCTION:

Ready

Low Voltage

Start

displayed for approx. 1 s after pressing **START**.

displayed if the voltage on input mains is not appropriate or not connected.

displayed if disconnection voltage is high enough to carry out measurement, and the measurement will be performed.

Repeat

Time out

repeat measurement.

displayed if the connection element is not pulled out in 10 s or discharging time is higher than 10 s.

GENERAL:

HOT

The instrument is overheated (CONTINUITY, VOLT.DROP, HV and PROG.HV);  sign is also displayed.

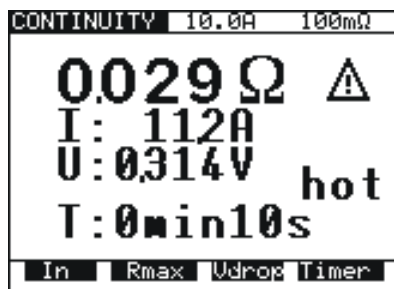

Fig. 47. Example of hot message

Measurements in functions ISO, LEAK.CURRENT, FUNCTION. TEST and DISC.TIME can still be carried out.

 No Earth 
No Voltage on TEST SOCKET
Load on TEST SOCKET

Earth connection is missing on mains power plug.

Check Fuses F3, F4 (16 A T).

Test socket is loaded in functions other than Leakage, Disch. time and Functionality.

Voltage on term. P1 - P2

Ext. AC voltage connected to P1-P2 input is higher than 12 V (**voltage present on C1 and C2 too**).

Voltage on term. ISO

External AC or DC voltage connected to ISO terminals is higher than 30V.

5.2. RESULTS MEMORIZING

Each displayed result can be stored to one of 1638 memory locations. In addition to the main result all subresults and test parameters are also saved and can be recalled and downloaded to PC. Each result is marked with memory index (Memory: _____), device number (Device: _____) and device barcode number (Barcode: _____).

The device number can be set from 001 up to 255 and there are memory indexes that belong to each device, which can be set from 001 up to 1638 until the whole storage is occupied.

Device: 001 Barcode: from device 001				
Memory: 0001	Memory: 0002	Memory: 0003		Memory: x

Device: 002 Barcode: from device 002				
Memory: 0001	Memory: 0002	Memory: 0003		Memory: y

Device: 255 Barcode: from device 255				
Memory: 0001	Memory: 0002	Memory: 0003		Memory: z

Fig. 48. Presentation of memory organization

How to save displayed results

The displayed result can be saved only after the measurement is complete.

STEP 0. Carry out the measurement.

STEP 1. Press **MEM** key in order to reach memory menu for saving results (see fig. below).

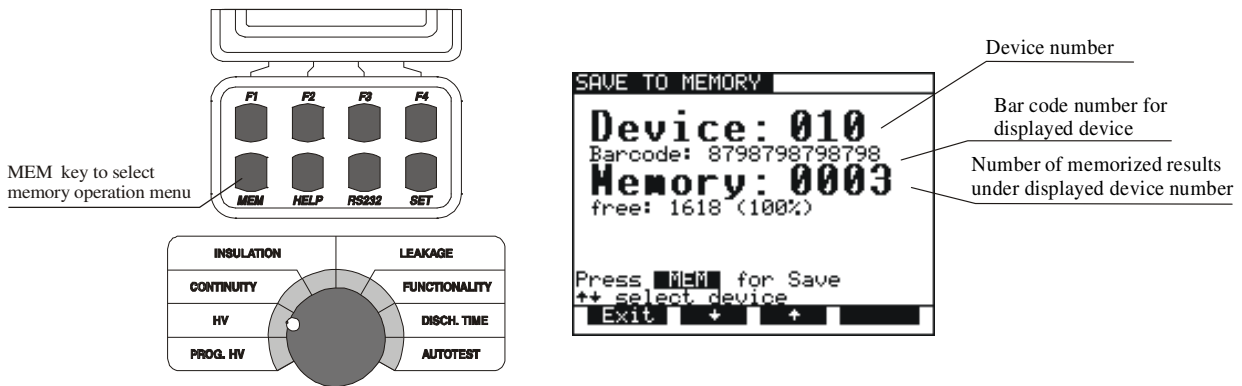

Fig. 49. Memory heading for saving results

STEP 2. Select device using \uparrow and \downarrow keys (default device is the last device used).

- Device number, Barcode from device and number of saved measurement on this device is displayed.
- See instruction in chapter 5.9. for how to get barcode number .

STEP 3. Press MEM key to save measured values / (Press Exit key to skip saving).

- After pressing MEM key memory menu will be automatically closed.

NOTES !

Memorizing procedure can be easily accomplished by pressing MEM key twice when the user does not want to change the device (in this case the user can skip the procedure for device setting because the instrument will automatically set the last device used).

- Each displayed result can be stored only once (in order to avoid double storing by mistake).
- Any further pressing of MEM key will enable only memory recall (recall from memory menu will be displayed).
- The result of BURN test cannot be saved.

5.3. RECALLING OF STORED RESULTS

The results can be recalled only before the measurement is performed or after the result is saved.

STEP 1. Press **MEM** key in order to reach memory menu for recalling results (see fig. below).

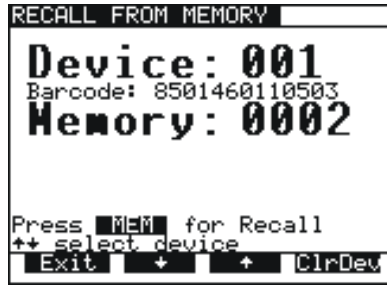

Fig. 50. Memory heading for recalling from memory

STEP 2. Select device using \uparrow and \downarrow keys.

- If for some reason the device has to be cleared press **ClrDev** key, ("press ClrDev to confirm" message will be displayed to prevent clearing by mistake). Press **ClrDev** key to confirm or **Exit** to cancel clearing procedure.

STEP 3. Press **MEM** key to recall saved results under chosen device.

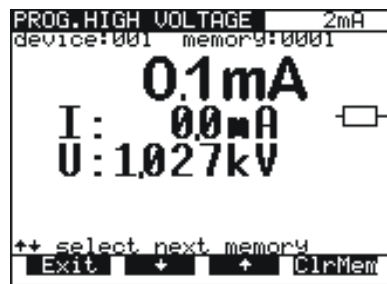

Fig. 51. Recalled result under device 001

STEP 4. Select result you are looking for by using \uparrow and \downarrow keys.

- To clear memory location press **ClrMem** key.

STEP 5. Press **Exit** key to exit menu.

5.4. RS 232 COMMUNICATION

In order to transfer stored data to PC, RS 232 communication feature must be used.

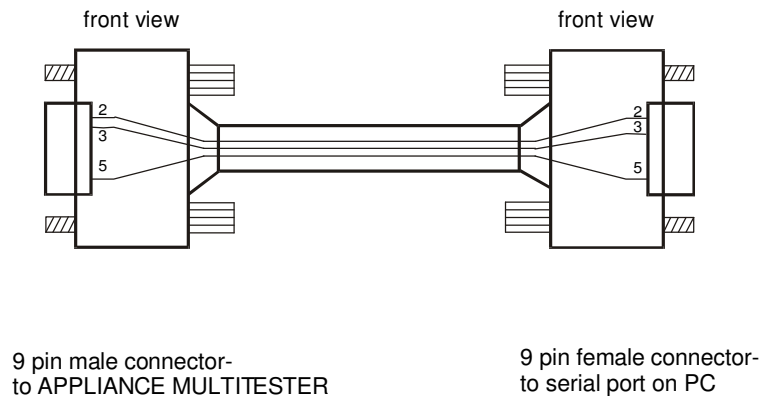

Fig. 52. RS 232 communication cable

NOTE !

Use original RS 232 communication cable or connect only pins on serial DB9 connectors according to Fig. 52 to avoid damages (pin 2, 3, 5).

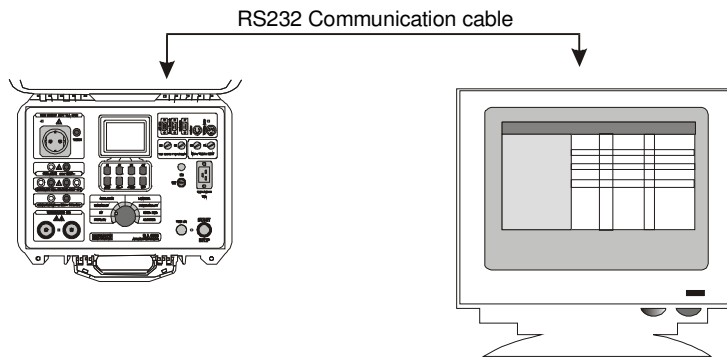

Fig. 53. Connection of APPLIANCE MULTITESTER to PC

How to transfer stored data to PC

- STEP 1. Connect APPLIANCE MULTITESTER to PC as shown in fig. 53 using appropriate RS 232 communication cable.
- STEP 2. Open CE Link program on your PC.
- STEP 3. Set baud rate (the same on PC and APPLIANCE MULTITESTER).
- STEP 4. Use ↑ and ↓ keys to select one of displayed options and press **Enter** key
- STEP 5. After pressing **Enter** key the selected function submenu is displayed at the bottom of menu:

5.5. SYSTEM CONFIGURATION

To reach System configuration menu the following procedure must be carried out:

- STEP 1. Switch off the instrument turning **ON/OFF** key to OFF position.
- STEP 2. Press **SET UP** key and keep it pressed **while switching on** the instrument.
- STEP 3. System configuration menu is displayed (see figure below).

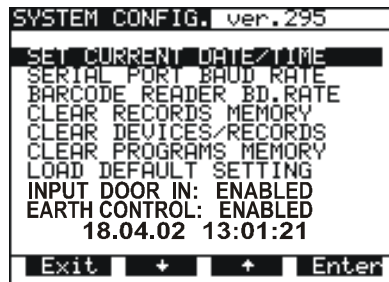
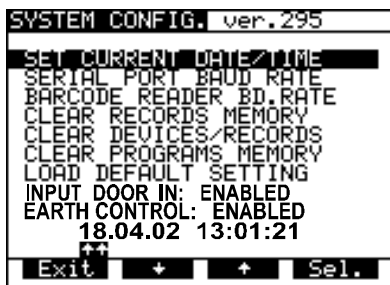

Fig. 54. Basic system configuration heading

- STEP 4. Use ↑ and ↓ keys to select one of displayed options and press **Enter** key
- STEP 5. After pressing **Enter** key on selected function message on the bottom of heading is displayed:



DATE and TIME setup:

- Use **Sel.** and ↑, ↓ keys to set **day, month, year, hour, minutes** and **seconds**. Year must be set manually at the beginning of each year when the time passes from 31.12 to 1.1. The warning "SYSTEM ERROR" is displayed otherwise. After Exit is selected the change will be confirmed and the main system menu is offered to allow selection of other functions or to exit to normal measuring mode.



SERIAL PORT BAUD RATE setup:

- Use **Sel.** key to select appropriate baud rate from 9600, 19200 or 38400. After exit, the new baud rate will be confirmed and basic menu is displayed.

```

SYSTEM CONFIG. ver.295
SET CURRENT DATE/TIME
SERIAL PORT BAUD RATE
BARCODE READER BD.RATE
CLEAR RECORDS MEMORY
CLEAR DEVICES/RECORDS
CLEAR PROGRAMS MEMORY
LOAD DEFAULT SETTING
INPUT DOOR IN: ENABLED
EARTH CONTROL: ENABLED
          9.6  4.8  2.4
Exit  Sel.

```

BARCODE READER BAUD RATE setup:

- Use **Sel.** keys to select appropriate baud rate from: 2400, 4800 or 9600.
- After exit, the new baud rate will be confirmed and basic menu is displayed.

```

SYSTEM CONFIG. ver.295
SET CURRENT DATE/TIME
SERIAL PORT BAUD RATE
BARCODE READER BD.RATE
CLEAR RECORDS MEMORY
CLEAR DEVICES/RECORDS
CLEAR PROGRAMS MEMORY
LOAD DEFAULT SETTING
INPUT DOOR IN: ENABLED
EARTH CONTROL: ENABLED
press ENTER for confirm
Exit  Enter

```

CLEAR all RECORDS:

- Press **Enter** to confirm or **Exit** to cancel.

NOTE !

Device and bar code numbers will not be erased. To clear individual records use **Recall from memory** menu or CE link software.

```

SYSTEM CONFIG. ver.295
SET CURRENT DATE/TIME
SERIAL PORT BAUD RATE
BARCODE READER BD.RATE
CLEAR RECORDS MEMORY
CLEAR DEVICES/RECORDS
CLEAR PROGRAMS MEMORY
LOAD DEFAULT SETTING
INPUT DOOR IN: ENABLED
EARTH CONTROL: ENABLED
press ENTER for confirm
Exit  Enter

```

CLEAR all DEVICES:

- Press **Enter** to confirm or **Exit** to cancel clearing of memory.

NOTE !

Before clearing, **download** all memorized results to PC to avoid losing important data.

```

SYSTEM CONFIG. ver.295
SET CURRENT DATE/TIME
SERIAL PORT BAUD RATE
BARCODE READER BD.RATE
CLEAR RECORDS MEMORY
CLEAR DEVICES/RECORDS
CLEAR PROGRAMS MEMORY
LOAD DEFAULT SETTING
INPUT DOOR IN: ENABLED
EARTH CONTROL: ENABLED
press ENTER for confirm
Exit  Enter

```

CLEAR all PROGRAMS:

- Press **Enter** to confirm or **Exit** to cancel clearing of memory.

NOTE !

Before clearing, **download** all memorized results to PC to avoid losing important data.

```

SYSTEM CONFIG. ver.295
SET CURRENT DATE/TIME
SERIAL PORT BAUD RATE
BARCODE READER BD.RATE
CLEAR RECORDS MEMORY
CLEAR DEVICES/RECORDS
CLEAR PROGRAMS MEMORY
LOAD DEFAULT SETTING
INPUT DOOR IN: ENABLED
EARTH CONTROL: ENABLED
press ENTER for confirm
Exit  Enter

```

LOAD DEFAULT SETTING :

Sets all adjustable test parameters to their initial values.

- Press **Enter** key to confirm or **Exit** key to exit.

```

SYSTEM CONFIG. ver.295
SET CURRENT DATE/TIME
SERIAL PORT BAUD RATE
BARCODE READER BD.RATE
CLEAR RECORDS MEMORY
CLEAR DEVICES/RECORDS
CLEAR PROGRAMS MEMORY
LOAD DEFAULT SETTING
INPUT DOOR IN: DISABLED
EARTH CONTROL: ENABLED
18.04.02 13:01:21
Exit  +  +  Enter

```

INPUT DOOR IN:

Enables or to disables DOOR IN input.

- After selecting this option press **Enter** to switch between ENABLE and DISABLE

```

SYSTEM CONFIG. ver.295
SET CURRENT DATE/TIME
SERIAL PORT BAUD RATE
BARCODE READER BD.RATE
CLEAR RECORDS MEMORY
CLEAR DEVICES/RECORDS
CLEAR PROGRAMS MEMORY
LOAD DEFAULT SETTING
INPUT DOOR IN: ENABLED
EARTH CONTROL: DISABLED
18.04.02 13:01:21
Exit  +  +  Enter

```

EARTH CONTROL:

If one wishes to enable or to disable EARTH CONTROL .

- After selecting this option press enter to switch between ENABLE and DISABLE

NOTE !

It is advisable to disable this option only in protected IT systems. For TN systems you should always enable it.

List of test parameters for each function, and their initial values:

Function	Parameter	Range of adjustment or possible values	Initial value
PROG.HV	U_N test voltage	100 V - 5 kV ~	$U_1 = 1$ kV $U_2 = 3,7$ kV
	I_{max} tripping current	(0.5, 1.0, 1.5 2.0, 2.5, 3.0, 3.5, 4.0, 4.5, 5.0, 5.5, 6.0, 6.5, 7.0, 7.5, 8.0, 8.5, 9.0, 9.5, 10, 20, 30, 40, 50, 60, 70, 80, 90, 100, 150, 200, 250, 300, 350, 400, 450, 500) mA	2 mA
	T timer	1 s - 240 s with resolution 1 s	$T_1 = 10$ s $T_2 = 10$ s $T_3 = 10$ s
HV	U_N test voltage (for I limit and burn mode)	100 V - 5 kV ~	1 kV
	I_{max} tripping current	(0.5, 1.0, 1.5 2.0, 2.5, 3.0, 3.5, 4.0, 4.5, 5.0, 5.5, 6.0, 6.5, 7.0, 7.5, 8.0, 8.5, 9.0, 9.5, 10, 20, 30, 40, 50, 60, 70, 80, 90, 100, 150, 200, 250, 300, 350, 400, 450, 500) mA	2 mA
	T timer	1 s - 9 min 59 s with resolution 1 s	10 s

Function	Parameter	Range of adjustment or possible values	Initial value
Continuity	I_N test current	100 mA, 200 mA, 10 A, 25 A~	10 A
	R_{max} max. allowed resistance	(10 - 990) m Ω (by steps of 10 m Ω) (1000 - 2000) m Ω (by steps of 100 m Ω) or *** Ω (no limit)	100 m Ω
	t timer	(1 - 59) s	10 s
Voltage Drop	ΔU_{max} .max. allowed voltage drop	5.0 V (0.50 mm ²), 5.0V (0.75 mm ²), 3.3 V (1.0 mm ²), 2.6V (1.5 mm ²), 1.9 V (2.5 mm ²), 1.4V (4.0 mm ²), 1.0 V \geq 6.0 mm ²	3.3 V (1 mm ²)
	t timer	(1 - 59) s	10 s
ISO	U_N test voltage	250 V, 500 V, 1000V =	500 V =
	R_{min} . min. allowed insulation resistance	(0.2 - 9.9) M Ω (by steps of 0.1 M Ω) (10 - 200) M Ω (by steps of 1 M Ω) or *** M Ω (no limit)	1 M Ω
	t timer	1 s - 9 min 59 s with resolution 1 s	10 s
LEAKAGE	I_{max} threshold current	Leakage, Substitut (0.00 - 20.0) mA Touch (0.00 - 2.00) mA	1m A
	t timer	1 s - 9 min 59 s with resolution 1 s	10 s
Function. test	S_{max} threshold power	(10 - 3500) VA	1000 VA
	t timer	1 s - 9 min 59 s with resolution 1s	10 s
DISC. TIME	Syst measuring system	external (1 s), internal (5 s)	external (1 s)
	t timer ON/OFF	ON or OFF	ON
All functions	RS232 baud rate	9600, 19200, 38400	38400
	Barcode r. baud rate	2400, 4800, 9600	9600
	Contrast	(0 - 100) % (by steps of 2 %)	50 %

5.6. CONTRAST OF THE DISPLAY

Where there is insufficient readability of the display (display too dark or intensity of messages too weak), the appropriate contrast of the display should be set.

How to set appropriate contrast

It is possible to adjust contrast in all positions of main switch.

STEP 1. Press **SET** key together with **F3** to make the display darker or together with **F2** to make the display brighter (keep the keys pressed until the desired contrast is achieved)

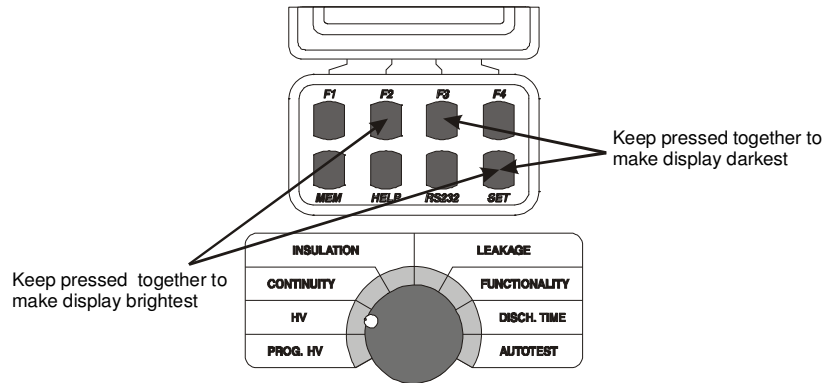

Fig. 55. How to set appropriate contrast

NOTE !

The selected contrast may change due to a change in temperature of the display (instrument heat or changed ambient temperature).

5.7. USE OF REMOTE CONTROL PEDAL

The pedal is intended to start and stop the measurement (in each function) as well as to save displayed results by foot. It is advisable to use the pedal when both hands are occupied with test probes, or when tests are to be carried out away from the instrument using longer test cables.

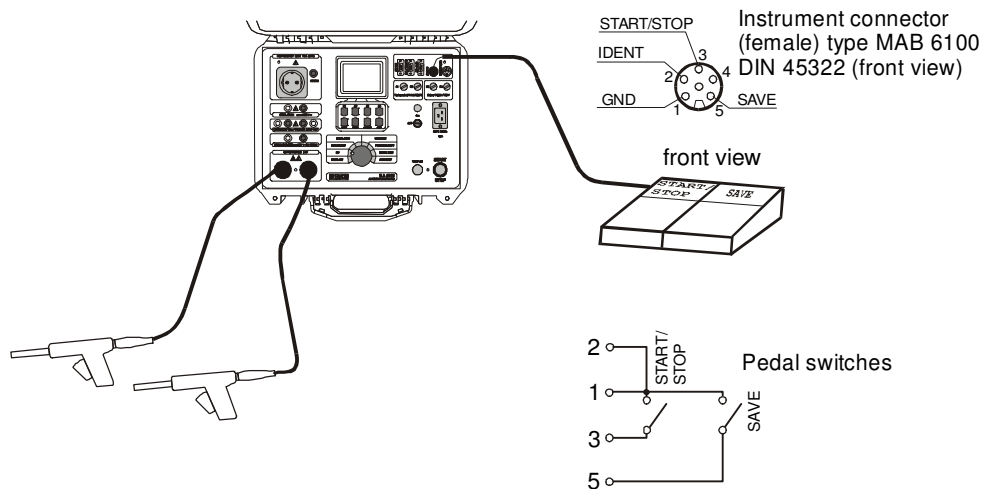

Fig. 56. Connection of remote control pedal to APPLIANCE MULTITESTER

NOTE !

The selected contrast may change due to a change in temperature of the display (instrument heat or changed ambient temperature).

How to operate REMOTE CONTROL pedal

START/STOP function on the pedal is exactly the same as on front panel of the instrument when the pedal is not connected.

SAVE function on the pedal is automatic, so a double press to SAVE pedal is required to save displayed result to the next location of set device number. The device number must be set in advance. If you press **SAVE** more than twice, the instrument will throw into **Recall** function and you cannot exit it by using REMOTE PEDAL. You can exit this function only by pressing front panel key on the instrument.

The following procedure is to be used:

- STEP 1.** Connect REMOTE CONTROL pedal to the instrument as it is shown in fig.56 and carry out the measurement by pressing START/STOP pedal.
- STEP 2.** Save the first result to desired memory location (memory number and device number) using front panel keys, see the instructions in chapter 5.2.
- STEP 3.** Carry out the next test using START/STOP pedal.
- STEP 4.** Save the result by pressing SAVE pedal twice.
- STEP 5.** Proceed with the measurements.

Technical specifications of the pedal:

- Cable length 10 m
- Commands START/STOP, SAVE
- Casing metal
- Weight 2 kg
- Size (W×H×D) (300 × 55 × 175) mm

5.8. USE OF WARNING LAMP

The lamp is intended to inform the user if dangerous voltages are present when WITHSTANDING tests are carried out (HV and PROG.HV position).

Meaning of each lamp:

- Red (TEST) lamp **on** means that dangerous voltage is present at WITHSTANDING test terminals. **Take care when using test pistols!**
- Green (READY) lamp **on** means that the instrument is ready for the next measurement, dangerous voltage is not present at WITHSTANDING test terminals.

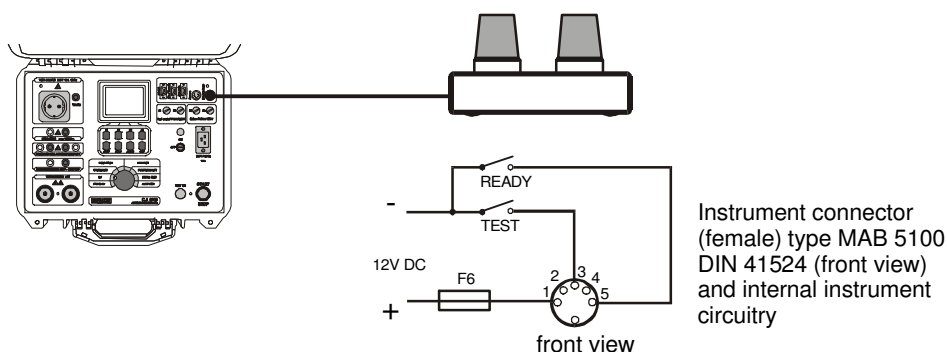

Fig. 57. Connection of warning lamp to APPLIANCE MULTITESTER

Technical specifications of the WARNING LAMP:

- Cable length 1 m
- Lamp bulbs (12 - 15) V / 4 W
- Casing plastic
- Weight 0.3 kg
- Size (W×H×D) (200 × 95 × 110) mm

NOTE !

If no lamp lights when rotary switch is in HV position, stop the measurements immediately and check the WARNING LAMP connection and light bulbs.

5.9. USE OF BARCODE READER

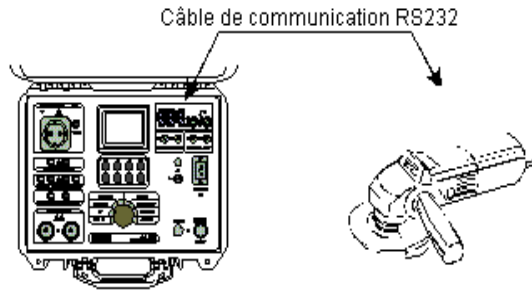

Fig. 58. Connection of barcode reader to APPLIANCE MULTITESTER

Use a barcode reader that includes RS232 communication with DB9 (male) connector. Select baud rate for barcode reader (see chapter 5.5 System configuration)

To add a barcode number to the currently enabled device use serial barcode reader. This operation is allowed in all measuring positions before or after the measurement.

After this action in memory menu, the bar code number is displayed together with device number and number of saved results.

5.10. USE OF EXT/DOOR INPUT

Specification of EXT. / DOOR IN signals:

Pin 2: Pass / Fail	(digital output)
Pin 3: External input	(digital input)
Pin 4: Next test	(digital output)
Pin 5: Door in	(digital input)
Pin 6: Gnd	

5.10.1. DOOR INPUT

If the DOOR IN input is enabled (see chapter 5.5 – System configuration), tests in PROG. HV and HV position will not be started until the door is not open. See figure below to connect DOOR IN signal to APPLIANCE MULTITESTER.

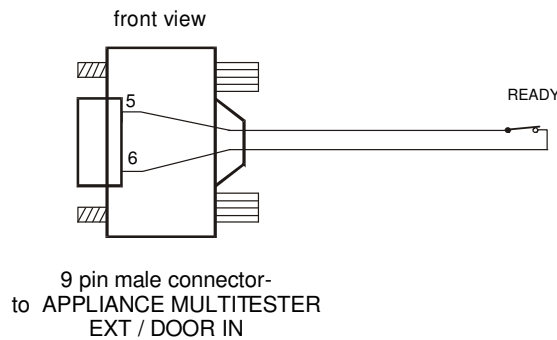

Fig. 59. Connection of DOOR IN signal to APPLIANCE MULTITESTER

5.10.2 EXTERNAL INPUT

EXT port is intended to

- show the result (PASS / FAIL) of measurement,
- give information during sequenced measurements (for AUTOTEST sequence),
- allow external control of AUTOTEST sequence execution.

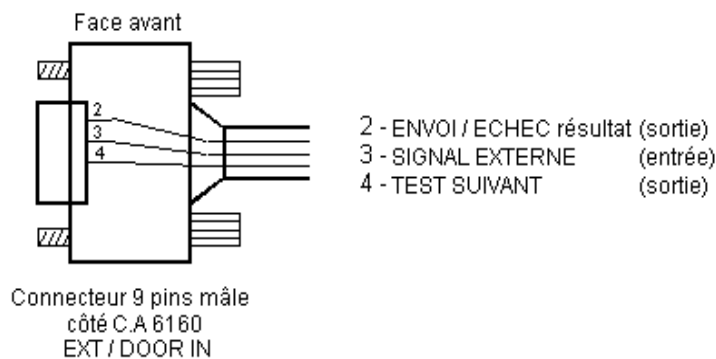

Fig. 60. Signals of EXT port

PASS / FAIL:

In autotest and individual measurements the status of measurement (PASS / FAIL) is given on pin 2 of EXT / DOOR IN connector. If the measurement result is inside the range of limit then pin 2 is **HI level**. If the measurement is out of limit range then pin 2 is **LO level**.

pin 2 – HI level: - the next program step of the autotest will be executed

pin 2 – LO level: - press **START** key to restart measurement
- press **Skip** key - program will continue with the next step
- press **Exit** key to stop program execution and return to AUTOTEST menu

External:

Pin 3 of DOOR IN input is supported by Autotest program command 'Wait for external input'. Generally the user can define four different kind of pause between two sequent measurements.

1. *Predefined time pause* - common equal pause between measurements (it can be set from 1 s to 5 s in sequence editor: Program name / Pause).
2. *Time pause* – it has to be inserted as a 'Pause' command as the last command in the *.SQC program. In this case the total pause between two sequent measurements is predefined time pause + Time of 'Pause' command.
3. *Message* - it has to be inserted as a 'Message' command in the *.SQC program. The instrument waits for the user reaction (connect test leads to tested object and press START).
4. *Wait for external input* – this command waits for change from HI to LO on pin 3 of DOOR / IN input (see figure below.)

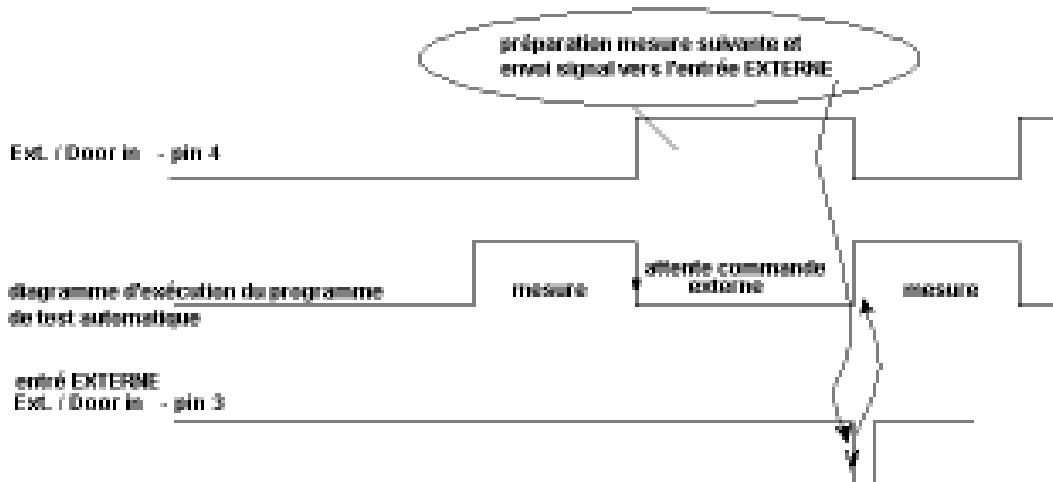

Fig. 61. Wait for external input diagram

Application example – unpredictable pause time for the same action (manual action is part of preparation for another measurement).

Next test:

Pin 4 indicates the end of execution of each measurement (change from LO to HI). Immediately after the start of another measurement it changes from HI to LO state.

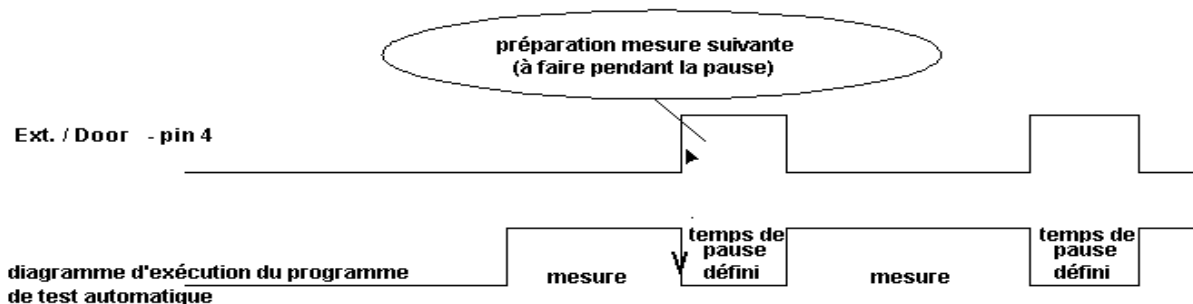

Fig. 62. Next test signal diagram

6. MAINTENANCE

6.1. METROLOGICAL CHECK

It is essential that all measurement instruments are regularly calibrated. We recommend an annual calibration to be carried out.

6.2. SERVICE

Repairs under or out of guarantee: Please return the products to your distributor.

6.3. CLEANING

To clean the surface of the instrument, use a soft cloth slightly moistened with soapy water or alcohol. Then leave the instrument to dry totally before use.

- **Do not use liquids based on petrol or hydrocarbons!**
- **Do not spill cleaning liquid over the instrument! Always moisten the cloth and then clean the instrument!**

6.4. REPLACING THE FUSES (BY PROPERLY TRAINED SERVICE PERSONNEL ONLY!)

In the case of instrument malfunction, send the instrument to an appropriate service center for all four fuses to be checked. See the purpose of each fuse in paragraph 3.9. Use original fuses only as declared in paragraph 3.9!



Disconnect all test cables and mains cord before opening the instrument.



Hazardous voltage may be present inside the instrument.

Properly trained service personnel only should carry out operation.
Position of fuses inside instrument:

F5	T 32A (10.3x38) mm 400V~ (inside instrument on front panel, protect continuity circuitry)
F6	F 500mA / 250V (on main PCB board, protect warning lamps outputs)

6.5. REPLACING THE BATTERY (BY PROPERLY TRAINED SERVICE PERSONNEL ONLY!)



This product contains a lithium battery the user must not remove.

6.6. REPAIRS

Repairs under or out of guarantee.
Please return the product to your distributor.

7. PC SOFTWARE - CE LINK

7.1. INSTALLING CE LINK

- CE Link software is 32-bit application for Windows platforms.
- Before installing CE Link it is recommended to close all running programs on your PC. After installation is complete there is no need to restart computer
- Insert installation disc in your computer and run SETUP.EXE.
- Standard Install Shield Wizard will guide you through installing process.
- Program will be installed in directory "C:\Program Files\CE Link" or in directory you select.
- After installation is done you are able to run CE Link.exe from Start menu.

WARNING:

This program is protected by copyright law and international treaties.

Unauthorized reproduction or distribution of this program, or any portion of it, may result in severe civil and criminal penalties, and will be prosecuted to the maximum possible under law.

7.2. INTRODUCTION NOTES

APPLIANCE MULTITESTER has a powerful Windows platform support tool – "CE Link". It is used for downloading of recorded data, additional analyzing of recorded data, for creating measurement sequences, for creating report documentation, and more.

Basic screen is start point for all actions.

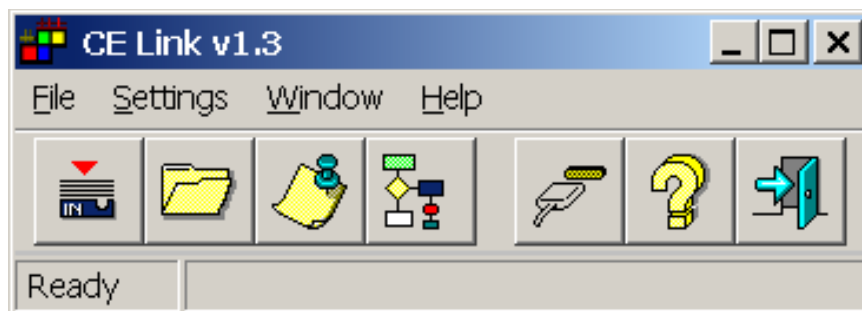

Fig. 63. Basic screen



	<p>Download data: Opens window for downloading or auto - downloading data from Appliance MultiTester to PC.</p> <p>Shortcut key: Alt F + D</p>		<p>Port settings: Opens window for port and baud rate settings.</p> <p>Shortcut key: Alt S + P</p>
	<p>Open data file: Opens window for analyzing recorded data file.</p> <p>Shortcut key: Alt F + O</p>		<p>Help: Opens help window.</p> <p>Shortcut key: Alt H</p>
	<p>Header programming: With this tool user can define header for printed documents.</p> <p>Shortcut key: Alt F + H</p>		<p>Exit: Exits CE Link.</p> <p>Shortcut key: Alt F + E</p>
	<p>Sequence editor: Tool for programming AUTOTEST sequences.</p> <p>Shortcut key: Alt F + S</p>		

Table. 1. Fast access buttons

7.3. DOWNLOAD DATA

Before starting “Download data” window it is necessary to:

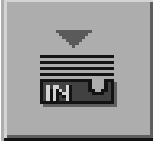
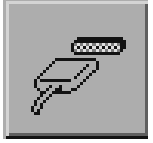
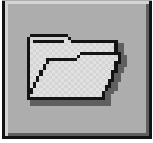
- Connect APPLIANCE MULTITESTER to PC according to figure 53 (chapter 5.4. RS 232 Communication) using appropriate RS 232 communication cable (Fig. 52).
- check et baud rate (same value must be set in CE Link and APPLIANCE MULTITESTER is necessary)

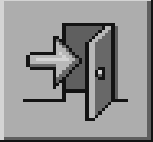
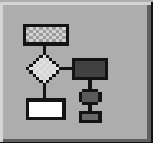
Set baud rate in CE Link software by using **Port settings** window.

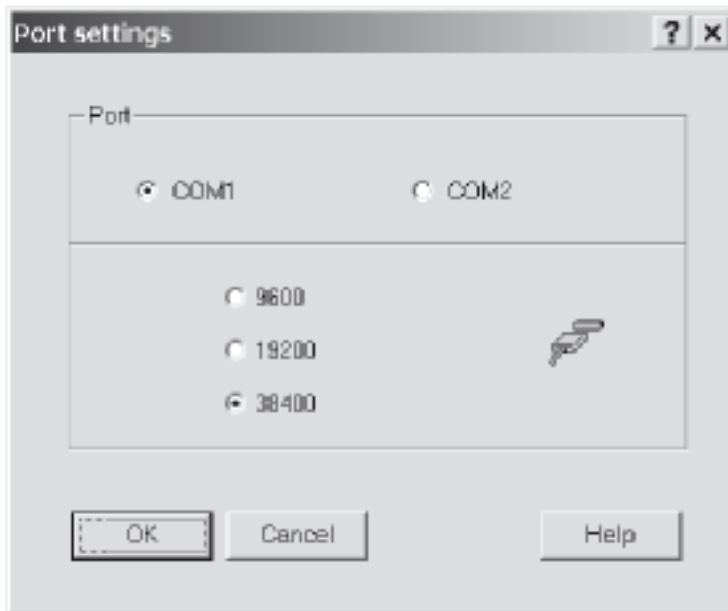

Fig. 64. Port settings window

- Check baud rate on APPLIANCE MULTITESTER by using **SET** key (see SERIAL PORT BAUD RATE setup in SYTEM CONFIGURATION in chapter 5.5)
- Prepare APPLIANCE MULTITESTER for communication by pressing **RS232** key (instrument will go in communication mode).
- Choose Download \ Standard download data option in main CE Link window



Fig. 65. Standard download mode

- After message "Downloading in progress..." is displayed and if the downloading is done successfully, the user will define name for this data file and it will be saved on disc in desired folder by pressing **Save** key.

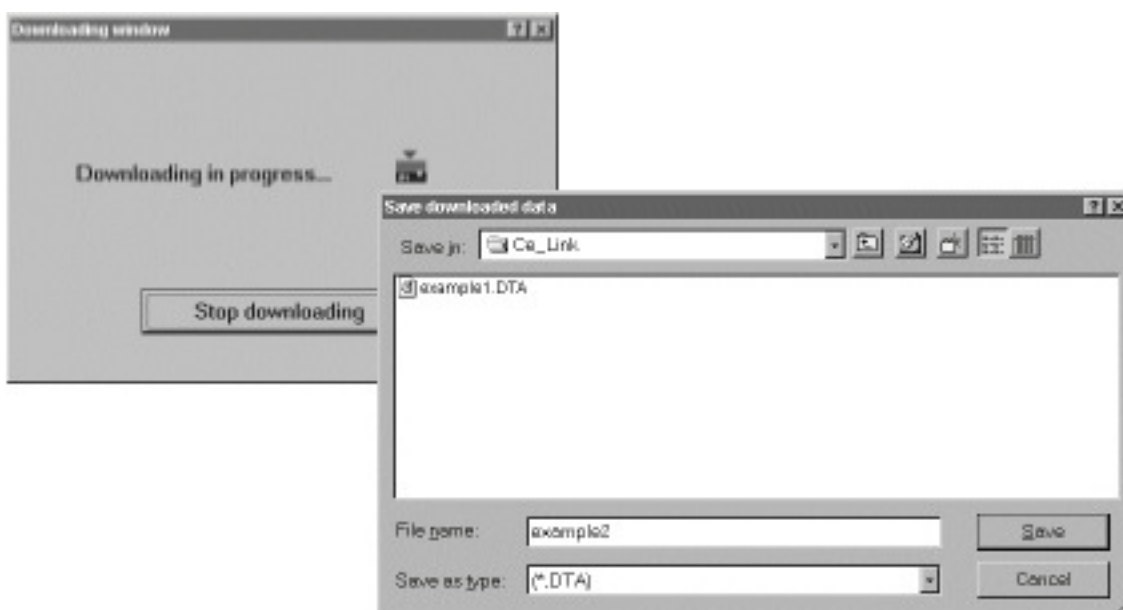

Fig. 66. Downloading data windows

- For auto download from instrument (instrument must be in the **Autotest mode**) choose **AutoReceive download** option. In this mode PC waits to receive record from the instrument. Instrument sends record to the PC at the end of each sequence procedure. After downloading the sequence will be executed again. For details of sequence creating see chapter 7.6 **Sequence editor** (in program definition window AutoSend option has to be enabled)

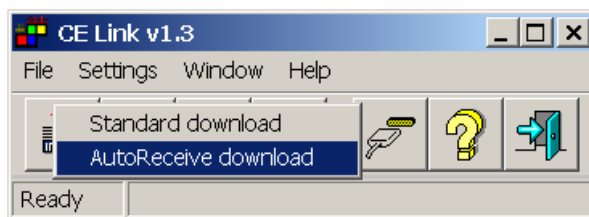

Fig. 67. Auto receive download mode

- After the file name for storing downloaded data is defined the 'Auto receive mode' window will appear.

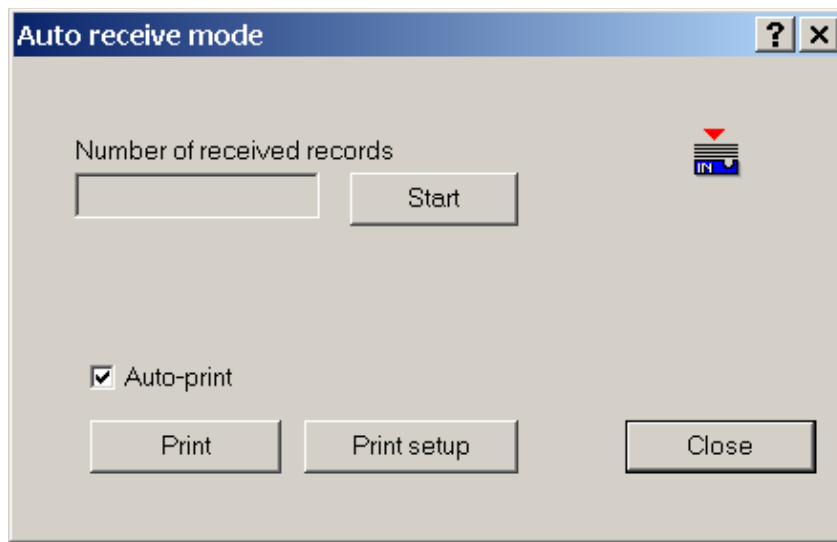

Fig. 68. Auto receive download mode

- Before starting of the autotest you should press Start button in the Auto receive mode window. There is a counter for the number of received records since Start pressed.
- Auto receive mode enables two different ways for printing received results:
 - Auto print (automatically prints the results after each reception)
 - Manual print (print results after Print button in the Auto receive mode is pressed)
- At the end of auto download you should press Stop button in the Auto receive mode window.

7.4. OPEN DATA FILE

To open one of downloaded data files press "Open data file" button in basic screen. Window for file selection will be displayed.

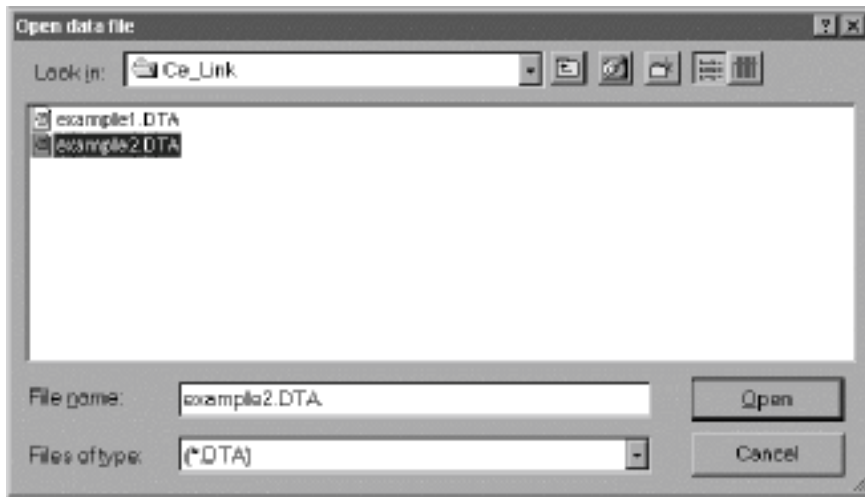

Fig. 69. Selecting file “example2. DTA”

After selecting the desired data file and pressing Open downloaded data will be displayed in the table form. Table organization is same as in instruments internal memory; from Device 1 to last Device (max 255) with saved results, - see chapter 5.2. Memorizing of results.

Time	Dev	Mem	Description	Result 1	Result 2	Result 3	Result 4	Result 5
18:05:00 - 13:21:45	1	0	Leakage current	I: 0.05mA		t: 3s	L: 1.00mA	
18:05:00 - 13:21:54	1	1	Leakage current	I: 0.05mA		t: 5s	L: 1.00mA	
18:05:00 - 13:22:00	2	2	Leakage current	I: 0.05mA		t: 2s	L: 1.00mA	
18:05:00 - 13:22:09	3	3	Leakage current	I: 0.05mA		t: 5s	L: 1.00mA	
18:05:00 - 13:22:21	4	4	Leakage current	I: 0.05mA		t: 8s	L: 1.00mA	
18:05:00 - 13:24:54	5	5	Rao 500V	R: 329.90Ohm	U: 530V	t: 0s	RL: 3277.0M0hm	
22:05:00 - 11:48:23	2	0	Rao 500V	R: 1.0070hm	U: 144V	t: 4s	RL: 32.770M0hm	
22:05:00 - 11:48:47	1	1	Rao 500V	R: 1.0070hm	U: 144V	t: 3s	RL: 32.770M0hm	
22:05:00 - 11:48:57	2	2	Leakage current	I: 0.13mA		t: 3s	L: 1.00mA	
22:05:00 - 11:49:04	3	3	Leakage current	I: 0.13mA		t: 3s	L: 1.00mA	
22:05:00 - 11:49:18	4	4	Cont. Currentflow	R: 0.0240hm	I: 11.3A	U: 0.264V	t: 3s	RL: 0.0100hm
22:05:00 - 11:49:24	5	5	Cont. Currentflow	R: 0.0200hm	I: 11.0A	U: 0.205V	t: 4s	RL: 0.0100hm
22:05:00 - 11:49:33	6	6	With high voltage	I: 0.2mA	U: 1.000V	t: 3s	L: 1.0mA	
22:05:00 - 11:49:43	0	0	With prog. high voltage	I: 0.2mA	U: 1.000V	t: 10s	L: 2.0mA	
22:05:00 - 11:49:50	1	1	With high voltage	I: 0.2mA	U: 1.000V	t: 3s	L: 1.0mA	

Fig. 70. Data file window

In the table all failed measurements will be marked by red color. By using search button (see table 2) the user can easily jump from one to another failed measurement.

For table editing (for example if a measurement result is saved during measuring under wrong device index by mistake) standard utilities are available, such as copy, cut, paste, delete etc. All those operations affect selected row.

After table editing device and memory numbers can be rearranged from top to bottom by pressing Rearrange button.







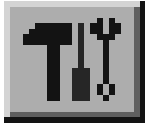

	<p>Copy: Copies selected row.</p> <p>Shortcut key: Ctrl+C, Alt E + C</p>		<p>New / Edit Device: Adds description, edits device or barcode number or creates new device.</p> <p>Shortcut key: Alt E + N</p>
	<p>Cut: Cuts selected row.</p> <p>Shortcut key: Ctrl+X, Alt E + U</p>		<p>Insert / Edit comment: Inserts row with comment or edit existed comment.</p> <p>Shortcut key: Alt E + O</p>
	<p>Paste: Paste last cut or copied row.</p> <p>Shortcut key: Ctrl+V, Alt E + P</p>		<p>Save table: To save edited table.</p> <p>Shortcut key: Alt F+S</p>
	<p>Delete: Deletes selected row (after delete paste is not available).</p> <p>Shortcut key: Delete, Alt E + S</p>		<p>Export to clipboard: Exports selected rows on clipboard.</p> <p>Shortcut key: Alt E</p>
	<p>Mark / Unmark row: Marks or unmarks important row.</p> <p>Shortcut key: Alt E + D</p>		<p>Print: Prints open data fille.</p> <p>Shortcut key: Alt F + P</p>
	<p>ReArrange numbers: Rearranges from top to bottom device and memory numbers (often used after editing table).</p> <p>Shortcut key: Alt E + R</p>		<p>Main window: Jumps to main window without closing.</p> <p>Shortcut key: Alt F + M</p>
	<p>Search: Jumps on next row with error value.</p> <p>Shortcut key: Alt E + S</p>		<p>Close: Closes window and return to main window.</p> <p>Shortcut key: Alt F + C</p>

Table. 2. Fast access buttons

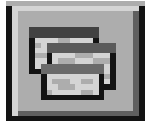
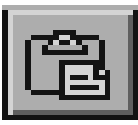
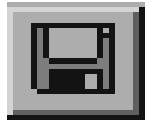
The user can insert a new row with comment or edit existing comments (Insert / Edit comment button). To export measurement to other programs, the user can use Export to clipboard option (Copy / Paste commands do not work with Windows clipboard). Note: only selected rows will be exported.

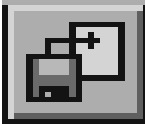
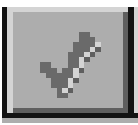
7.5. PRINTING DOCUMENTS

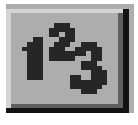
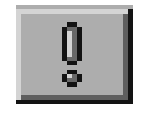
7.5.1 PRINTING SELECTED ROWS

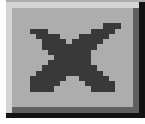
Selected rows can be printed following this steps:

1. Select rows to be printed (use Shift + left mouse button for selecting subsequent records to record or Ctrl + left mouse button for selecting one row by one).
2. Choose Window for printing option in File men.
3. To create header select Define header in File menu.
4. Choose Print form Print menu.

Header options

- define header height,
- include bitmap file (user logo - in our example windows clouds.bmp),
- underline header,
- write header text (first line above bitmap, other five under), for every line set appropriate font or insert commands like system date, time, serial number, current page, total pages,
- load or save created header,
- preview created document.

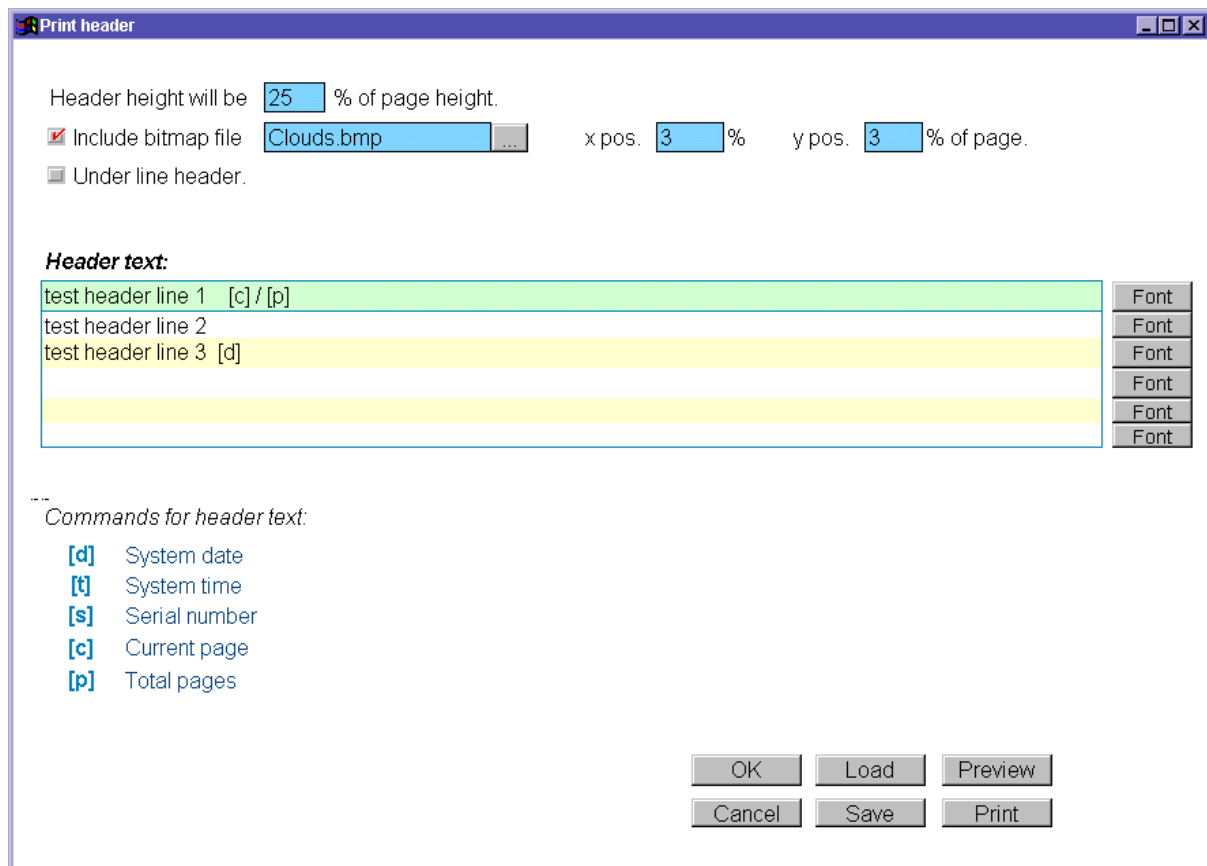

Fig. 71. Creating Header for printed documents

Our example will create header below.

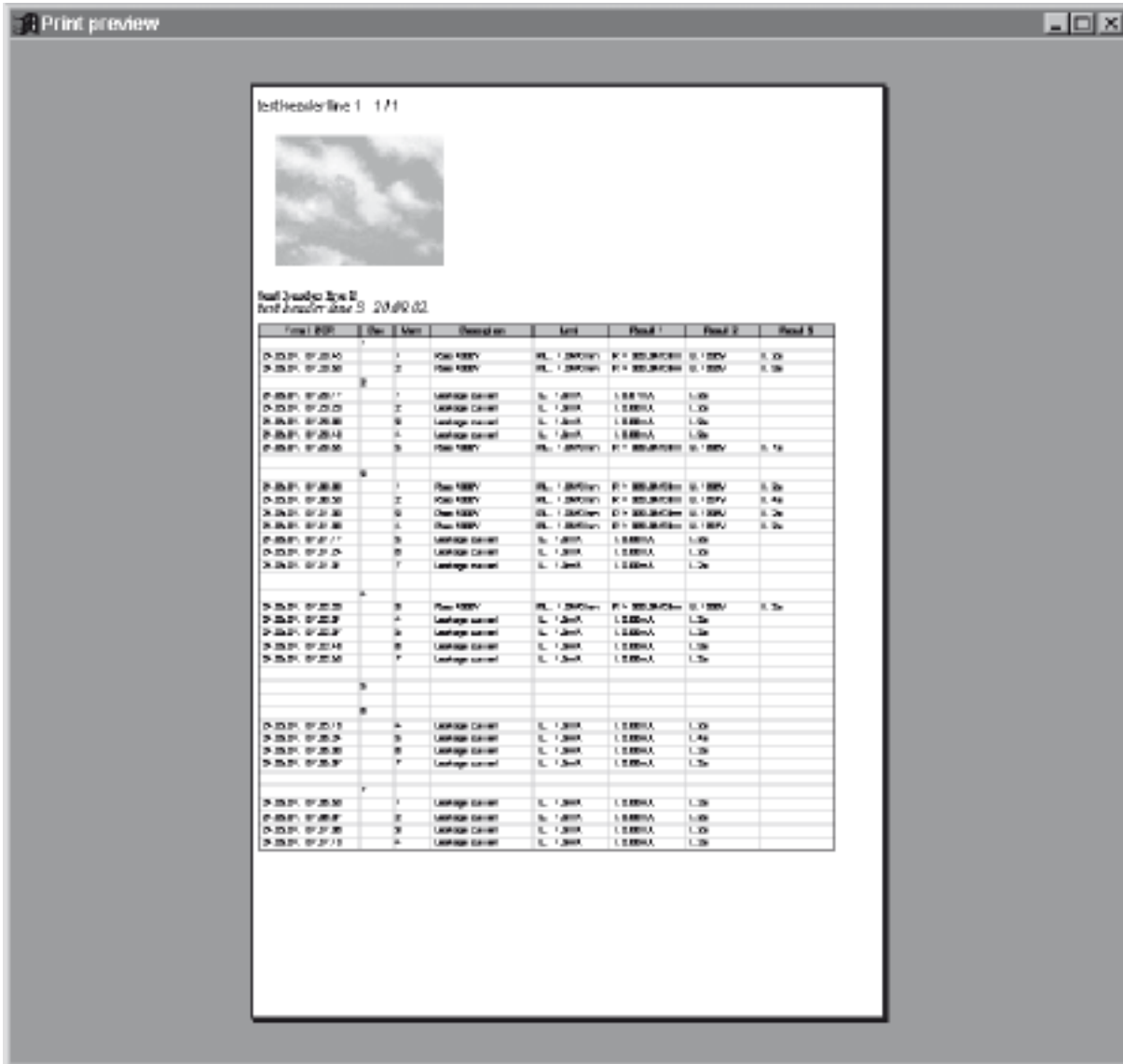

Fig. 72. PRINT preview

7.5.2 PRINT SEPARATELY

Print separately function prints each measured device results to its own document. It is intended to print separate reports for each tested object (production line testing).

7.6. HEADER PROGRAMMING

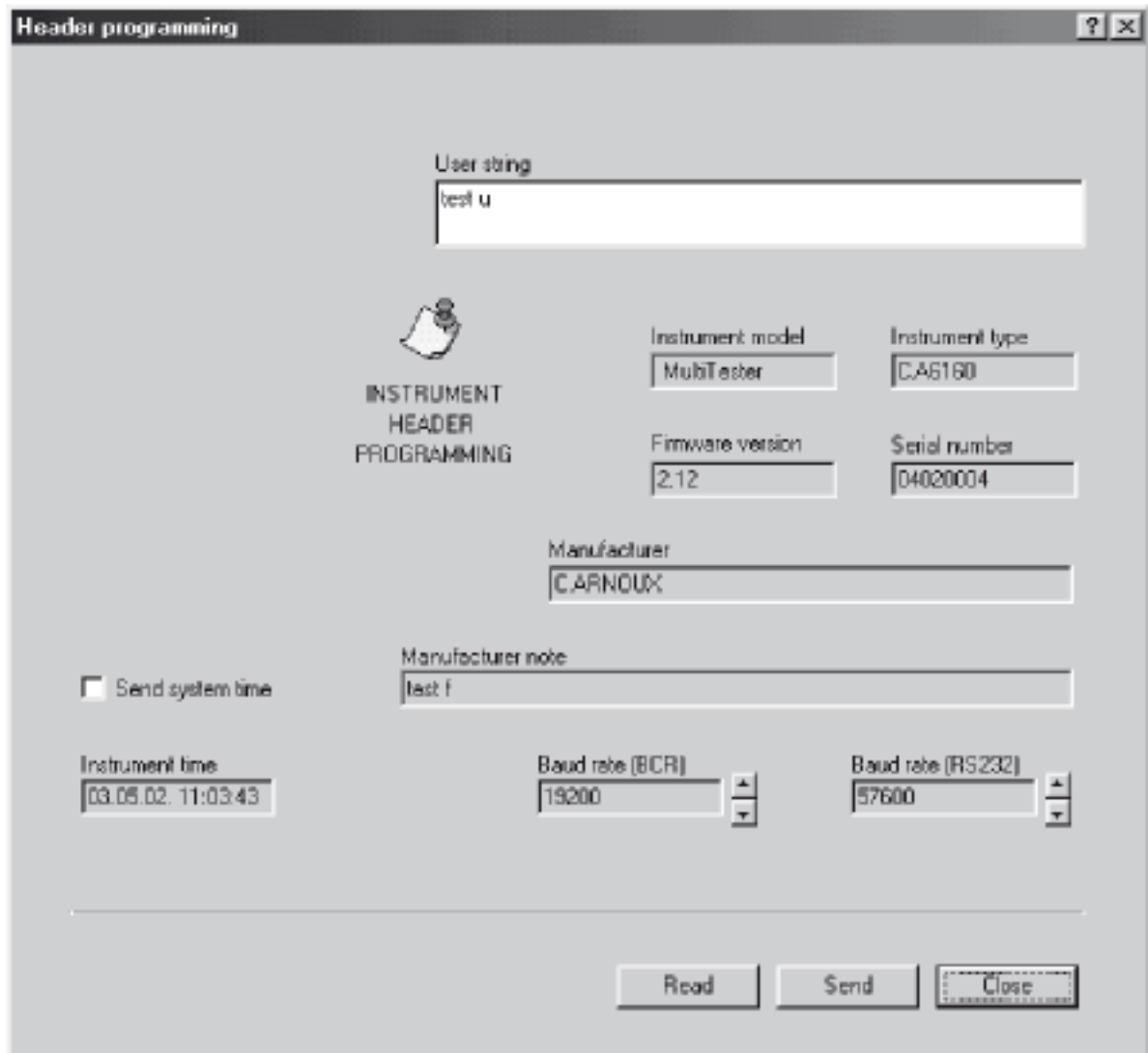

Fig. 73. Header programming window

This window represents info window for your instrument (called header). To see instrument header the instrument has to be connected to PC.

User can change "User string" (max 48 characters), send system time (time and date set on the PC).

It is possible to change **User string** only in this way. Instrument time and date or baud rates can be edited directly on instrument without using software (see instruction in chapter 5.5. System configuration).

7.7. SEQUENCE EDITOR

Basic point of **Sequence editor** is displayed in chapter 4.10. AUTOTEST. The user will use **Sequence editor** to create desired sequences or to edit existing sequence on the instrument. Max. number of steps in one sequence is 50, including programmed pause, messages, barcode reader sequence and sound signals. Max. number depends on combination of included function in current example.

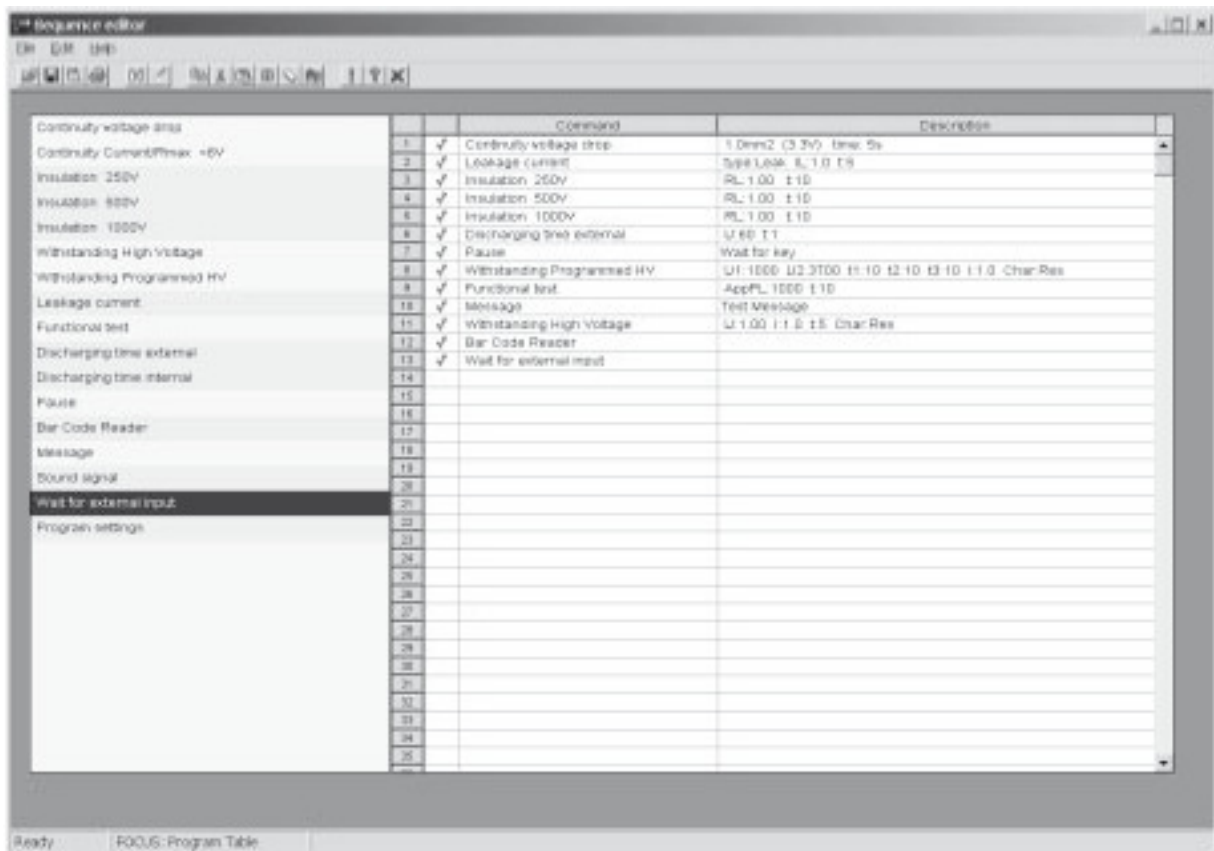
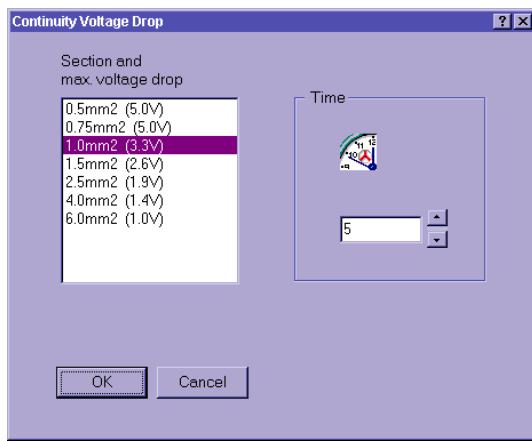

Fig. 74. Sequence editor window

Two main parts of Sequence editor are **Command table** and **Program table**. Command table contains all commands that can be executed on Appliance Multitester.

User creates his sequence by selecting command one by one, and assigning them into program table using **Get command** key or by double clicking the desired command. For all selected commands limit values have to be set by using **Edit parameters** key.



Voltage drop Parameter window

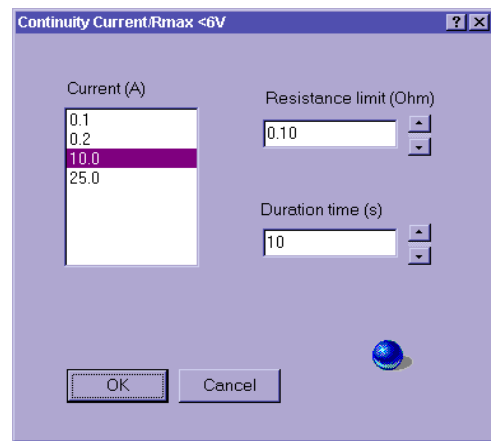

Continuity Current Parameter window

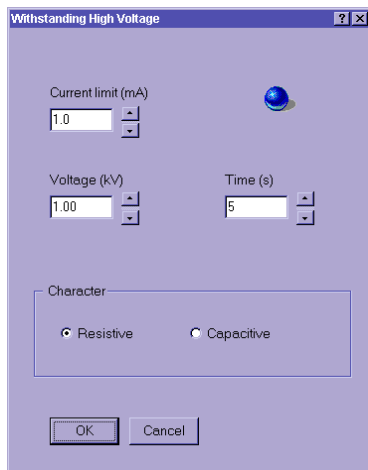

High Voltage Parameter window

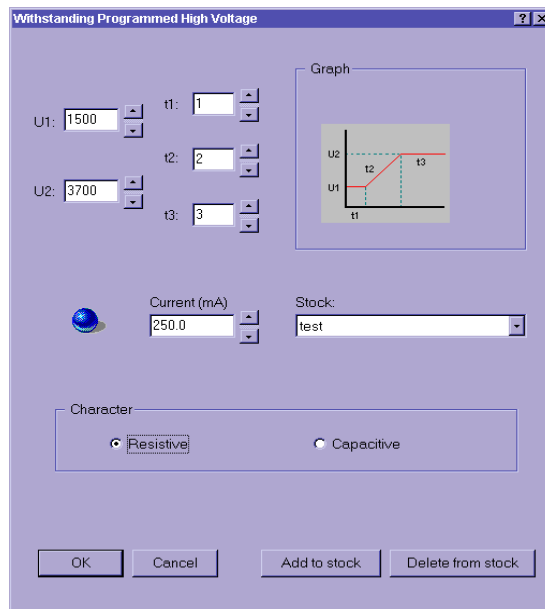

Programed High Voltage Parameter window

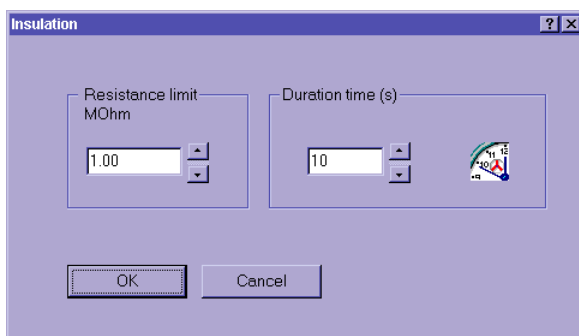

Insulation Parameter window

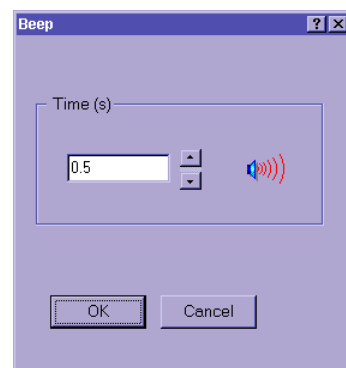

Sound Parameter window

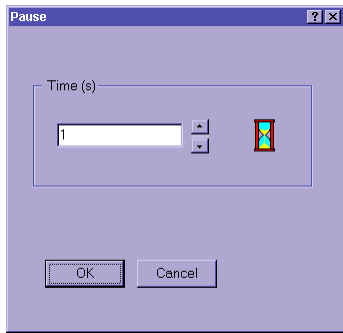

Pause Parameter window

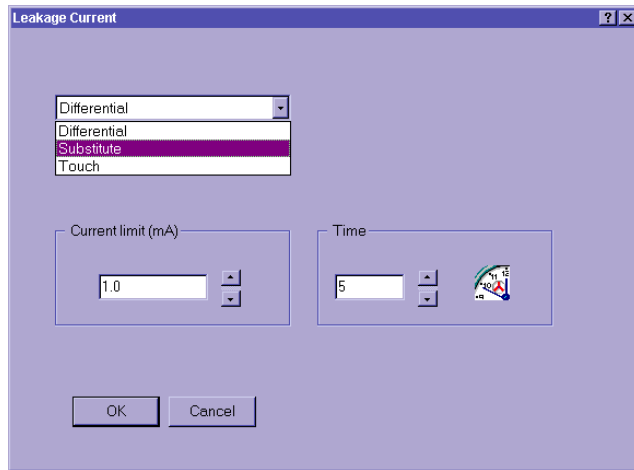

Leakage Current Parameter window

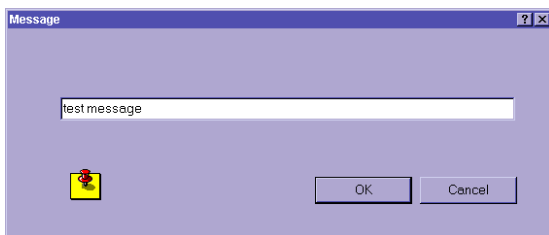

Message Parameter window

Fig. 75. Parameter windows

To set program name in **Command table** select **Program name**.

In this dialog box user can also enable:

- pause (0 s – 5 s) between each test of the sequent,
- saving of measurement results,
- increment device number for successive sequence results,
- auto send each sequence results to PC (suitable for automate of production lines).
- auto repeat (autotest sequence is circularly repeated after defined Pause 0-5 sec).

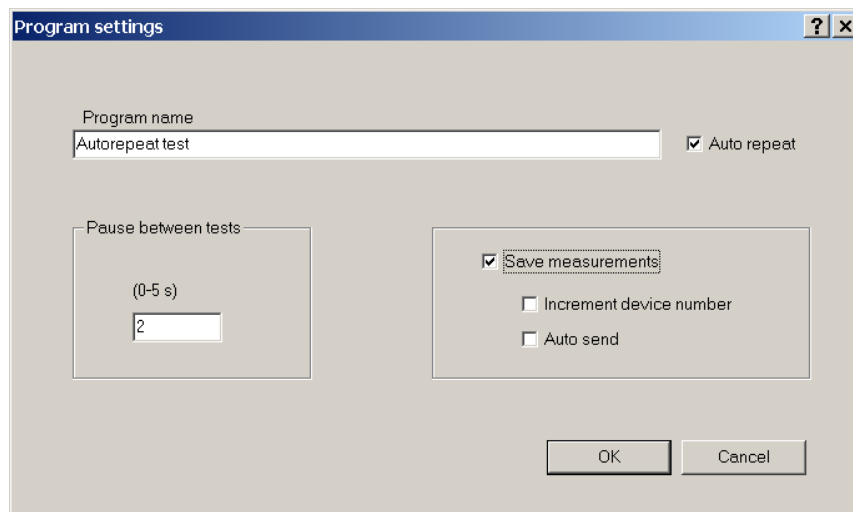

Fig. 76. Program name – definition window

Created sequence can be sent to Appliance Multitester, and saved to disc with extension SQC.



	<p>List of instrument programs: Reads, delete and sends sequence to instrument.</p> <p>Shortcut key: Alt F + D</p>		<p>Clear row data: Clears only data, not whole row.</p> <p>Shortcut key: Alt S + P</p>
	<p>Get command: Copies selected command from command table to program table.</p> <p>Shortcut key: Alt F + O</p>		<p>Insert empty row: Inserts an empty row at selected row (for a new command).</p> <p>Shortcut key: Alt H</p>
	<p>Edit parameters: Set limits and other parameters for selected type of measurement.</p> <p>Shortcut key: Alt F + H</p>		

Table. 3. Fast access buttons

8. TO ORDER

- **C.A 6160 APPLIANCE MULTITESTER (GB)** ----- P01145801A
- **C.A 6160 APPLIANCE MULTITESTER (EURO)** ----- P01145801

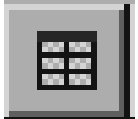
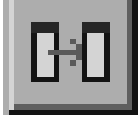
Standard supply :

- 1 power supply lead (Euro or GB)
- 2 dielectric test guns (probes) with cable 2m
- 2 insulation test leads, 3m (1 red, 1 black)
- 4 crocodile clips (2 red, 2 black)
- 2 test probes (1 red, 1 black)
- 4 continuity test leads, 2.5m (2 red, 2 black)
- 1 discharge time cable (EURO or GB)
- 1 bag for the accessories
- 5 user's manuals (5 languages)

■ **ACCESSORIES**

- PC software + communication cable DB9F-DB9F ----- P01101996
- Remote control probe ----- P01101916
- Warning lamps (green / red) ----- P01101917
- 2 dielectric test guns with cable 6m ----- P01101918
- 1 adapter DB9M/DB9F ----- P01101941

■ **SPARE PARTS**

- 1 bag for accessories ----- P01298061A
- 2 dielectric test guns (probes) with cable 2m ----- P01101919
- 2 insulation test leads, 3m (1 red, 1 black) ----- P01295097
- 2 crocodile clips (1 red, 1 black) ----- P01295457Z
- 2 test probes (1 red, 1 black) ----- P01295458Z
- 2 continuity test leads, 2.5m (1 red, 1 black) ----- P01295236
- 1 discharge time cable (EURO) ----- P01295141
- 1 discharge time cable (GB) ----- P01295142
- 1 power supply lead (EURO) ----- P01295234
- 1 power supply lead (GB) ----- P01295235
- 1 RS232 communication cable DB9F-DB9F ----- P01295172
- 10 fuses 16A-250V 6x32T ----- P01297086
- 10 fuses 2.5A-250V 5x20T ----- P01297085



06 - 2014

Code 691030A02- Ed. 7

DEUTSCHLAND - Chauvin Arnoux GmbH
Straßburger Str. 34 - 77694 Kehl / Rhein
Tel: (07851) 99 26-0 - Fax: (07851) 99 26-60

ESPAÑA - Chauvin Arnoux Ibérica SA
C/ Roger de Flor N° 293, Planta 1
08025 Barcelona
Tel: +34 902 20 22 26 - Fax: +34 93 459 14 43

ITALIA - Amra SpA
Via Sant'Ambrogio, 23 - 20846 MACHERIO (MB)
Tel: +39 039 245 75 45 - Fax: +39 039 481 561

ÖSTERREICH - Chauvin Arnoux Ges.m.b.H
Slamastrasse 29/2/4- 1230 Wien
Tel: +43 1 61 61 9 61 - Fax: +43 1 61 61 961-61

SCANDINAVIA - CA Mätssystem AB
Box 4501 - SE 18304 TÄBY
Tel: +46 8 50 52 68 00 - Fax: +46 8 50 52 68 10

SCHWEIZ - Chauvin Arnoux AG
Moosacherstrasse 15 - 8804 AU / ZH
Tel: +41 44 727 75 55 - Fax: +41 44 727 75 56

UNITED KINGDOM - Chauvin Arnoux Ltd
Unit1 Nelson Court - Flagship Square- Shaw Cross Business Park
DEWSBURY - West Yorkshire - WF12 7TH
Tel: +44 1924 460 494 - Fax: +44 1924 455 328

MIDDLE EAST - Chauvin Arnoux Middle East
P.O. BOX 60-154 - 1241 2020 JAL EL DIB (Beirut) - LEBANON
Tel: +961 1 890 425 - Fax: +961 1 890 424

CHINA - Shanghai Pu-Jiang - Enerdis Instruments Co. Ltd
3 F, 3 rd Building - N° 381 Xiang De Road - 200081 SHANGHAI
Tel: +86 21 65 21 51 96 - Fax: +86 21 65 21 61 07

USA - Chauvin Arnoux Inc - d.b.a AEMC Instruments
200 Foxborough Blvd. - Foxborough - MA 02035
Tel: +1 (508) 698-2115 - Fax: +1 (508) 698-2118

<http://www.chauvin-arnoux.com>

190, rue Championnet - 75876 PARIS Cedex 18 - FRANCE
Tél. : +33 1 44 85 44 85 - Fax : +33 1 46 27 73 89 - info@chauvin-arnoux.fr
Export : Tél. : +33 1 44 85 44 86 - Fax : +33 1 46 27 95 59 - export@chauvin-arnoux.fr