

metrix

User's manual

OX 803B

Oscilloscope 40 MHz
Dual Trace

metrix

**CHAUVIN
ARNOUX**
GROUP

190, rue Championnet
75876 PARIS CEDEX 18
Tél. : 01 44 85 44 85

Mesurer pour mieux Agir

OX 803B - 40 MHz

OX 803B

**40 MHz-DUAL TRACE
OSCILLOSCOPE**

User's manual

C O N T E N T S

1. General instructions	5
1.1. Safety Measures and Precautions	5
1.1.1. Before Use	5
1.1.2. During Use	5
1.1.3. Symbols	5
1.1.4. Precautions	5
1.2. Guarantee	6
1.3. Maintenance	6
1.4. Unpacking & Re-packing	6
2. Device description	7
3. Putting into service	8
3.1. AUTOSET	8
4. Functional description	9
4.1. Vertical Channels	9
4.2. Display Modes	10
4.3. Timebase	10
4.4. Triggering	11
4.5. Delay	12
4.6. Other Functions	13
5. Applications	14
5.1. Probe Adjustment using the Calibration Signal	14
5.2. Amplitude and Frequency Measurements	15
5.3. Phase Difference Measurement	16
5.3.1. In Dual-Curve Mode	16
5.3.2. In XY Mode	16
5.4. Video Signal Display	17
5.4.1. Examining a TV Line	17
5.4.2. Detailed Examination of Burst	18
5.4.3. Examination of a TV Frame	18

INDEX

A	P
Accessories 25	Peak-to-peak trigger 11
Amplitude measurements 14	Phase shift measurement 16
Automatic triggering 11	Power supply 23
AUTOSET 8, 22	PROBE ADJUST 13, 14
	Probes 14
C	Programming kit 25
Calibration signal, 22	
COMPONENT TESTER 13, 19, 22	S
	Safety 6, 23
D	
Decalibration 9, 10	T
DELAY 12	Technical characteristics 20
Display modes 10	Temperature, 24
	Timebase 10, 20
E	Timebase generator 19
EMC 24	TRACE ROTATION, 13
External synchronisation	Trigger 11, 21
	Trigger delay 12
F	Trigger level 11
Frequency measurements 15	Trigger slope 11
Fuse	Trigger source 11
	Trigger source coupling 12
G	TV 17
Guarantee 7	
H	V
HOLDOFF 10	Vertical channels 9
Horizontal expansion 9	Vertical deflection
Horizontal framing 9	Vertical sensitivity 9
	Video signal, 17
I	
Input coupling 9	X
	XY Mode 16
M	
Maintenance 7	Z
	Z Modulation 13, 22

OSCILLOSCOPE - 40 MHz

CONTENTS

5.5. Component Tester Application	19
5.5.1. Diode Characteristic Display	19
5.5.2. Diode with Direct Resistance	19
5.6. Timebase Generator Output	19
6. Technical specifications	20
6.1. Vertical Deflection (CH1 and CH2)	20
6.2. Horizontal Deflection (Timebase CH1 and CH2)	21
6.3. Trigger System	21
6.4. Component Tester	22
6.5. Signal de calibration	22
6.6. Z Modulation	22
6.7. Autoset Mode	22
6.8. Safety	23
6.9. General Information	23
6.9.1. Mechanical Characteristics	23
6.9.2. Power Supply	23
6.9.3. Cathode Tube	23
6.10. Environment	24
6.10.1. Temperatures	24
6.11. Compatibilité électromagnétique	24
7. Accessories and options	25
7.1. Accessories	25
7.1.1. Supplied with Device	25
7.1.2. Supplied as Options	25
7.2. Other Oscilloscope Models	25
7.3. Optional Programming Kit	25
INDEX	26

OSCILLOSCOPE - 40 MHz

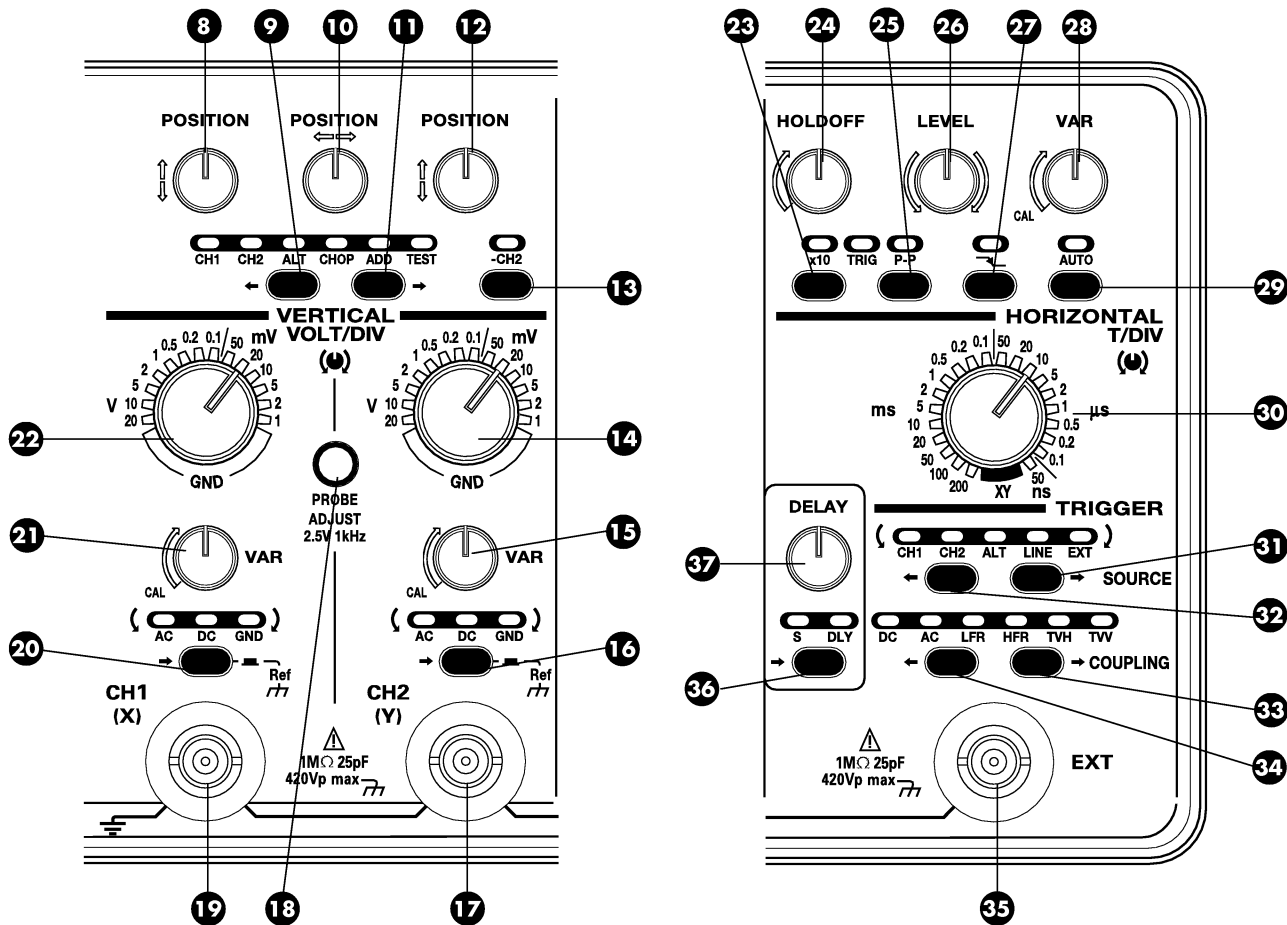
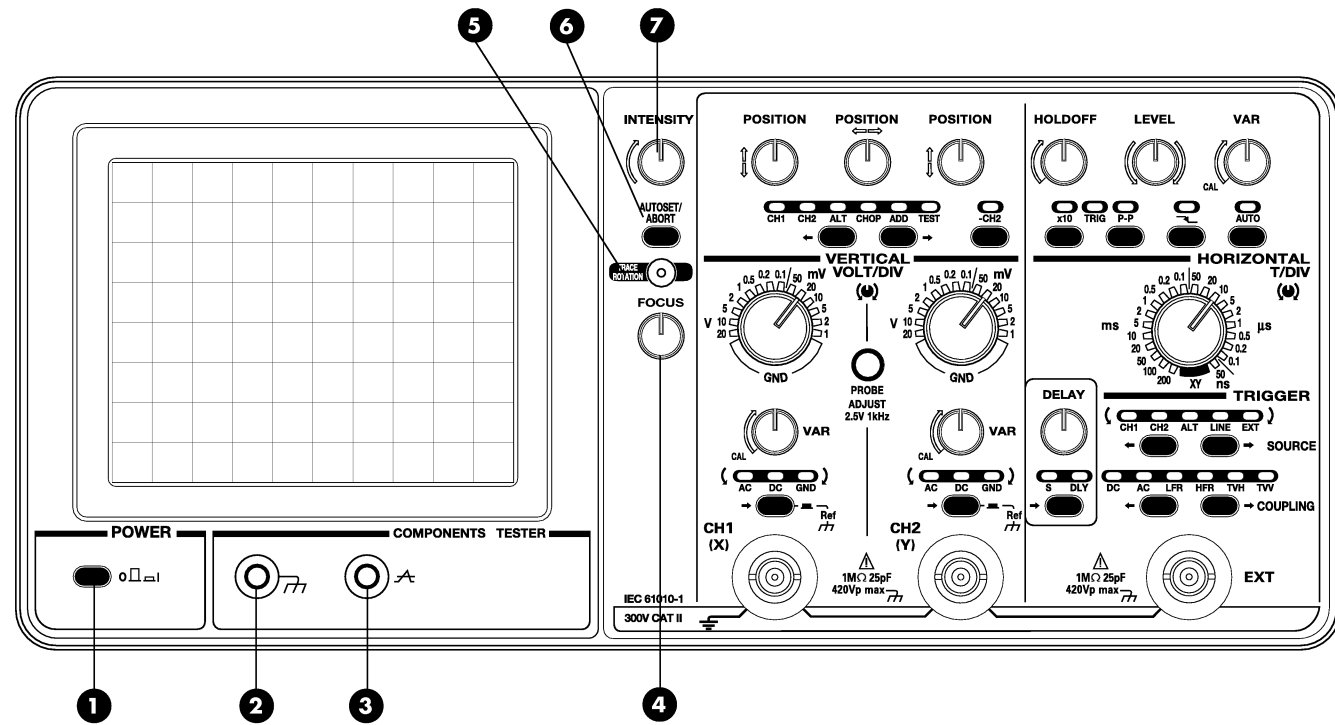

7. Accessories and Options

7.1. Accessories

7.1.1. Supplied with Device

Operating instructions

Ceramic fuse, 2.5 A time-delay, located inside the device in a recess in the cathode tube support part

Mains power lead

AT 0090

7.1.2. Supplied as Options

BNC cable, male/male

BNC cable, male/male banana

BNC adapter, male/4-mm banana

Passive reducing probe 10 MΩ/12 pF, 1/10 and 1/1

Reducing probe 1/10, 250 MHz, 10 MΩ/12 pF

Reducing probe 1/100, 200 MHz, 100 MΩ/5 pF, 2 kV max.

Differential probe x20 x200, 40 MHz, 700 V max.

PA 2249C48

HA 0844

PA 1296

HX 0003

HX 0004

HA 1317

MX 9003

GB

7.2. Other Oscilloscope Models

Version with two probes HX 0003

Version with remanent tube (GM phosphorus)

7.3. Optional Programming Kit

The oscilloscope can be equipped with a serial link for remote control purposes.

This programming kit, HA 1255, comprises an RS 232 interface, a serial cable, and a diskette containing the Labwindows drivers and a driver software program representing a virtual oscilloscope front panel.

This software can be used to change all the parameters of the device.



We reserve the right to change specifications and prices in the context of technological developments that make such changes necessary.

6. Technical Specifications (continued)

6.10. Environment

6.10.1. Temperatures

Reference temperature:	+ 18°C to + 28°C
Use temperature:	+ 10°C to + 40°C
Operating temperature:	0°C to + 50°C
Storage temperature:	-20°C to + 70°C
Relative humidity:	< 80 % at + 40°C

6.11. Electromagnetic compatibility

Emission:	according to EN 50081-1, 1992
Immunity:	according to EN 50082-1, 1997
Influence parameters:	
VERTICAL:	parasitic deflection < ± 2 div. under the effect of an 80 MHz to 1 GHz RF field or under directed RF interference of 150 kHz to 80 MHz
TRIGGER:	triggering possible under the effect of rapid burst transients or electrostatic discharges.

1. General Instructions

This device complies with the IEC 61010-1, 1993, safety standard concerning electronic measuring instruments. For your own safety and that of the device, you must follow the instructions given in this manual.

1.1. Safety Measures and Precautions

1.1.1. Before Use

- This device was designed for indoor use, in an environment with Pollution Index 2.
- It can be used for measurements on Overvoltage Category II installations, at a maximum of 300 V.
- Definition of categories:
 - Installation Category I: Installation Category I includes equipment used to connect circuits in which measurements have been taken to limit overvoltages to appropriate low levels.
 - Installation Category II: Power-consuming equipment powered by a fixed installation.
 - Installation Category III: Fixed-installation equipment.
 - Installation Category IV: Equipment used at energy sources.
- Check that your electrical distribution network is within the 96-264 V (rms) range.



A replacement fuse must be identical to the original fuse. The fuse is located inside the device, in a recess in the cathode tube support part.

GB

- Earth all accessible metal parts (including the work table).
- Use only the three-wire mains power lead (two phase wires, and one earth wire), and connect it to the earthed socket.

1.1.2. During Use



- Use measurement probes that are in good working order.
- Select appropriate vertical sensitivity ratings and timebases for the measurement, or use the Autoset function.
- Select appropriate vertical sensitivity ratings and timebases for the measurement, or use the Autoset function.
- Read all the notes preceded by the  symbol carefully.



Failure to observe warnings and/or user instructions may result in damage to the device and/or its components.

1.1.3. Symbols

The following symbols are used:

-  Warning: Refer to the instruction manual. Incorrect use may result in damage to the device or its components.
-  Danger, high voltage: Presence of dangerous voltage levels, with risk of electric shock.
-  Earth terminal

1.1.4. Precautions

Before opening the device, always disconnect it from the mains power supply and measuring circuits.



Certain internal capacitors may store a dangerous potential, even when the device has been disconnected from the power supply.

Any adjustment, maintenance, or repair carried out on the oscilloscope with power on must be performed by qualified personnel only.

1. General instructions

1.2. Guarantee

This equipment is guaranteed against any material defect or manufacturing vice, in compliance with the general conditions of sale. During the guarantee period, defective parts are replaced, although the manufacturer reserves the right to repair or replace the product, at his discretion. When equipment is returned to the after-sales service department or to a regional agent, the customer is responsible for the cost of outbound transport.

The guarantee is not applicable in the following cases:

- Repair following incorrect use of the equipment or use of the equipment in association with an incompatible device.
- Modifications applied to the equipment without explicit authorisation from our technical department.
- Repairs carried out by a person not having company approval.
- Adaptation to a specific application not provided for in the equipment specification or operating manual.

If the device fails to operate, check the following before returning it under guarantee:

- Power lead is not disconnected,
- Fuse is not inoperative,
- You have read and understood the functional description in Paragraph 4,
- Test leads are in good working order.

The contents of this manual may not be reproduced in any form whatsoever without our consent.

1.3. Maintenance

Please contact your regional agent if you have a problem concerning maintenance, replacement parts, the guarantee, etc.

Your agent will take prompt action on any order for replacement parts, or provide a rapid repair or equipment re-calibration service.

1.4. Unpacking & Re-packing

All the equipment was checked electrically and mechanically before despatch.

All necessary precautions have been taken to ensure that the instrument reaches you undamaged.

Nonetheless, it is advisable to perform a rapid check to look for any damage that might have been caused in transit.

If such damage is detected, immediately register the usual reservations with the haulage company.



If returning the equipment, use the original packaging if possible, and indicate the reasons for its return as clearly as possible on a note enclosed with the equipment.



Our products are patented. The logos are registered. We reserve the right to change product specifications or prices in the context of technical developments that make such changes necessary.

6. Technical Specifications (continued)

6.8. Safety

IEC 61010-1 (NFC 42-020-1993):

- Insulation: Class 1
- Pollution Index 2
- Indoor use, altitude < 2000 m
- Input overvoltage category CAT II (300 V)
- Power supply overvoltage category CAT II (264 V (rms) max.)

6.9. General Information

6.9.1. Mechanical Characteristics

Stackable device with handle used as support stand

Dimensions: see figure below

Mass: 6.3 kg

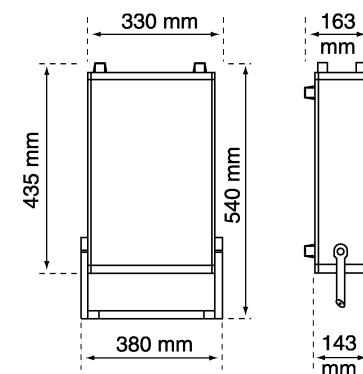

GB

Packing:

Dimensions: 550 mm x 460 mm x 280 mm

Mass: 7.7 kg

6.9.2. Power Supply

Network: Universal mains 96 to 264 V rms, frequency 48/400 Hz

Removable mains lead

Winder with plug support at rear of device

Consumption: 35 W maximum

6.9.3. Cathode Tube

Type: Rectangular with internal graticule, 13 cm diagonal

Graticule: 8 vertical divisions with 5 subdivisions

10 horizontal divisions with 5 subdivisions

1 division = 1 cm

Screen: GY average persistence phosphorus

Trace: Trace rotation adjustment

Focus adjustment

Luminous intensity adjustment

Acceleration voltage: 2 kV approx.

Contrast screen: green

6. Technical Specifications (continued)

Trigger delay coefficient:	
Sweep time rating	Delay range (approximate)
50 ns/div.	0.5 μ s to > 2 μ s
0.1 μ s/div.	0.5 μ s to > 2 μ s
0.2 μ s/div.	0.5 μ s to > 2 μ s
0.5 μ s/div.	0.5 μ s to > 5 μ s
1 μ s/div.	1 μ s to > 10 μ s
2 μ s/div.	2 μ s to > 20 μ s
5 μ s/div.	5 μ s to > 50 μ s
10 μ s/div.	10 μ s to > 100 μ s
20 μ s/div.	20 μ s to > 200 μ s
50 μ s/div.	50 μ s to > 0.5 ms
100 μ s/div.	100 μ s to > 1 ms
200 μ s/div.	200 μ s to > 2 ms
500 μ s/div.	500 μ s to > 5 ms
1 ms/div.	1 ms to > 10 ms
2 ms/div.	2 ms to > 20 ms
5 ms/div.	5 ms to > 50 ms
10 ms/div.	10 ms to > 100 ms
20 ms/div.	20 ms to > 200 ms
50 ms/div.	50 ms to > 500 ms
100 ms/div.	100 ms to > 1 s
200 ms/div.	100 ms to > 1 s

6.4. Component Tester

Output:	via 4-mm banana sockets
Voltage:	18 V peak-peak
Current:	9 mA max.
Waveform:	10 ms sawtooth, frequency 75 Hz approx.
Protection:	264 V (rms)

6.5. Calibration Signal

Waveform:	square
Amplitude:	0 +2.5 V \pm 1 %
Frequency:	1 kHz \pm 1 %

6.6. Z Modulation

Input:	BNC on back panel
Sensitivity:	TTL level for all-or-nothing modulation 1.3 V < level < 2.6 V for gradual modulation
TTL high level:	on
TTL low level:	off
Input resistance:	2 k Ω
Maximum frequency:	4 MHz
Maximum voltage:	\pm 20 V (dc)

6.7. Autoset Mode

Signal search time 3 s approx.
 25 Hz \leq signal frequency \leq 35 MHz
 15 mV p-p \leq amplitude without probe \leq 160 V p-p
 Automatic switching in CHOP mode for T/div. \leq 0.5 ms/div.
 In the case of two channels, trigger occurs on the CH1 signal.
 For asymmetric signals (duty cycle \neq 50%). The choice of trigger edge favours display of the shorter alternance.

2. Device Description

Your portable oscilloscope is a two-channel device. Its technology was designed to satisfy even the most demanding user.

Specifications

Your oscilloscope has the following features:

- autoset,
- 2 channels at 40 MHz,
- High input dynamic range: 1 mV to 20 V per division,
- Timebase range extended to 50 ns/div. (21 positions),
- Trigger up to 75 MHz,
- Trigger delay function,
- Input voltage up to 300 V (overvoltage Category II) with impedance 1 M Ω / 25 pF,
- Remote control option (HA 1255 programming kit),
- Adjustment and calibration via Digital-to-Analogue Converter.

Reliability

Your oscilloscope has enhanced reliability because of:

- Use of surface-mount devices and LSI integrated circuits,
- Complete microprocessor control,
- Front panel independent from measuring circuits,
- Internal switching via miniature relays and electronic switches,
- Digital adjustments.

Ergonomic







- The device is quick to open.
- All components are accessible without removing the printed circuit board.
- The housing has non-skid feet.
- During operation, the carrying handle folds down for use as a tilting support stand without interfering with access to the front-panel controls.
- The control devices are grouped in functional blocks.
- Functions are activated by simply pressing transient keys.
- Active functions are shown by indicator lights (LEDs).
- The last configuration used is stored in memory, and automatically restored when the device is switched on again.

GB

3. Putting into Service

 Observe the safety instructions given in Chapter 1.

► Position the controls as shown in the table below:

POSITION OF BUTTONS			
INTENSITY	POSITION		HOLDOFF
			
			

1  ► Press down the POWER key. The last configuration in memory is restored.

19   **17** ► Apply a signal to CH1 or CH2.

3.1. AUTOSET

6  ► Press the AUTOSSET key. Operator access to the controls is locked out during AUTOSSET.

There are two stages of Autoset operation:

STAGE 1 : Automatic search for the presence of a signal on each channel, followed by vertical and horizontal coefficients of deflection for optimum display (AUTOSSET operating limits, see Page 21: Technical Specifications).

STAGE 2 : Assisted manual search, to make the VOLT/DIV. and T/DIV. ratings displayed correspond to those found by Autoset.

- For VOLT/DIV., the indicator lights (AC or GND) show the direction of the rotation to be performed.

When the lights are off, the VOLT/DIV. switches are in the correct position.

- For T/DIV., the source indicator lights, (CH1 or EXT), show the direction of the rotation to be performed.

When the lights are off, the T/DIV. switch is in the correct position.

If the searching order is different from the order shown, the front panel becomes active again when the last switch is positioned correctly. Normal operating mode is then resumed.

 **Stage 2 may be omitted, and Autoset/Abort may be pressed instead. The ratings then correspond to the position of the VOLT/DIV. and T/DIV. buttons again. This action can cause the signal to be lost.**

order of the search does not matter.

► Final state after AUTOSSET:

- AC coupling for active channels; otherwise, coupling does not change.
- -CH2 never modified
- x10 switched off if active
- PTP activated
- Auto TRIGGER
- DELAY deactivated
- DC source coupling
- Trigger source assigned

6. Technical Specifications (continued)

6.2. Horizontal Deflection (Timebase CH1 and CH2)

Sweep coefficient:	Ranges: 50 ns/div. to 200 ms/div. ± 3 % (21 positions, sequences 1, 2, and 5)	
Variable coefficient:	Multiply ms/div. rating by 1 to 2.5 (horizontal contraction of signal) Uncalibrated position: source indicator light flashes Calibrated position (left stop): source light on	
x10 Expansion:	Accuracy ± 5 % (can reach 10 ns/div. calibrated) x 10 disabled at 50 ns/div.	
HOLDOFF:	Variable from 1 to 10 divisions	
XY Mode:	Phase shift < 3° at 120 kHz.	
	Pass band	CH1 along X
	DC coupling	0 Hz to 2 MHz
	AC coupling	10 Hz to 2 MHz
		CH2 along Y
		0 Hz to 40 MHz
		10 Hz to 40 MHz

6.3. Trigger System

Source:	Sensitivity in normal mode:	
	(0.5 div.	0 to 10 MHz
	CH1 + CH2 (1 div.	10 MHz to 50 MHz
	(1.5 div.	50 MHz to 75 MHz
	ALT: source according to display mode:	
	CH1 trigger	CH1
	ALT trigger	CH1 puis CH2
	CHOP trigger	CH1
	ADD trigger	CH1
	CH2 trigger	CH2
	- CH2 trigger	CH2
	LINE: mains triggering	
	EXT: 60 mV p-p	0 to 10 MHz
	150 mV(rms)	10 MHz to 50 MHz
	500 mV(rms)	50 MHz to 75 MHz
	(Protection: ± 420 V (DC + AC peak, f < 1 kHz)	
	Input impedance 1 MΩ // 25 pF)	
Filters:	Pass band:	
	AC	10 Hz to 75 MHz
	DC	0 Hz to 75 MHz
	LFR (rejection)	10 kHz to 75 MHz
	HFR (rejection)	0 Hz to 10 kHz
	TVH: synchronise video signal on line time signals	
	TVV: synchronise video signal on frame time signals	
Horizontal mode:	AUTO (relaxed mode) Normal (triggered mode)	
Slope:	Falling edge Rising edge	
Level:	Adjustment range: - P-P: between minimum and maximum points of signal, 80 % of peak-peak signal amplitude - Normal: ± 12 divisions	

6. Technical Specifications

Only values with an assigned tolerance or limit are guaranteed. Values listed without a tolerance are provided as indications, and are not guaranteed.

6.1. Vertical Deflection (CH1 and CH2)

Pass band at -3 dB:	> 40 MHz from 10 mV/div. to 20 V/div. > 35 MHz from 1 mV/div. to 5 mV/div.
Rise time:	< 9 ns
Vertical deflection coefficients (sensitivity):	Ranges: 1 mV/div. to 20 V/div. $\pm 3\%$ (14 positions, sequences 1, 2, and 5).
Variable vertical deflection coefficients:	Multiply V/div. rating by 1 to 2.5 (reduce amplitude of displayed signal) Uncalibrated position: coupling indicator light flashes Calibrated position (left stop): coupling indicator light on
Maximum input voltage:	Continuous: ± 420 V (DC + AC peak at 1 kHz)
F (frequency) level limitation:	0 to 1.8 MHz 420 V peak from 1.8 to 40 MHz -20 dB/decade
Thickness of focused trace:	< 2 mm
CHOP frequency:	200 kHz approx.
Input coupling:	DC : 0 to 40 MHz AC : 10 Hz to 40 MHz GND : 0-V reference
Input impedance:	1 M Ω $\pm 1\%$ // 25 pF
Square wave respons :	Overshoot < 3 % Aberration at 10 mV/div.: - On plateau < 1 mm (1 kHz to 1 MHz) - Before edge < 2 mm (1 MHz (Tm < 100 ps))
Crosstalk:	1 mV/div. to 5 mV/div. 30 dB typ. 10 mV/div. to 5 V/div. 40 dB typ. 10 V/div. to 20 V/div. 30 dB typ. (Reference at 35 MHz, same sensitivity on CH1 and CH2, signal amplitude 6 div.)
Display:	CH1 : CH1 only ALT : CH1 then CH2 in alternation CHOP : CH1 and CH2 chopped ADD : CH1 + CH2 or CH1 - CH2 CH2 : CH2 only XY : CH1 along X and CH2 along Y TEST : I = f(V) (voltage along X, current along Y)

4. Functional Description

4.1. Vertical Channels

POSITION Vertical positioning of traces, then XY horizontal framing for POSITION **8**

POSITION Horizontal positioning of traces.

VOLT/DIV. Vertical sensitivity: 14 positions (1 mV to 20 V/div.) plus GND coupling.

VAR Continuous adjustment of vertical sensitivity. When the button is locked in left stop position, the corresponding channel is calibrated. Vertical decalibration is indicated by the active coupling light flashing.

AC - DC - GND Input coupling
Select by pressing the \rightarrow keys.
• Brief press, input coupling selection

AC Display AC component (DC component suppressed),

DC Display complete signal (0 to 40 MHz).

GND Display channel zero-volt reference (without short-circuiting the input signal). Helps to position the trace accurately on the screen, using POSITION **8** and **12**.

CH1 et CH2 Signal inputs to be observed on BNC connectors.

GB

If VOLT/DIV. controls **22** and **14** are set to GND, pushbuttons **20** and **16** are disabled.

• Hold down to display the CH1 or CH2 channel reference, coupling unchanged.

4. Functional Description (continued)

4.2. Display Modes



CH1 - CH2 - ALT - CHOP - ADD - TEST
Select by pressing the ← or → keys:

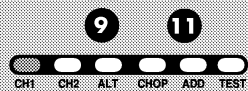

CH1 Display channel CH1 only.



CH2 Display channel CH2 only.

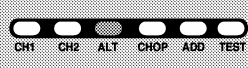

ALT Display CH1 and CH2 in alternate mode.

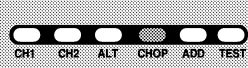

CHOP Display CH1 and CH2 in chopped mode. During a single sweep, the channel goes from CH1 to CH2 at the chopping speed (200 kHz).



ADD Display channels CH1 + CH2. The difference between channels, CH1 - CH2, is displayed if -CH2 mode is active.



TEST Component test function; display the $I = f(V)$ curve in orthogonal coordinates (V plotted along X, I along Y).



- CH2 Invert channel CH2.

4.3. Timebase

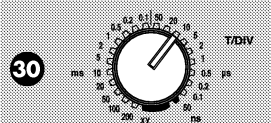

T/DIV. Sweep coefficient: 21 positions
50 ns to 200 ms/div.

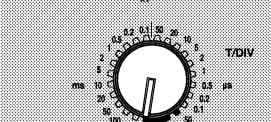

X-Y : When the button is in X-Y position, channels CH1 and CH2 are displayed in orthogonal coordinates (CH1 along the X axis, CH2 along Y). The timebase is inoperative. Vertical positioning is performed using the POSITION 12 control, and horizontal positioning is performed using the POSITION 8 control.

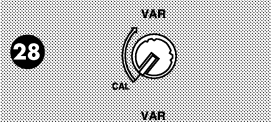

VAR Continuous adjustment of sweep coefficient. When the button is locked in the left stop position, the timebase is calibrated. Decalibration is shown by the source indicator light flashing.

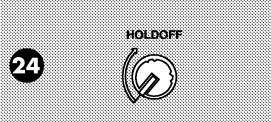
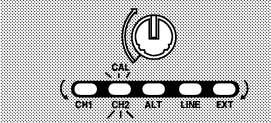

HOLDOFF Continuous adjustment of minimum time between two consecutive sweeps. This control can be used to inhibit untimely triggering events (multiple triggering conditions within a period of the observed signal). In normal use, lock the button in its left stop position (see § 5.4: Video Signal Display).

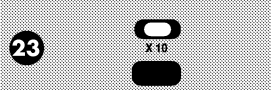

x10 Horizontal expansion (x10) to expand certain details and reach 10 ns/div. (control inoperative at 50 ns/div.).

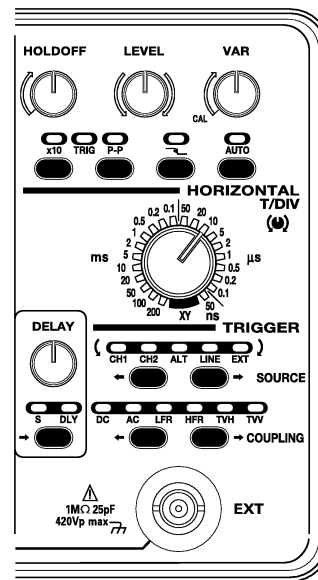

5. Applications (continued)

5.5. Component Tester Application



5.5.1. Diode Characteristic Display

► Select TEST display mode.

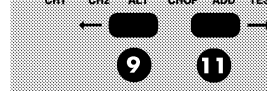

► Connect the diode to the COMPONENT TESTER sockets.

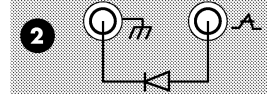

An internal power supply supplies an off-load voltage of 18 V peak-peak at a frequency of 75 Hz (maximum current: 9 mA).

The curve corresponds to the diode characteristic ($I = f(V)$).

On the left of the screen: inverse characteristic
 $R_d = \text{infinite}$
 $I = 0$

On the right of the screen: direct characteristic
 $R_d = 0$
 $V = 0$

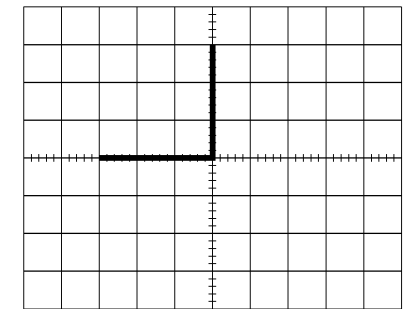

5.5.2. Diode with Direct Resistance

► Insert a 1.2 kΩ resistor, R, in series with the diode. The direct characteristic then has slope $V/I = R$.

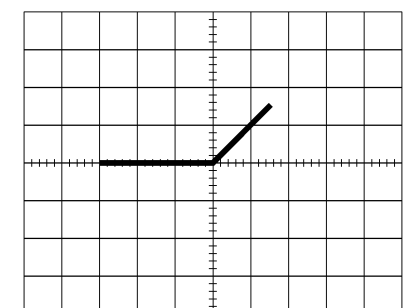

5.6. Timebase Generator Output

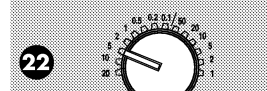

(usable to 1 μs/div. approx.).

► Deselect TEST display mode.

► Select AUTO mode.

► Select source EXT

► Connect the CH1 5 V/div. input to Socket 3.

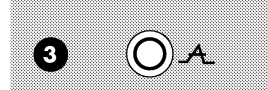

A ramp is displayed on the screen.

Application: wobulating of a generator with VCF input.

5. Applications (continued)

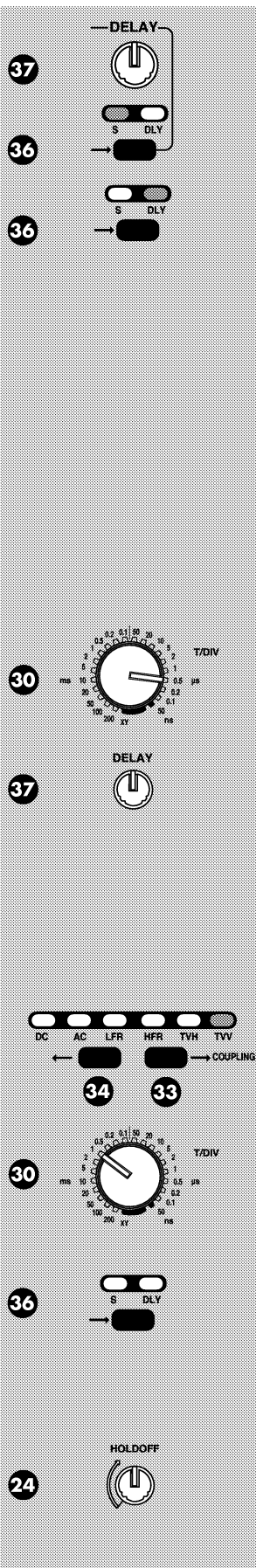

5.4.2. Detailed Examination of Burst

► Select SEARCH Mode, and adjust the DELAY control to bring the beginning of the highlighted region onto the rising edge of the line synchronisation pulse (Figure 3).

► Select DELAY Mode. The burst goes to the beginning of the screen (Figure 4).

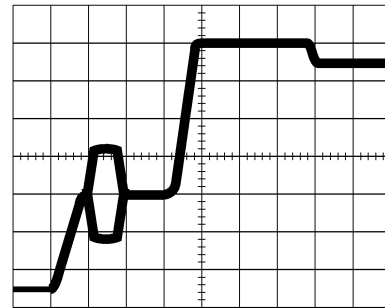

figure 3

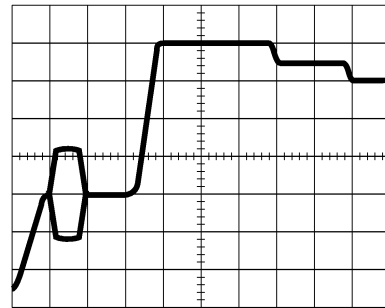

figure 4

► Lower the sweep coefficient again, to 0.5 $\mu\text{s}/\text{div}$. The burst now appears on the full screen, and may be examined in detail (Figure 5). Note that the sweep start position remains unchanged with respect to the signal. It can be further fine-tuned by adjusting the DELAY control.

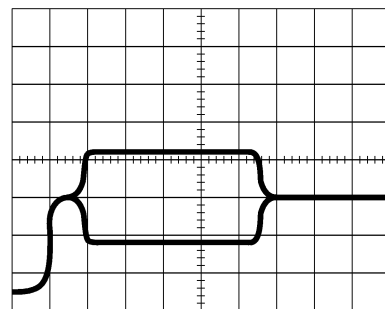

figure 5

5.4.3. Examination of a TV Frame

► Select:
• Coupling: TVV

• Sweep coefficient: 1 ms/div.

► Cancel the trigger delay (S and DLY off). Keep the other settings as before. The image displayed corresponds to the first ten milliseconds of the TV frame. The synchronisation sequence is perfectly visible at the beginning of the screen. Note the blurring of the video content. The image is made up of the superposition of the even and odd frames of the composite signal.

► Adjust the HOLDOFF control until a sharp image is obtained. The trace now corresponds to a single frame. The synchronisation pulse of the second frame is inhibited by the HOLDOFF function

4. Functional Description (continued)

4.4. Triggering

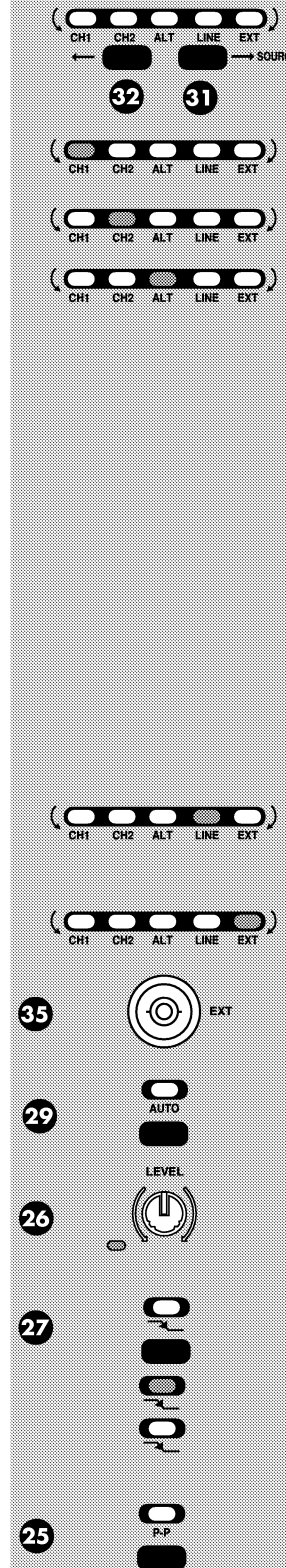

SOURCE Trigger source
Select by pressing the ← or → buttons:

- CH1** Synchronisation on CH1.
- CH2** Synchronisation on CH2.
- ALT** Trigger source defined according to display mode:

Display mode	Trigger channel
	CH1
	CH2
	Channel 1 synchronised with CH1 Channel 2 synchronised with CH2
	CH1
	CH1
	CH2

- LINE** Synchronisation on the mains frequency.
The coupling control is disabled.
- EXT** Synchronisation on external source.
- EXT** External synchronisation signal input via BNC connector (see specification, Chapter 6).
- AUTO** Automatic triggering of timebase.
Traces visible even when no triggering event occurs.
- LEVEL** Adjust trigger level.
The TRIG indicator light is lit when a trigger event is detected (timebase activated).
- Trigger slope
Indicator light on: trigger on falling slope
Indicator light off: trigger on rising slope
- P-P** Peak-to-peak trigger.
The trigger reference level (fine adjustment using LEVEL) is automatically located between the lower peak and upper peak of the selected signal, guaranteeing triggering regardless of the amplitude or DC component of the source signal (80% of the signal amplitude for $f > 100$ Hz).

4. Functional Description (continued)

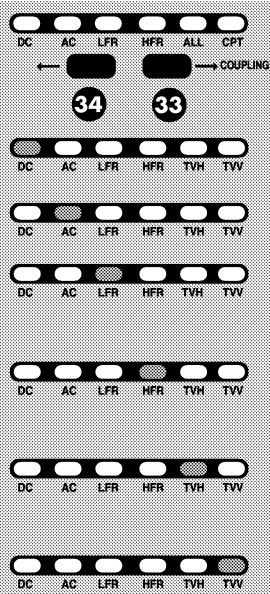

COUPLING Coupling of trigger source
Select by pressing the ← or → key:

- DC** DC coupling (0 to 40 MHz)
- AC** AC coupling (10 Hz to 40 MHz)
- LFR** Reject source signal frequencies below 10 kHz (helps when looking at signals with an undesirable low-frequency signal, such as 50 Hz, etc.)
- HFR** Reject source signal frequencies above 10 kHz (helps when looking at low-frequency signals with high-frequency noise)
- TVH** Trigger on line synchronisation pulses from a video signal (recommended sweep coefficient for examining a TV line: 0.5 to 20 $\mu\text{s}/\text{div}$.)
- TVV** Trigger on frame synchronisation pulses from a video signal (recommended sweep coefficient for examining a TV frame: 50 $\mu\text{s}/\text{div}$. to 200 $\mu\text{s}/\text{div}$.)

Looking at a TV signal with TVH and TVV



- off: positive video modulation TV signal
- on: negative video modulation TV signal

4.5. Delay

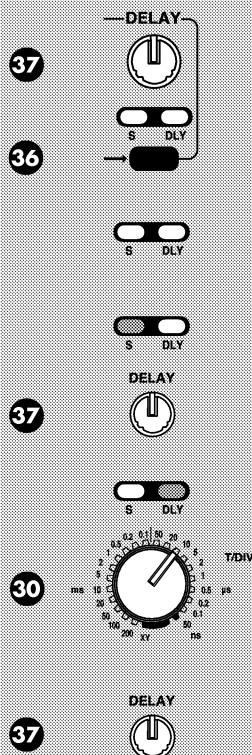

This mode is used for a detailed examination (at high sweep speed) of a portion of a signal after the selected triggering event. The trigger delay system has 18 ranges that are switched automatically according to the sweep coefficient. The DELAY **37** control is used for continuous adjustment of the delay (at least 10 div.).

- DELAY** Select by pressing key **36** :
- **Normal mode** (S and DLY off) : the sweep starts immediately (triggering event at the far left of the trace).
 - **SEARCH mode** (S on) : triggering is identical to Normal Mode, but the right-hand part of the trace is brighter.
 - Using the DELAY button, position the limit between the two sections slightly to the left of the detail to be examined.
 - **DELAY mode** (DLY on) : timebase triggering occurs at the instant determined in Search Mode (the detail to be examined is at the left of the screen).
 - Adjust T/DIV. again to expand the detail to be examined.
 - If necessary, centre the detail more accurately using the DELAY button. The DELAY button can be used to position the part of the trace to be examined at a particular point on the screen (see § 5.4, Video Signal Display).

5. Applications (continued)

5.4. Video Signal Display

The purpose of this example is to illustrate the TV synchronisation (H and V), delay, and HOLDOFF functions.

5.4.1. Examining a TV Line

➤ Select:

- Display mode: CH1

- Trigger source: CH1

- TVH coupling.

- Trigger slope: positive (indicator light off).

- Sweep coefficient 10 $\mu\text{s}/\text{div}$.

➤ Inject a composite video TV signal with the following characteristics onto channel CH1:

- Positive modulation,
- Grey-scale vertical bands.

➤ Select the vertical sensitivity appropriate to signal amplitude so that the image covers approximately 80% of screen height. If necessary, adjust the framing control.

The image observed corresponds to a complete TV line (64 μs). The synchronisation pulse, chrominance burst, and video contents are clearly visible (Figure 1).

➤ Lower the sweep coefficient to 2 $\mu\text{s}/\text{div}$. The beginning of the line is dilated, and the trigger point remains unchanged (line synchronisation pulse) (Figure 2).

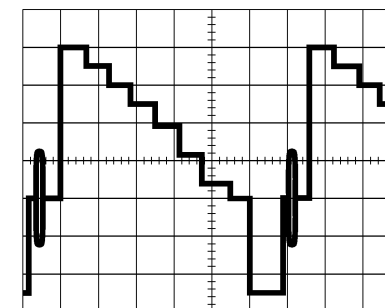
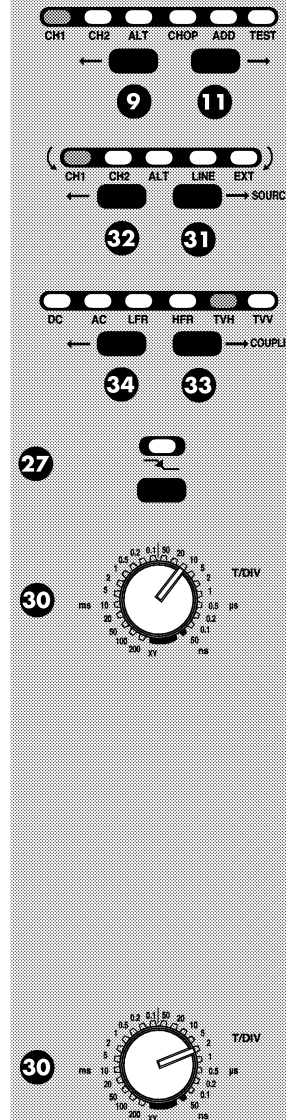

figure 1

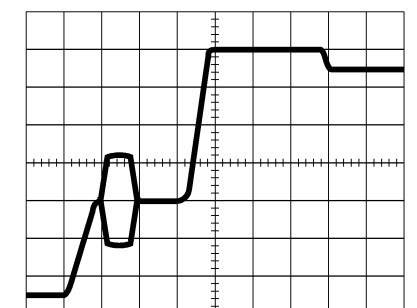

figure 2

5. Applications (continued)

5.3. Phase Difference Measurement

5.3.1. In Dual-Curve Mode

To measure the phase shift between two different signals of the same frequency:

► Select the following functions:

- Display mode: ALT (or CHOP for low frequencies)

- Trigger mode: AUTO

- Coupling: identical on the two channels.

► Connect the two signals to CH1 and CH2

► Adjust:

- Vertical sensitivities

- Sweep coefficient

- LEVEL control

- Positions of CH1 and CH2 so that the signals are symmetric about axis O-O'.

A : Number of horizontal divisions between the two curves.

B: Number of horizontal divisions in one period.

Calculate phase difference (φ) in degrees:

$$\varphi = (A / B) \times 360^\circ$$

For example, for this figure:

A = 0.5 div., B = 4 div., therefore $\varphi = 45^\circ$

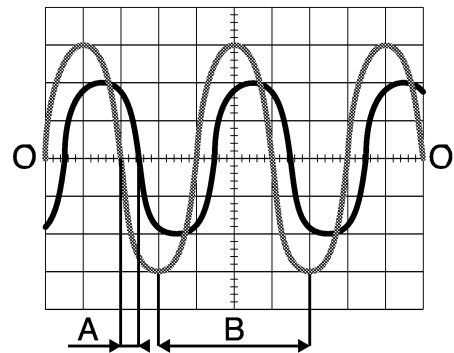

5.3.2. In XY Mode

► Keep the settings from the paragraph above, and select display mode XY.

Calculate phase difference (φ) in degrees:

$$\sin \varphi = AB / CD \text{ therefore } \varphi = \arcsin AB / CD$$

For example, for this figure:

AB = 3.5 div., CD = 5 div.

therefore $\sin \varphi = 0,7$ hence $\varphi = 45^\circ$

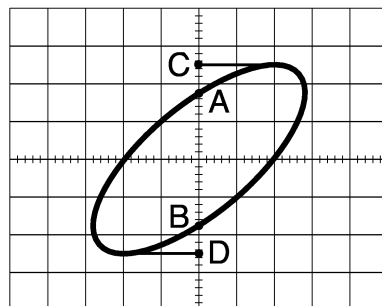

4. Functional Description (continued)

4.6. Other Functions

COMPONENT TESTER Input sockets (for 4 mm banana plug) used to test components (see § 5.5: Application of component tester).

Socket **3** is the test socket (component connection hot point). This socket is also used as the timebase output.

Socket **2** is the earth socket (component connection cold point).



Components to be tested must not be powered by an external source.



TEST display mode must be selected for this function.

PROBE ADJUST

Rectangular signal output (2.5 V peak-peak, 1 kHz).

This signal is used to compensate the measuring probes, or to control the vertical amplifiers and the timebase (see § 5.1: Calibration Signal Display).

TRACE ROTATION

Adjust trace parallelism with respect to the horizontal axes. A screwdriver is required to perform this adjustment.

MODULATION Z

A TTL signal containing a command to extinguish the spot is input via BNC Connector **0** on the back panel.

(Level 0 → trace off; Level 1 → trace on).

This input also allows a time reference signal (marker) to be used.

Gradual light modulation capability

1.3 V < level < 2.6 V

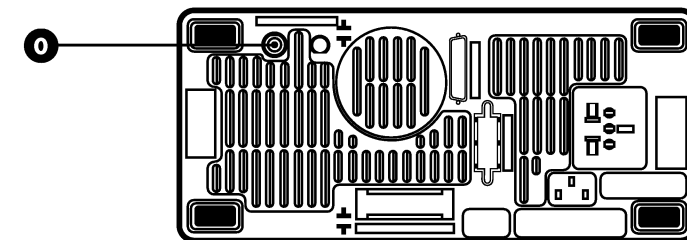

Rear panel of device

XY

Display channels CH1 along X and CH2 along Y in orthogonal coordinates.

Perform horizontal framing using the POSITION **8** control.

SWEEP GENERATOR

Component tester output signal

Amplitude : ± 9 V

Usable to 1 μ s/div. approx.

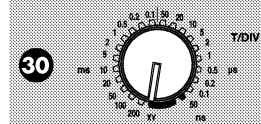
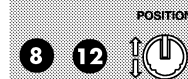
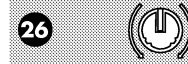
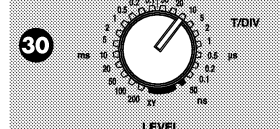
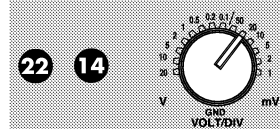
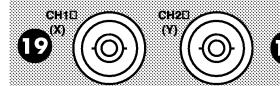
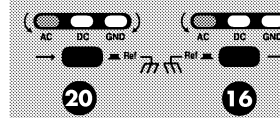
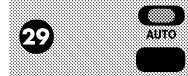
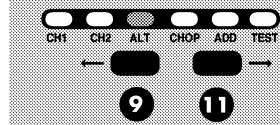

5. Applications

5.1. Probe Adjustment using the Calibration Signal

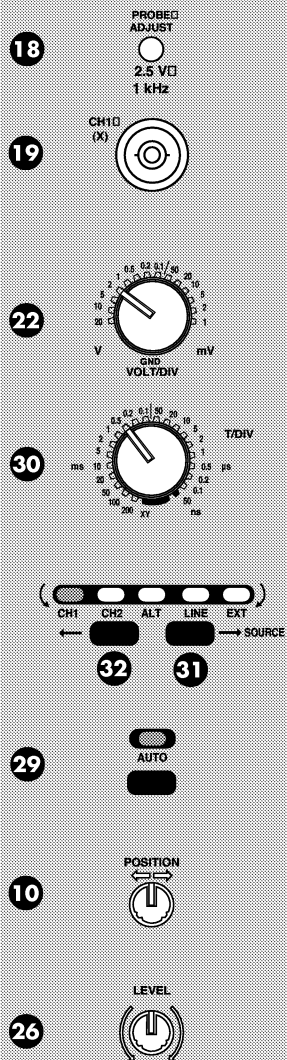

► Connect the PROBE ADJUST

output to the CH1 input using a 1/1 or 1/10 ratio measurement probe.

► Select the following functions:

- CH1 vertical sensitivity: 0.5 V/div. (1/1 probe)
50 mV/div. (1/10 probe).

- Sweep coefficient: 0.2 ms/div.

- Trigger source: CH1

- Trigger mode: AUTO

► If necessary, carry out horizontal framing using the POSITION **10** control,

and stabilise the trace using the LEVEL potentiometer.

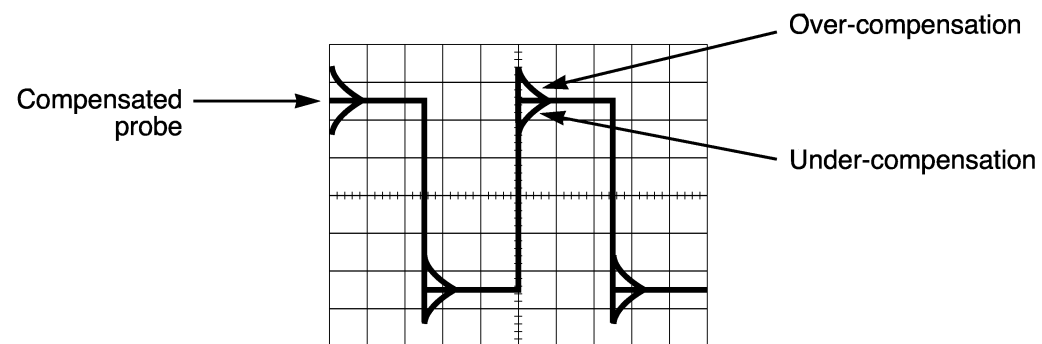

The calibration signal can also be displayed on channel CH2.

5. Applications (continued)

5.2. Amplitude and Frequency Measurements

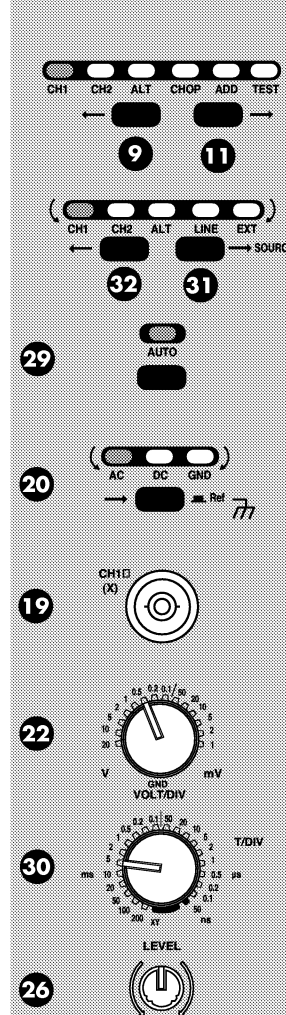

► Select the following functions:

- Display mode: CH1

- Trigger source: CH1

- Trigger mode: AUTO

- Input coupling: AC

► Connect a signal to one of the input terminals, CH1 or CH2: CH1

► Adjust:

- Vertical sensitivity: A

- Sweep coefficient: B

► If the signal scrolls on the screen, adjust the trigger level using the LEVEL potentiometer until a stable image is obtained.

C: Number of vertical divisions of peak-peak signal.
D: Number of horizontal divisions in one period.

Amplitude calculation: $V_{p-p} = C \times A$

Period calculation: $T = D \times B$

Frequency calculation: $F = 1/T$

For example, for this figure, $A = 0.5 \text{ V/div.}$, $B = 5 \text{ ms/div.}$, $C = 4 \text{ div.}$, $D = 4 \text{ div.}$

Hence $V_{p-p} = 2 \text{ V}$, $T = 20 \text{ ms}$, $F = 50 \text{ Hz}$.

