

1652C/1653B/1654B

Electrical Installation Tester

Users Manual

September 2010

© 2010 Fluke Corporation. All rights reserved.

Specifications are subject to change without notice.

All product names are trademarks of their respective companies.

LIMITED WARRANTY AND LIMITATION OF LIABILITY

Each Fluke product is warranted to be free from defects in material and workmanship under normal use and service. The warranty period is three years and begins on the date of shipment. Parts, product repairs, and services are warranted for 90 days. This warranty extends only to the original buyer or end-user customer of a Fluke authorized reseller, and does not apply to fuses, disposable batteries, or to any product which, in Fluke's opinion, has been misused, altered, neglected, contaminated, or damaged by accident or abnormal conditions of operation or handling. Fluke warrants that software will operate substantially in accordance with its functional specifications for 90 days and that it has been properly recorded on non-defective media. Fluke does not warrant that software will be error free or operate without interruption.

Fluke authorized resellers shall extend this warranty on new and unused products to end-user customers only but have no authority to extend a greater or different warranty on behalf of Fluke. Warranty support is available only if product is purchased through a Fluke authorized sales outlet or Buyer has paid the applicable international price. Fluke reserves the right to invoice Buyer for importation costs of repair/replacement parts when product purchased in one country is submitted for repair in another country.

Fluke's warranty obligation is limited, at Fluke's option, to refund of the purchase price, free of charge repair, or replacement of a defective product which is returned to a Fluke authorized service center within the warranty period.

To obtain warranty service, contact your nearest Fluke authorized service center to obtain return authorization information, then send the product to that service center, with a description of the difficulty, postage and insurance prepaid (FOB Destination). Fluke assumes no risk for damage in transit. Following warranty repair, the product will be returned to Buyer, transportation prepaid (FOB Destination). If Fluke determines that failure was caused by neglect, misuse, contamination, alteration, accident, or abnormal condition of operation or handling, including overvoltage failures caused by use outside the product's specified rating, or normal wear and tear of mechanical components, Fluke will provide an estimate of repair costs and obtain authorization before commencing the work. Following repair, the product will be returned to the Buyer transportation prepaid and the Buyer will be billed for the repair and return transportation charges (FOB Shipping Point).

THIS WARRANTY IS BUYER'S SOLE AND EXCLUSIVE REMEDY AND IS IN LIEU OF ALL OTHER WARRANTIES, EXPRESS OR IMPLIED, INCLUDING BUT NOT LIMITED TO ANY IMPLIED WARRANTY OF MERCHANTABILITY OR FITNESS FOR A PARTICULAR PURPOSE. FLUKE SHALL NOT BE LIABLE FOR ANY SPECIAL, INDIRECT, INCIDENTAL OR CONSEQUENTIAL DAMAGES OR LOSSES, INCLUDING LOSS OF DATA, ARISING FROM ANY CAUSE OR THEORY.

Since some countries or states do not allow limitation of the term of an implied warranty, or exclusion or limitation of incidental or consequential damages, the limitations and exclusions of this warranty may not apply to every buyer. If any provision of this Warranty is held invalid or unenforceable by a court or other decision-maker of competent jurisdiction, such holding will not affect the validity or enforceability of any other provision.

Fluke Corporation
P.O. Box 9090
Everett, WA 98206-9090
U.S.A.

Fluke Europe B.V.
P.O. Box 1186
5602 BD Eindhoven
The Netherlands

Table of Contents

Title	Page
Introduction	1
How to Contact Fluke	1
Safety	2
Unpacking the Tester	4
Operating the Tester	6
Using the Rotary Switch	6
Understanding the Pushbuttons	7
Understanding the Display	9
Input Terminals	15
Using the IR Port	15
Error Codes	16
Power-On Options	17
Making Measurements	19
Measuring Volts and Frequency	19
Measuring Insulation Resistance	20
Measuring Continuity	21
Measuring Loop/Line Impedance	22
Loop Impedance (Line to Protective Earth L-PE)	22
Earth Resistance Testing by Loop Method	25
Line Impedance	26
Measuring RCD Tripping Time	28
Measuring RCD Tripping Current	32
RCD Testing in IT Systems	34
Measuring Earth Resistance	34
Testing Phase Sequence	36
Memory Mode	37
Storing a Measurement	38
Recalling a Measurement	38
Clearing Memory	39
Uploading Test Results	40
Maintaining the Tester	41
Cleaning	41
Testing and Replacing the Batteries	41
Testing the Fuse	43
Specifications	44
Features by Model	44

General Specifications	45
Category Ratings and Usage	46
Electrical Measurement Specifications	46
Insulation Resistance (R_{ISO}).....	46
Insulation Resistance (R_{ISO}) (cont.)	47
Continuity (R_{LO}).....	47
Loop Tests (Z_l).....	48
RCD/FI Tests ($I_{\Delta T}$, $I_{\Delta N}$).....	49
Earth Tests (R_E).....	50
AC Voltage Measurement (V).....	50
Continuity Testing (R_{LO})	50
Insulation Resistance Measurement (R_{ISO}).....	51
Loop and Line Impedance (Z_l).....	52
No Trip and Hi Current Modes RCD/FI.....	52
Prospective Earth Fault Current Test (PSC/ I_k).....	52
RCD Testing.....	53
RCD Types Tested	53
Test Signals.....	53
Tripping Speed Test (ΔT).....	54
Maximum Trip Time.....	54
RCD/FI-Tripping Current Measurement/Ramp Test ($I_{\Delta N}$) .	55
Earth Resistance Test (R_E).....	55
Phase Sequence Indication.....	56
Mains Wiring Test.....	56
Operating Ranges and Uncertainties per EN 61557	57
Operating Uncertainties per EN 61557.....	58

List of Tables

Table	Title	Page
1.	Symbols	3
2.	Standard Accessories	4
3.	Country Specific Mains Cords	5
4.	Rotary Switch	6
5.	Pushbuttons	7
6.	Display Features	10
7.	Error Codes	16
8.	Power-On Options.....	17

List of Figures

Figure	Title	Page
1.	Rotary Switch	6
2.	Pushbuttons	7
3.	Models 1652C and 1653B Display Features	9
4.	Model 1654B Display Features	10
5.	Input Terminals.....	15
6.	Error Display	16
7.	Lead Swapping Modes.....	18
8.	Volts Display/Switch and Terminal Settings	19
9.	Insulation Resistance Display/Switch and Terminal Settings	20
10.	Continuity and Continuity Zero Display/Switch and Terminal Settings	21
11.	Loop/Line Impedance/Switch and Terminal Settings.....	22
12.	Display After Zeroing.....	24
13.	3-Wire Connection for Earth Resistance Loop Test	25
14.	Line Impedance Display	26
15.	Measuring in a 3-Phase System.....	27
16.	RCD Tripping Time Display/Switch and Terminal Settings.....	28
17.	RCD Tripping Current/Switch and Terminal Settings	32
18.	Connection for RCD Testing on IT Electrical Systems	34
19.	Earth Resistance Display/Switch and Terminal Settings	34
20.	Earth Resistance Test Connection	35
21.	Phase Sequence Display/Switch and Terminal Settings.....	36
22.	Phase Sequence Test Connection	36
23.	Attaching the IR Adapter	40
24.	Replacing the Batteries	42

Electrical Installation Tester

Introduction

The Fluke Model 1652C, Model 1653B, and Model 1654B are battery powered electrical installation testers. This manual applies to all models. All figures show the Model 1653B.

These testers are designed to measure and test the following:

- Voltage and Frequency
- Insulation Resistance (EN61557-2)
- Continuity (EN61557-4)
- Loop/Line Resistance (EN61557-3)
- Residual Current Devices (RCD) Tripping Time (EN61557-6)
- RCD Tripping Current (EN61557-6)
- Earth Resistance (EN61557-5)
- Phase Sequence (EN61557-7)

How to Contact Fluke

To contact Fluke, call one of the following telephone numbers:

- Technical Support USA: 1-800-44-FLUKE (1-800-443-5853)
- Calibration/Repair USA: 1-888-99-FLUKE (1-888-993-5853)
- United Kingdom: +44 1603 256600
- Germany, Austria, Switzerland: +49 (0)69 / 2 22 22-0210
- Canada: 1-800-36-FLUKE (1-800-363-5853)
- Europe: +31 402-675-200
- Japan: +81-3-3434-0181
- Singapore: +65-738-5655
- Anywhere in the world: +1-425-446-5500

Or, visit Fluke's website at www.fluke.com.

To register your product, visit <http://register.fluke.com>.

To view, print, or download the latest manual supplement, visit <http://us.fluke.com/usen/support/manuals>.

Safety

See Table 1 for a list of symbols used on the product and in this manual.

A **Warning** identifies hazardous conditions and actions that could cause bodily harm or death.

A **Caution** identifies conditions and actions that could damage the Imager or cause permanent loss of data.







⚠ ⚠ Warnings: Read Before Using

To prevent possible electrical shock, fire, or personal injury:

- Use the product only as specified, or the protection supplied by the product can be compromised.
- Do not use the product around explosive gas, vapor or in damp or wet environments.
- Do not use test leads if they are damaged. Examine the test leads for damaged insulation, exposed metal, or if the wear indicator shows. Check test lead continuity.
- Use only current probes, test leads, and adapters supplied with the product.
- Measure a known voltage first to make sure that the product operates correctly.
- Do not use the product if it is damaged.
- Have an approved technician repair the product.
- Do not apply more than the rated voltage between the terminals or between each terminal and earth ground.
- Remove test leads from the tester before the tester case is opened.
- Do not operate the product with covers removed or the case open. Hazardous voltage exposure is possible.
- Use caution when working with voltages above 30 V ac rms, 42 V ac peak, or 60 V dc.
- Use only specified replacement fuses.
- Use the correct terminals, function, and range for measurements.
- Keep fingers behind the finger guards on the probes.

- **Connect the common test lead before the live test lead and remove the live test lead before the common test lead.**
- **Replace the batteries when the low battery indicator shows to prevent incorrect measurements.**
- **Use only specified replacement parts.**
- **Do not use the tester in distribution systems with voltages higher than 550 V.**
- **Comply with local and national safety codes. Use personal protective equipment (approved rubber gloves, face protection, and flame-resistant clothes) to prevent shock and arc blast injury where hazardous live conductors are exposed.**

Table 1. Symbols

Symbol	Description	Symbol	Description
	Fuse.		Caution! Risk of Electric Shock.
	Conforms to requirements of European Union and European Free Trade Association.		Important information. See manual.
	Double Insulated (Class II) Equipment		Earth Ground
	Do not use in distribution systems with voltages higher than 550 V.		
CAT III / CAT IV	CAT III Testers are designed to protect against transients in fixed-equipment installations at the distribution level; CAT IV Testers are designed to protect against transients from the primary supply level (overhead or underground utility service).		

Unpacking the Tester

The tester comes with the items listed in Table 2. If the tester is damaged or an item is missing, contact the place of purchase immediately.

Table 2. Standard Accessories

Description	1652C EU	1653B/1654B EU	1652C UK	1653B/1654B UK	Part Number
165X-8008 Probe, Multifunctional	√	√	√	√	2000757
Country Specific Mains Test Cord	√	√	√	√	See Table 3
TL-L1, Test Lead, Red	√	√			2044945
TL-L2, Test Lead Green	√	√			2044950
TL-L3, Test Lead Blue	√	√			2044961
Probe, Test, Banana Jack, 4 mm Tip, Red	√	√			2099044
Probe, Test, Banana Jack, 4 mm Tip, Green	√	√			2065297
Probe, Test, Banana Jack, 4 mm Tip, Blue	√	√			2068904
102-406-003, Probe cap,GS-38 Red	√	√			1942029
102-406-002, Probe cap,GS-38 Green	√	√			2065304
102-406-004, Probe cap,GS-38 Blue	√	√			2068919
AC285-5001,175-276-013 AC285 Large alligator clip, Red	√	√			2041727
AC285-5001-02,175-276-012 AC285 Large alligator clip, Green	√	√			2068133
AC285-5001-03,175-276-0114 AC285 Large alligator clip, Blue	√	√			2068265

Table 2. Standard Accessories (cont.)

Description	1652C EU	1653B/1654B EU	1652C UK	1653B/1654B UK	Part Number
Test lead set, 600 V, Fused Probe with alligator clips and prods, set of spare GS38 tips - Red, Blue, Green [Replacement fuse set (3-piece): Fuse F 10 A 600 V, 50 kA, 6.3 x 32 mm for TL165X/UK (PN 3588741)]			√	√	2491989
CD ROM, Users Manual	√	√	√	√	3209538
Quick Reference Guide	√	√	√	√	3278157
Case, Tool Box, Yellow	√	√	√	√	1664213
Hard Case Insert, Foam, Polyurethane	√	√	√	√	2061011
Carrying Strap, Padded	√	√	√	√	2045406
Fluke-1653-2014, IR Adapter		√		√	2043365
Fluke Zero Adapter	√	√	√	√	3301338

Table 3. Country Specific Mains Cords

Mains Cord	Cord Type	Part Number
British	BS1363	2061367
Schuko	CEE 7/7	2061332
Denmark	AFSNIT 107-2-DI	2061371
Australia/New Zealand	AS 3112	2061380
Switzerland	SEV 1011	2061359
Italy	CEI 23-16/VII	2061344

Operating the Tester Using the Rotary Switch

Use the rotary switch (Figure 1 and Table 4) to select the type of test you want to perform.

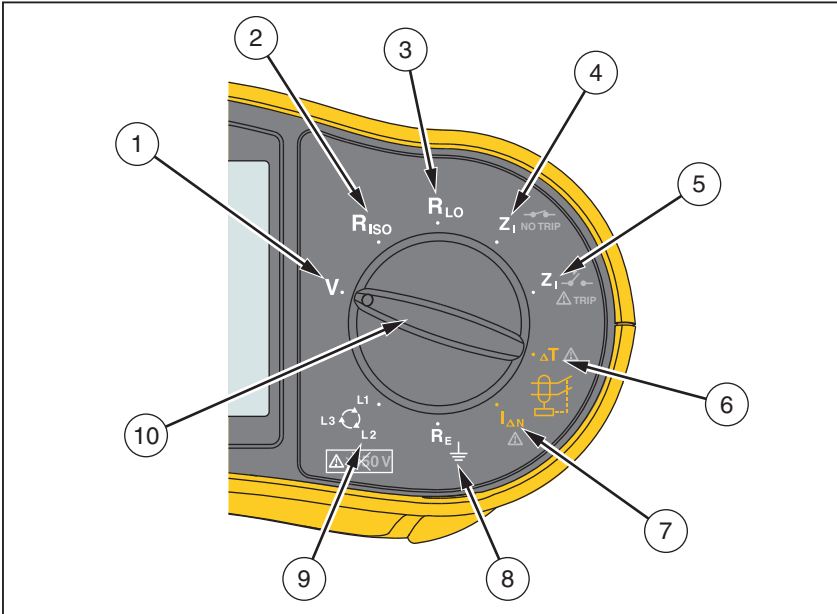

apx013f.eps

Figure 1. Rotary Switch
Table 4. Rotary Switch

Number	Symbol	Measurement Function
①	V	Volts.
②	R_{ISO}	Insulation resistance.
③	R_{LO}	Continuity.
④	Z_I NO TRIP	Loop impedance — No trip mode.
⑤	Z_I TRIP	Loop impedance — Hi current trip mode.
⑥	$\Delta T \Delta$	RCD tripping time.
⑦	$I_{\Delta N} \Delta$	RCD tripping level.
⑧	R_E	Earth resistance.
⑨	Phase rotation symbol	Phase rotation.
⑩	N/A	Rotary switch.

Understanding the Pushbuttons

Use the pushbuttons (Figure 2 and Table 5) to control operation of the tester, select test results for viewing, and scroll through selected test results.

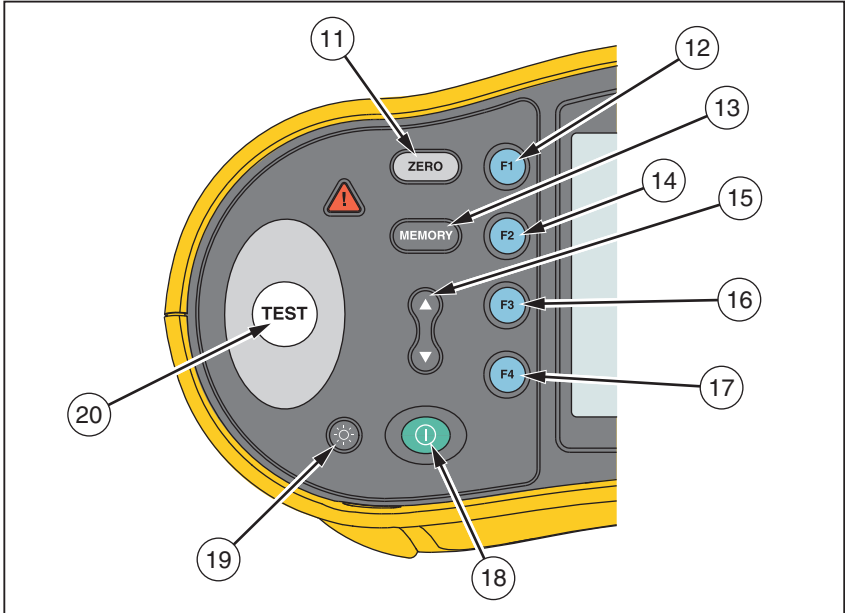







apx012f.eps

Figure 2. Pushbuttons

Table 5. Pushbuttons

No.	Button	Description
⑪	ZERO	Zero test lead resistance offset.
⑫	F1	<ul style="list-style-type: none"> • Loop input select (L-N, L-PE). • Voltage input select (L-N, L-PE, N-PE). • Insulation test: L (P), L-N (P/N), L-PE (P/E), or N-PE (N/E) in extended documentation mode. • RCD current rating (10, 30, 100, 300, 500, 1000 mA or VAR). • Memory SELECT.
⑬	MEMORY	<ul style="list-style-type: none"> • Enters Memory mode. • Activates memory soft key selections (F1, F2, F3, or F4).

Table 5. Pushbuttons (cont.)

No.	Button	Description
⑭	F2	<ul style="list-style-type: none"> • RCD Current multiplier (x1/2, x1, x5, AUTO). • Memory STORE. • Select Loop impedance test accuracy (Ω, $m\Omega$) – hi current trip mode only • Continuity test: $R_x/2$ (R_1+R_2), $R/2$ (R_2), $x1$ (r_1), $/2$ (r_2) or $x5$ (r_n) in extended documentation mode.
⑮		<ul style="list-style-type: none"> • Scroll memory locations. • Set memory location codes. • Scroll Auto test results. • Adjust current for VAR function. • Display results if noise is present.
⑯	F3	<ul style="list-style-type: none"> • Select RCD: Type AC (sinusoidal), Type AC Selective, Type A (half-wave), Type A Selective, Type B (smooth DC), or Type B Selective. • Memory RECALL. • Battery test. • Loop R_E / I_K
⑰	F4	<ul style="list-style-type: none"> • RCD test polarity (0, 180 degrees). • Insulation test voltage (50, 100, 250, 500, or 1000 V). • Memory CLEAR.
⑱		Turns the tester on and off. The tester will also shut off automatically is there is no activity for 10 minutes.
⑲		Turns the backlight on and off.
⑳		<p>Starts the selected test.</p> <p>The  key is surrounded by a “touch pad”. The touch pad measures the potential between the operator and the tester’s PE terminal. If you exceed a 100 V threshold, the  symbol above the touch pad is illuminated.</p>

Understanding the Display

Figures 3 and 4 and Table 6 describe the display features.

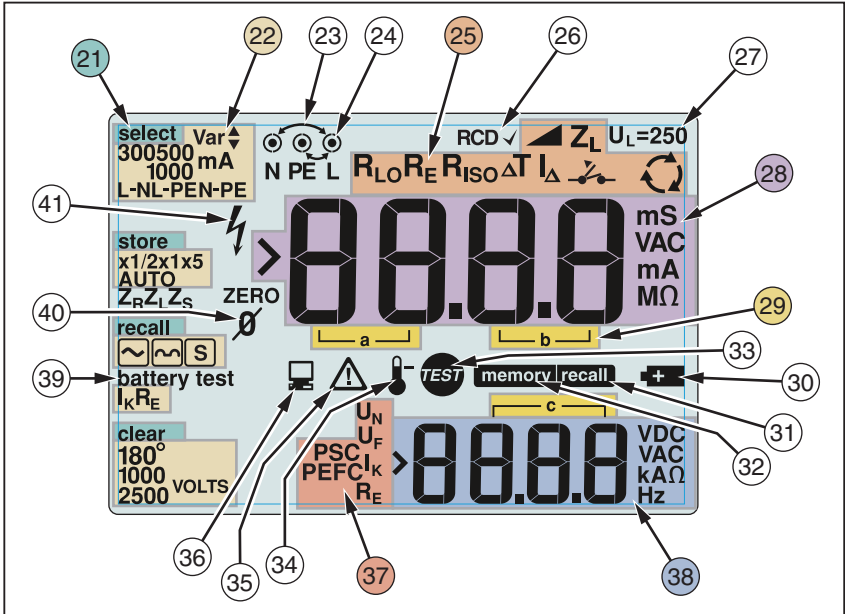

apx020f.eps

Figure 3. Models 1652C and 1653B Display Features

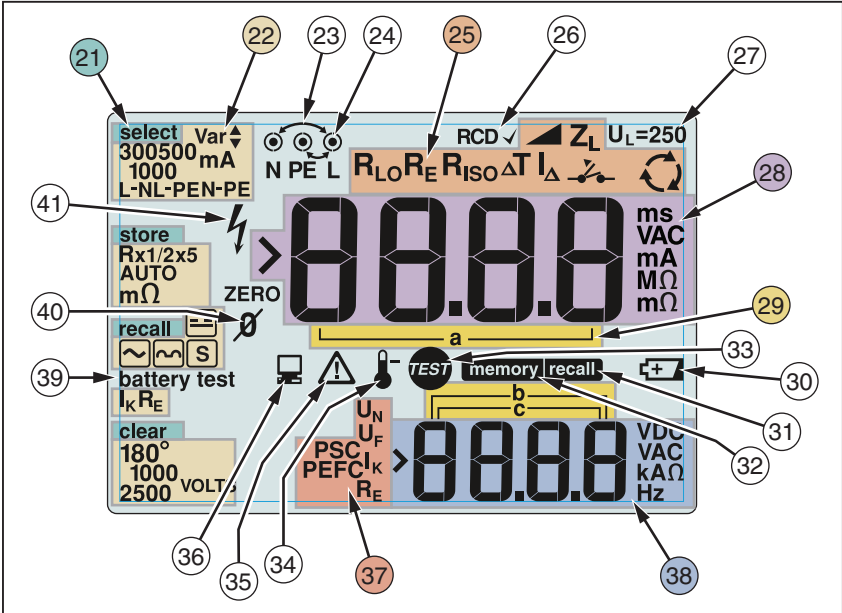

Figure 4. Model 1654B Display Features

apx120f.eps

Table 6. Display Features

No.	Annunciator	Meaning
21	select store recall clear	Displays the selected Memory mode. Memory modes are: Select (F1), Store (F2), Recall (F3), or Clear (F4).
22	300500 Var \updownarrow mA 1000 L-NL-PEN-PE store Rx1/2x5 AUTO mΩ recall \equiv \sim \sim S battery test Iκ RE clear 180° 1000 2500 VOLTS	Configuration options. Settings you can make within the measurement functions. For example, in the RCD Tripping Time function (ΔT) you can press (F2) to multiply the test current by x1/2, x1, x5 or AUTO and you can press (F3) to select the type of RCD you are testing.

Table 6. Display Features (cont.)









No.	Annunciator	Meaning
(23)		<p>Arrows above or below the terminal indicator symbol indicate reversed polarity. Check the connection or check the wiring to correct.</p>
(24)		<p>Terminal indicator symbol. A terminal indicator symbol with a dot (o) in the center indicates the terminal is used for the selected function. The terminals are:</p> <ul style="list-style-type: none"> • L (Line) • PE (Protective Earth) • N (Neutral)
(25)	<p> R_{LO} R_E R_{ISO} ΔT $I_{\Delta N}$  </p>	<p>Indicates the selected rotary switch setting. The measurement value in the primary display also corresponds to the switch setting. Rotary switch settings are:</p> <p>V Volts</p> <p>R_{ISO} Insulation</p> <p>R_{LO} Continuity</p> <p>Z₁  Loop no trip</p> <p>Z₁  Loop hi current trip</p> <p>ΔT  RCD trip time</p> <p>$I_{\Delta N}$  RCD trip current</p> <p>R_E Earth</p> <p> Phase Rotation</p>
(26)	<p>RCD ✓</p>	<p>Indicates that the measured trip current (trip current test) or the measured trip time (trip time test) is according to the appropriate RCD standard and the fault voltage is below the selected limit. For more information, see Maximum Trip Time Table on page 54.</p>

Table 6. Display Features (cont.)

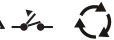



No.	Annunciator	Meaning
27	$U_L =$	<p>Indicates the preset fault voltage limit. The default setting is 50 V. Some locations require the fault voltage be set to 25 V, as specified by local electrical codes.</p> <p>Press F_4 when you turn on the tester to toggle the fault voltage between 25 V and 50 V. The value you set will appear on the display and will be saved when you turn the tester off.</p>
28		Primary display and measurement units.
29		Memory locations. See page 37 for detailed information on using memory locations.
30		Low battery icon. See “Testing and Replacing the Batteries” on page 41 for additional information on batteries and power management.
31		Appears when you press the Recall button and you are looking at stored data.
32		Appears when you press the Memory button.
33		Appears when you press the Test button. Disappears when the test is completed.

Table 6. Display Features (cont.)



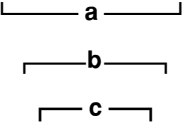



No.	Annunciator	Meaning
34		Appears when the instrument is overheated. The Loop test and RCD functions are inhibited when the instrument is overheated.
35		Appears when an error occurs. Testing is disabled. See “Error Codes” on page 16 for a listing and explanation of possible error codes.
36		Appears when the instrument is uploading data using Fluke PC software.
37	$ \begin{array}{c} U_N \\ U_F \\ PSC \\ PEFC \\ I_K \\ R_E \end{array} $	<p>Name of the secondary measurement function.</p> <p>U_N Test voltage for insulation test.</p> <p>U_F Fault voltage. Measures neutral to earth.</p> <p>PSC Prospective Short Circuit. Calculated from measured voltage and impedance when reading line to neutral.</p> <p>PEFC Prospective Earth Fault Current. Calculated from voltage and loop impedance which is measured line to protective earth.</p> <p>I_K In combination with the PSC or PEFC symbol, indicates a short circuit current.</p> <p>R_E Earth resistance.</p>

Table 6. Display Features (cont.)

No.	Annunciator	Meaning
<p>(38)</p>		<p>Secondary display and measurement units. Some tests will return more than one result or return a computed value based on the test result. This will occur with:</p> <ul style="list-style-type: none"> • Volts • Secondary display shows line frequency. • Insulation tests • Secondary display shows actual test voltage. • Loop/line impedance • Secondary display shows PEFC (Prospective Earth Fault Current) or R_E PSC (Prospective Short Circuit Current). • RCD switching time • Secondary display shows U_F fault voltage. • RCD tripping current • Secondary display shows U_F fault voltage.
	<p>battery test</p>	<p>Appears when you are testing the batteries. For more information see “Testing and Replacing the Batteries” on page 41.</p>
<p>(40)</p>	<p>ZERO </p>	<p>Appears when you press the  button to zero the leads. After the zeroing operation, the icon stays illuminated indicating that zeroing has been performed. Only used when performing continuity or loop testing.</p>
<p>(41)</p>		<p>Potential danger. Appears when measuring or sourcing high voltages.</p>

Input Terminals

Figure 5 shows the input terminals.

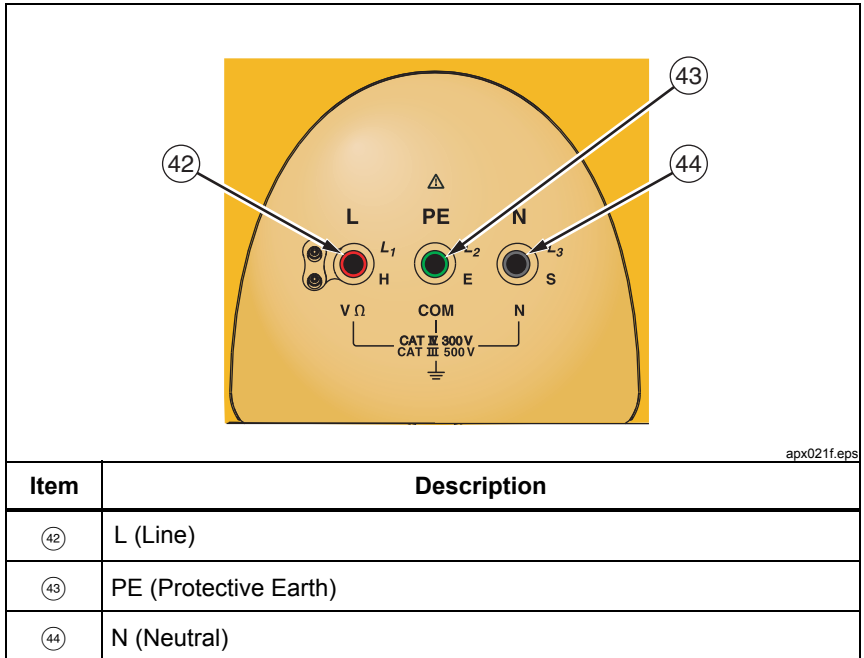

Figure 5. Input Terminals

Using the IR Port

The Model 1653B and 1654B have an IR (infrared) port, see Figure 23, which allows you to connect the tester to a computer and upload test data using a Fluke PC software product. This automates your troubleshooting or recording process, reduces the possibility of manual error and allows you to collect, organize, and display test data in a format that meets your needs. See “Uploading Test Results” on page 40 for additional information on using the IR port.

Error Codes

Various error conditions are detected by the tester and are indicated with the  icon, "Err", and an error number on the primary display. See Table 7. These error conditions disable testing and, if necessary, stop a running test.

Table 7. Error Codes

Error Condition	Code	Solution
Self-Test Fails	1	Return the tester to a Fluke Service Center.
Over-Temp	2	Wait while the tester cools down.
Fault Voltage	4	Check the installation, in particular, the voltage between N and PE.
Excessive Noise	5	Switch off all appliances (Loop, RCD measurements) and move the earth stakes (earth measurement).
Excessive Probe Resistance	6	Put the stakes deeper into the soil. Tamp down the soil directly around the stakes. Pour water around the stakes but not at the earth ground under test.

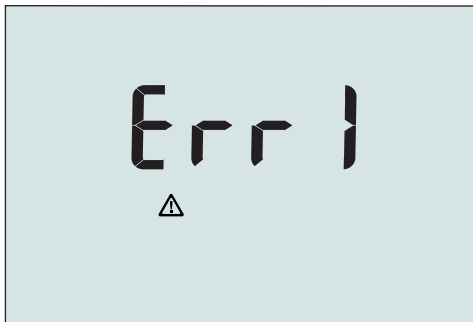

Figure 6. Error Display

apx032f.eps

Power-On Options



To select a power-on option, press  and the function key simultaneously and then release the  button. Power-on options are retained when the tester is turned OFF. See Table 8.

Table 8. Power-On Options













Keys	Power-On Options
 	<p>Loop/Line Impedance I_K limit. Toggles the I_K limit between 10 kA and 50 kA. The default is 10 kA.</p>
 	<p>Line and Neutral Swap mode. Two modes of operation are available. You can configure the tester to operate in L-n mode or L-n n-L mode, see Figure 7.</p> <ul style="list-style-type: none"> • In L-n mode, the L and N phase conductors must NEVER be reversed. This is a requirement in some regions including the UK. The  icon appears on the display indicating that the system L and N conductors are swapped and testing is inhibited. Investigate and rectify the cause of this system fault before proceeding. L-n mode also changes the RCD x1/2 trip time duration to 2 seconds as required in the UK. • In L-n n-L mode, the unit allows the L and N phase conductors to be swapped and testing will continue. <p style="text-align: center;"><i>Note</i></p> <p style="text-align: center;"><i>In locations where polarized plugs and outlets are used, a swapped lead icon () may indicate that the outlet was wired incorrectly. Correct this problem before proceeding with any testing.</i></p>
 	<p>Fault voltage limit. Toggles the fault voltage between 25 V and 50 V. The default is 50 V.</p>
 	<p>View the tester serial number. Primary display shows the initial four digits and the secondary display shows the next four digits.</p>

Table 8. Power-On Options (cont.)

Keys	Power-On Options
	Continuity beeper toggle. Toggles the continuity beeper on and off. The default is on.
	Extended documentation mode. Simultaneously press the Power button and the Up cursor key. Additional information is stored with an insulation test result (P/P, P/N, P/E, N/E) and with a continuity test result (R1+R2, R2, r1, r2, rn).

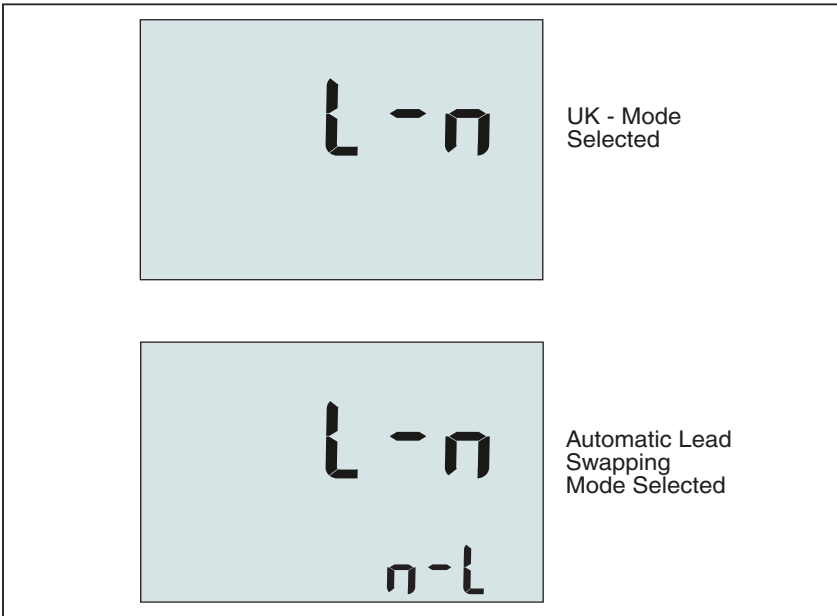

apx026f.eps

Figure 7. Lead Swapping Modes

Making Measurements

Measuring Volts and Frequency

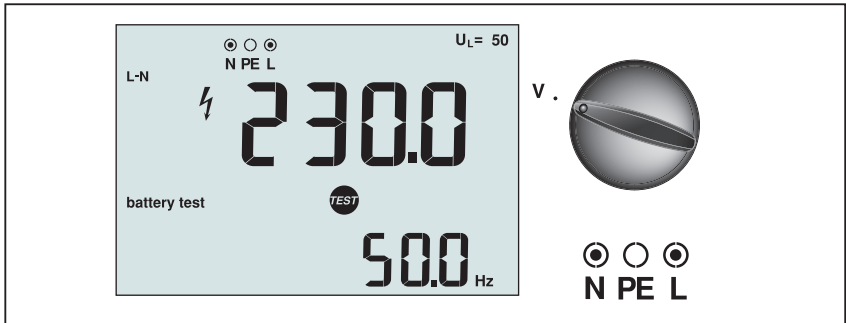

apx002f.eps

Figure 8. Volts Display/Switch and Terminal Settings

To measure voltage and frequency:

1. Turn the rotary switch to the V position.
2. Use all (red, blue, and green) terminals for this test. You can use test leads or mains cord when measuring AC voltage.
 - The primary (upper) display shows the AC voltage. The tester reads AC voltage to 500 V. Press (F1) to toggle the voltage reading between L-PE, L-N, and N-PE.
 - The secondary (lower) display shows mains frequency.

Measuring Insulation Resistance

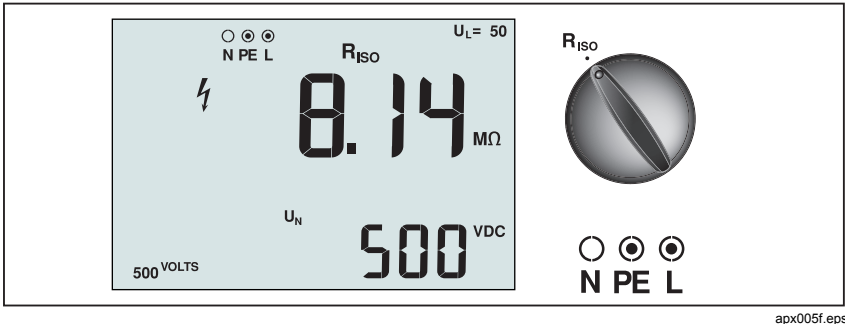

Figure 9. Insulation Resistance Display/Switch and Terminal Settings

⚠ ⚠ Warning

To avoid electric shock, measurements should only be performed on de-energized circuits.

To measure insulation resistance:

1. Turn the rotary switch to the R_{ISO} position.
2. Use the L and PE (red and green) terminals for this test.
3. Use the (FA) to select the test voltage. Most insulation testing is performed at 500 V, but observe local test requirements.
4. Press and hold (TEST) until the reading settles and the tester beeps.

Note

Testing is inhibited if voltage is detected in the line.

- The primary (upper) display shows the insulation resistance.
- The secondary (lower) display shows the actual test voltage.

Note

For normal insulation with high resistance, the actual test voltage (U_N) should always be equal to or higher than the programmed voltage. If insulation resistance is bad, the test voltage is automatically reduced to limit the test current to safe ranges.

Extended Documentation Mode

In the Extended Documentation mode, the Tester stores the measurement result with the measurement location: P/P, P/N, P/E or N/E. You can select the

information before or after the measurement with (F1). The definitions are: P/P = L, P/N = L-N, P/E = L-PE, N/E = N-PE.

Measuring Continuity

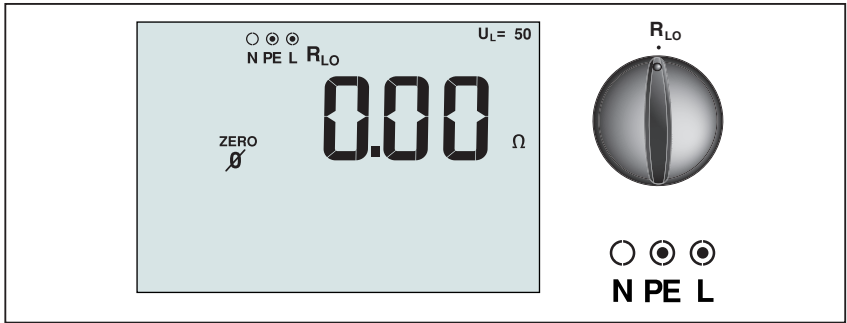

Figure 10. Continuity Zero Display/Switch and Terminal Settings

A continuity test is used to verify the integrity of connections by making a high resolution resistance measurement. This is especially important for checking Protective Earth connections.

Note

In countries where electrical circuits are laid out in a ring, it is recommended that you make an end-to-end check of the ring at the electrical panel.

⚠ ⚠ Warning

- **Measurements should only be performed on de-energized circuits.**
- **Measurements may be adversely affected by impedances or parallel circuits or transient currents.**

To measure continuity:

1. Turn the rotary switch to the R_{LO} position.
2. Use the L and PE (red and green) terminals for this test.
3. Before making a continuity test, use the Zero adapter to zero the test leads. Press and hold (ZERO) until the ZERO annunciator appears. The tester measures probe resistance, stores the reading in memory, and subtracts it from readings. The resistance value is saved even when power is turned off so you don't need to repeat the operation every time you use the instrument.

Note

Be sure the batteries are in good charge condition before you zero the test leads.

- Press and hold TEST until the reading settles. If the continuity beeper is enabled, the tester beeps continuously for measured values less than $2\ \Omega$ and there is no stable reading beep for measured values greater than $2\ \Omega$.
If a circuit is live, the test is inhibited and the AC voltage appears in the secondary (lower) display.

Extended Documentation Mode

In the Extended Documentation mode, the Tester stores the measurement result with the measurement location: R1+R2, R2, r1, r2 or rn. You can select the information before or after the measurement with F2 . The definitions are: R1+R2 = $R_x/2$, R2 = $R/2$, r1 = $x1$, r2 = $/2$, rn = $x5$.

Measuring Loop/Line Impedance

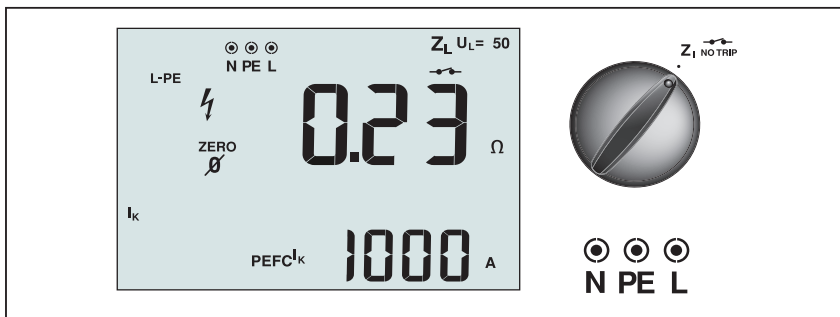



Figure 11. Loop/Line Impedance/Switch and Terminal Settings

Loop Impedance (Line to Protective Earth L-PE)

Loop impedance is source impedance measured between Line (L) and Protective Earth (PE). You can also ascertain the Prospective Earth Fault Current (PEFC) that is the current that could potentially flow if the phase conductor is shorted to the protective earth conductor. The tester calculates the PEFC by dividing the measured mains voltage by the loop impedance. The loop impedance function applies a test current that flows to earth. If RCDs are present in the circuit, they may trip. To avoid tripping, always use the Z₁ No Trip function on the rotary switch. The no trip test applies a special test that prevents RCDs in the system from tripping. If you are certain no RCDs are in the circuit, you can use the Z₁ Hi Current function for a faster test.

Note

If the L and N terminals are reversed, the tester will auto-swap them internally and continue testing. If the tester is configured for UK operation, testing will halt. This condition is indicated by arrows above or below the terminal indicator symbol (.

To measure loop impedance no trip mode:

  Warning





To prevent tripping RCDs in the circuit:

- **Always use the Z_1  position for loop measurements.**
- **Preload conditions can cause the RCD to trip.**
- **An RCD with a nominal fault current of 10 mA will trip.**

Note

To do a Loop impedance test in a circuit with a 10 mA RCD, we recommend a trip time RCD test. Use a nominal test current of 10 mA and the factor $\times \frac{1}{2}$ for this test.

If the fault voltage is below 25 V or 50 V, dependent on the local requirement, the loop is good. To calculate the loop impedance, divide the fault voltage by 10 mA (Loop impedance = fault voltage \times 100).

1. Turn the rotary switch to the Z_1  position.
2. Connect all three leads to the L, PE, and N (red, green, and blue) terminals of the tester.
3. Press  to select L-PE. The display shows the Z_L and  indicator.
4. Before you do a loop impedance test, use the zero adapter to zero the test leads or the mains cord. Press and hold  for more than two seconds until the ZERO annunciator appears. The tester measures the lead resistance, stores the reading in memory, and subtracts it from readings. The resistance value is saved even when the power is turned off so it is unnecessary to repeat the operation each time you use the tester with the same test leads or mains cord.

Note

Be sure the batteries are in good charge condition before you zero the test leads.

5. Connect all three leads to the L, PE, and N of the system under test or plug the mains cord into the socket under test.

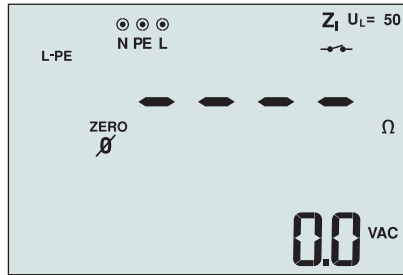

apx033f.eps

Figure 12. Display After Zeroing

6. Press and release TEST . Wait for the test to complete.
 The primary (upper) display shows the loop impedance.
7. To read the Prospective Earth Fault Current, press the F3 key and select I_k . The Prospective Earth Fault Current appears in amps or kilo amps in the secondary (lower) display.
8. If the mains is too noisy, Err 5 will be displayed. (The measured value accuracy is degraded by the noise.) Press the down arrow \downarrow to display the measured value. Press the up arrow \uparrow to return to the Err 5 display.

This test will take several seconds to complete. If the mains is disconnected while the test is active, the test automatically terminates.

Note

Errors may occur due to preloading the circuit under test.

To measure loop impedance—Hi current trip mode:

If no RCDs are present in the system under test, you can use the high current Line Earth (L-PE) loop impedance test.

1. Turn the rotary switch to the $Z_1 \Delta_{\text{TRIP}}$ position.
2. Connect all three leads to the L, PE, and N (red, green, and blue) terminals of the tester.
3. Press F1 to select L-PE. The \downarrow appears to indicate that hi current trip mode is selected.
4. Press F2 to select between Ω and $\text{m}\Omega$ resolution for the test results. The $\text{m}\Omega$ resolution test takes between 30 and 60 seconds to complete.
5. Repeat Steps 4 through 8 from the preceding test.

⚠ ⚠ Warning

The symbol  on the LCD indicates the high current loop mode - any RCDs in the system will trip - ensure there are no RCDs present.

Earth Resistance Testing by Loop Method

You can also use the tester to measure the earth resistance component of the total loop resistance. Check your local regulations to determine if this method is acceptable in your area. You can use three leads or the mains cord to perform this test. Use the connection shown in Figure 13 when making a 3-wire connection for earth resistance loop test. Zero the test leads (see sequence for Loop Impedance measurement).

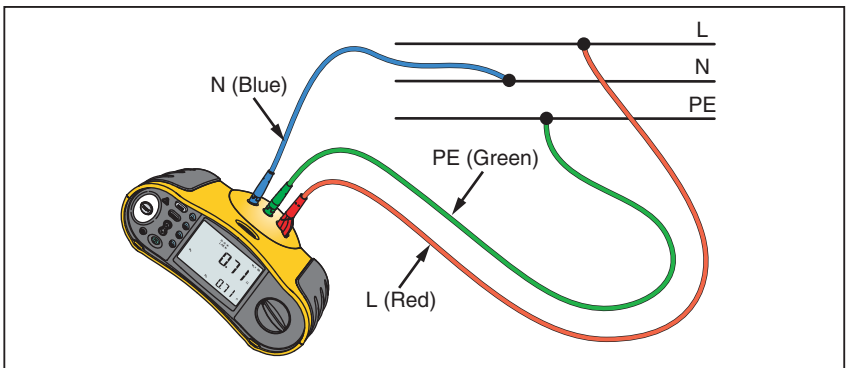

apx024f.eps

Figure 13. 3-Wire Connection for Earth Resistance Loop Test

To measure earth resistance using the loop test no trip mode:

1. Turn the rotary switch to the Z_1  position.
2. Press (F1) to select L-PE.
3. Press (F3) to select R_E (resistance).
4. Press and release (TEST). Wait for the test to complete.
 - The primary (upper) display shows the loop impedance.
 - The secondary (lower) display shows the earth resistance.

Line Impedance

Line impedance is source impedance measured between Line conductors or Line and Neutral. This function allows the following tests:

- Line to Neutral loop impedance.
- Line to Line impedance in 3-phase systems.

- L-PE loop measurement. This is a way of making a high current, 2-wire loop measurement. It cannot be used on circuits protected by RCDs because it will cause them to trip.
- Prospective Short Circuit Current (PSC). PSC is the current that can potentially flow if the phase conductor is shorted to the neutral conductor or another phase conductor. The tester calculates the PSC current by dividing the measured mains voltage by the line impedance.

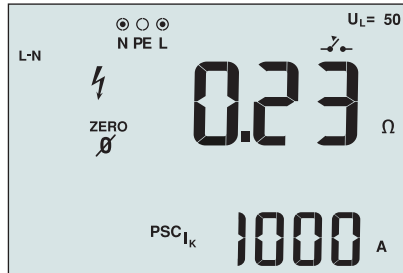

apx034f.eps

Figure 14. Line Impedance Display

To measure line impedance:

1. Turn the rotary switch to the Z_{L-PE} position. The LCD indicates that the high current loop mode is selected by displaying the lightning bolt symbol.
2. Connect the red lead to the L (red) and the blue lead to the N (blue) terminals of the tester.
3. Press (F1) to select L-N.
4. Press (F2) to select between Ω and $m\Omega$ resolution for the test results. The $m\Omega$ resolution test takes between 30 and 60 seconds to complete.
5. Use the zero adapter to zero the test leads or the mains cord.
6. Press and hold (ZERO) for more than two seconds until the ZERO annunciator appears.

The tester measures the lead resistance, stores the reading in memory, and subtracts it from readings. The resistance value is saved even when the power is turned off so it is unnecessary to repeat the operation each time you use the tester with the same test leads or mains cord.

Note

Be sure the batteries are in good charge condition before you zero the test leads.

⚠ ⚠ Warning

At this step, be careful not to select L-PE because a high current loop test will take place. Any RCDs in the system will trip if you proceed.

Note

Connect the leads in a single-phase test to the system live and neutral. To measure line-to-line impedance in a 3-phase system, connect the leads to 2 phases.

7. Press and release **TEST**. Wait for the test to complete.
 - The primary (upper) display shows the line impedance.
 - The secondary (lower) display shows the Prospective Short Circuit Current (PSC).
8. If the mains is too noisy, Err 5 will be displayed. (The measured value accuracy is degraded by the noise). Press the down arrow **⏴** to display the measured value. Press the up arrow **⏵** to return to the Err 5 display.

Use the connection shown in Figure 15 when measuring in a 3-phase 500 V system.

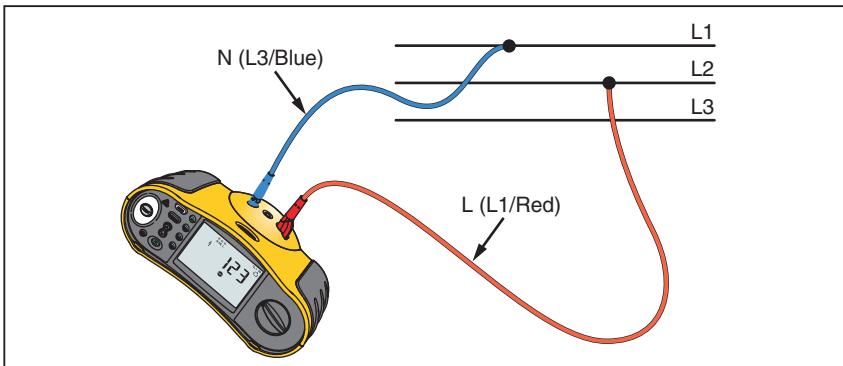

Figure 15. Measuring in a 3-Phase System

apx025f.eps

Measuring RCD Tripping Time

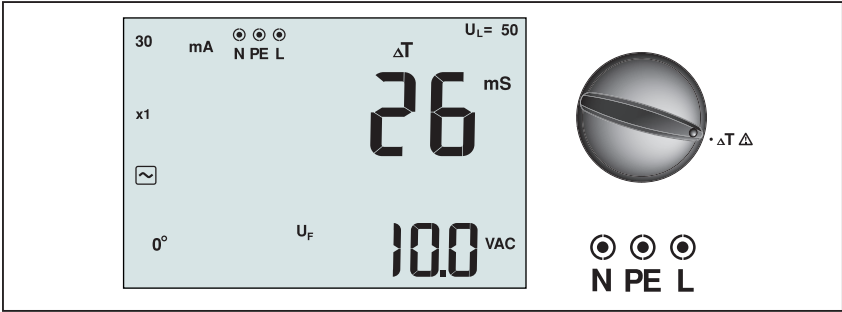

Figure 16. RCD Tripping Time Display/Switch and Terminal Settings

In this test, a calibrated fault current is induced into the circuit, causing the RCD to trip. The meter measures and displays the time required for the RCD to trip. You can perform this test with test leads or using the mains cord. The test is performed with a live circuit.

You can also use the tester to perform the RCD tripping time test in Auto mode, which makes it easier for one person to perform the test. If the RCD has a special nominal current setting other than the standard options, 10, 30, 100, 300, 500 1000 mA, you can use a custom setting with the VAR mode.

Note

When measuring trip time for any type of RCD, the tester first does a pretest to determine if the actual test will cause a fault voltage exceeding the limit (25 or 50 V).

To avoid having an inaccurate trip time for S type (time delay) RCDs, a 30 second delay is activated between the pretest and the actual test. This RCD type needs a delay because it contains RC circuits that are required to settle before applying the full test.

⚠ ⚠ Warning

- **Test the connection between the N-conductor and earth before starting the test. A voltage between the N-conductor and earth may influence the test.**
- **Leakage currents in the circuit following the residual current protection device may influence measurements.**
- **The displayed fault voltage relates to the rated residual current of the RCD.**

- **Potential fields of other earthing installations may influence the measurement.**
- **Equipment (motors, capacitors) connected downstream of the RCD may cause considerable extension of the tripping time.**

Note

If the L and N terminals are reversed, the tester will auto-swap them internally and continue testing. If the tester is configured for UK operation, testing will halt and you will need to determine why the L and N are swapped. This condition is indicated by arrows above or below the terminal indicator symbol ($\ominus \circ \ominus$).

Type A and type B RCDs do not have the 1000 mA option available.

To measure RCD tripping time:





1. Turn the rotary switch to the ΔT position.
2. Press F1 to select the RCD current rating (10, 30, 100, 300, 500, or 1000 mA).
3. Press F2 to select a test current multiplier (x ½, x 1, x 5, or Auto). Normally you will use x 1 for this test.
4. Press F3 to select the RCD test-current waveform:
 - \sim – AC current to test type AC (standard AC RCD) and type A (pulse-DC sensitive RCD)
 - \sim – Half-wave current to test type A (pulse-DC sensitive RCD)
 - \sim S – Delayed response to test S-type AC (time delayed AC RCD)
 - \sim S – Delayed response to S-type A (time delayed pulse-DC sensitive RCD)
 - = – Smooth-DC current to test type B RCD
 - = S – Delayed response to S-type B (time delayed smooth-DC current RCD)
5. Press F4 to select the test current phase, 0° or 180°. RCDs should be tested with both phase settings, as their response time can vary significantly depending on the phase.

Note

For RCD type B (=) or S-type B (= S), you must test with both phase settings.

6. Press and release . Wait for the test to complete.
 - The primary (upper) display shows the trip time.
 - The secondary (lower) display shows the fault voltage (N to PE) related to the rated residual current.
 - If the trip time is according to the appropriate standard of the RCD, the RCD ✓ indicator displays. For more information, see Maximum Trip Time Table on page 54.





To measure RCD tripping time for a custom RCD setting – VAR mode:

1. Turn the rotary switch to the ΔT position.
2. Press  to select the VAR current rating. The current custom setting shows on the primary display. Use the  arrow keys to adjust the value.
3. Press  to select a test current multiplier. Normally you will use x 1/2 or x 1 for this test.
4. Repeat steps 4 through 6 listed in the preceding RCD tripping time procedure.
5. To view the nominal setting used for the test, depress the  arrow key.

Note



The maximum setting for type A RCDs is 700 mA. VAR mode is not available for type B RCDs.

To measure RCD tripping time using Auto mode:

1. Plug the tester into the outlet.
2. Turn the rotary switch to the ΔT position.
3. Press  to select the RCD current rating (10, 30, or 100 mA).
4. Press  to select Auto mode.
5. Press  to select the RCD test-current waveform.
6. Press and release .

The tester supplies $\frac{1}{2}x$ the rated RCD current for 310 or 510 ms (2 seconds in the UK). If the RCD trips, the test terminates. If the RCD does not trip, the tester reverses phase and repeats the test. The test terminates if the RCD Trips.

If the RCD does not trip, the tester restores the initial phase setting and supplies $1x$ the rated RCD current. The RCD should trip and the test results appear in the primary display.

7. Reset the RCD.
8. The tester reverses phases and repeats the 1x test. The RCD should trip and the test results appear in the primary display.
9. Reset the RCD.
10. The tester restores the initial phase setting and supplies 5x the rated RCD current for up to 50 ms. The RCD should trip and the test results appear in the primary display.
11. Reset the RCD.
12. The tester reverses phase and repeats the 5x test. The RCD should trip and the test results appear in the primary display.
13. Reset the RCD.
 - You can use the  arrow keys to review test results. The first result shown is the last measurement taken, the 5x current test. Press the down arrow key  to move backward to the first test at 1/2x the rated current.
 - If the trip time is according to the appropriate standard of the RCD, the RCD ✓ indicator displays. For more information, see Maximum Trip Time Table on page 54.
14. Test results are in temporary memory. If you want to store the test results, press  and proceed as described in “Storing and Recalling Measurements” on page 37 of this manual. Measurement storage and recall is available only on Models 1653B and 1654B.

Note

You must store each result separately after you select it with the arrow keys.

Measuring RCD Tripping Current

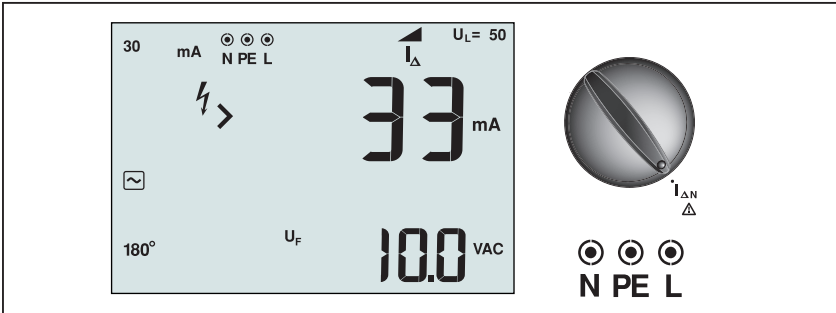

Figure 17. RCD Tripping Current/Switch and Terminal Settings

apx009f.eps

This test measures the RCD tripping current by applying a test current and then gradually increasing the current until the RCD trips. You can use the test leads or mains cord for this test. A 3-wire connection is required.

⚠ ⚠ Warning

- Test the connection between the N-conductor and earth before starting the test. A voltage between the N-conductor and earth may influence the test.
- Leakage currents in the circuit following the residual current protection device may influence measurements.
- The displayed fault voltage relates to the rated residual current of the RCD.
- Potential fields of other earthing installations may influence the measurement.

Note







If the L and N terminals are reversed, the tester will auto-swap them internally and continue testing. If the tester is configured for UK operation, testing will halt and you will need to determine why the L and N are swapped. This condition is indicated by arrows above or below the terminal indicator symbol (⊖⊖⊖).

Type A and type B RCDs do not have the 1000 mA option available.



To measure RCD tripping current:

1. Turn the rotary switch to the $I_{\Delta N}$ position.
2. Press (F) to select the RCD current rating (10, 30, 100, 300, or 500 mA). If the RCD has a special nominal current setting other than the standard

options, 10, 30, 100, 300, 500 1000 mA, you can use a custom setting with the VAR mode.



3. Press **F3** to select the RCD test-current waveform:
 -  – AC current to test type AC (standard AC RCD) and type A (pulse-DC sensitive RCD)
 -  – Half-wave current to test type A (pulse-DC sensitive RCD)
 -  **S** – Delayed response to test S-type AC (time delayed AC RCD)
 -  **S** – Delayed response to S-type A (time delayed pulse-DC sensitive RCD)
 -  – Smooth-DC current to test type B RCD
 -  **S** – Delayed response to S-type B (time delayed smooth-DC current RCD)
4. Press **F4** to select the test current phase, 0° or 180°. RCDs should be tested with both phase settings, as their response time can vary significantly depending on the phase.

Note

*For RCD type B () or S-type B ( **S**), you must test with both phase settings.*

5. Press and release **TEST**. Wait for the test to complete.
 - The primary (upper) display shows the RCD trip current.
 - If the trip current is according to the appropriate standard of the RCD, the RCD ✓ indicator displays. For more information, see Maximum Trip Time Table on page 54.

To measure RCD tripping current for a custom RCD setting - VAR mode:

1. Turn the rotary switch to the $I_{\Delta N}$ position.
2. Press **F1** to select the VAR current rating. The current custom setting shows on the primary display. Use the  arrow keys to adjust the value.
3. Repeat steps 3 through 5 listed in the preceding RCD tripping current procedure.
4. To view the nominal test setting, depress the  arrow key.

Note

The maximum setting for RCDs is 700 mA. VAR mode is not available for type B RCDs.

RCD Testing in IT Systems

RCD testing at locations with IT systems requires a special test procedure because the Protective Earth connection is grounded locally and is not tied directly to the power system.

The test is conducted at the electrical panel using probes. Use the connection shown in Figure 18 when performing RCD testing on IT electrical systems.

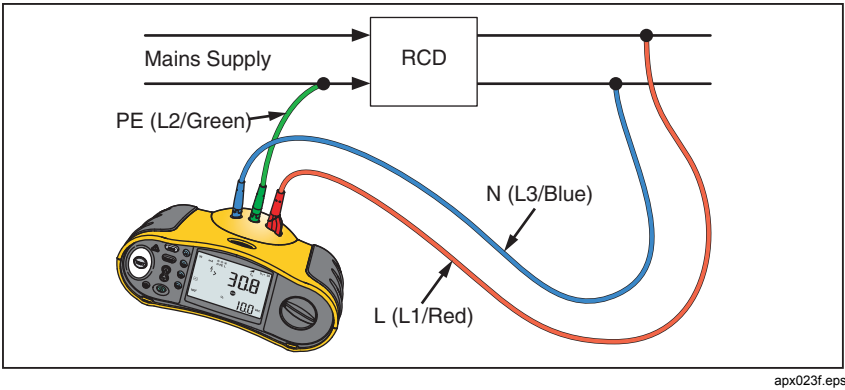

Figure 18. Connection for RCD Testing on IT Electrical Systems

The test current flows through the upper side of the RCD, into the L terminal, and returns through the PE terminal.

Measuring Earth Resistance (Model 1653B and 1654B Only)

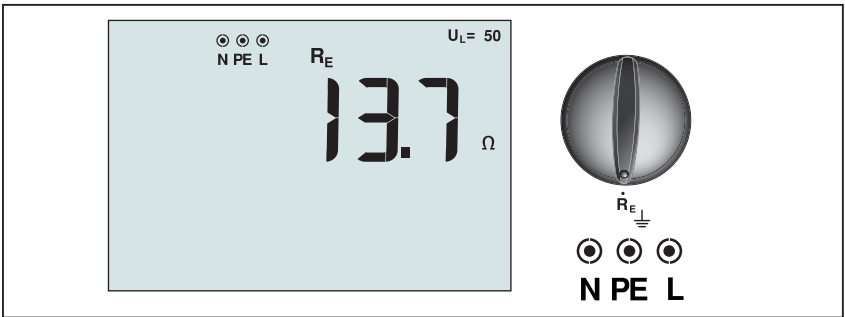
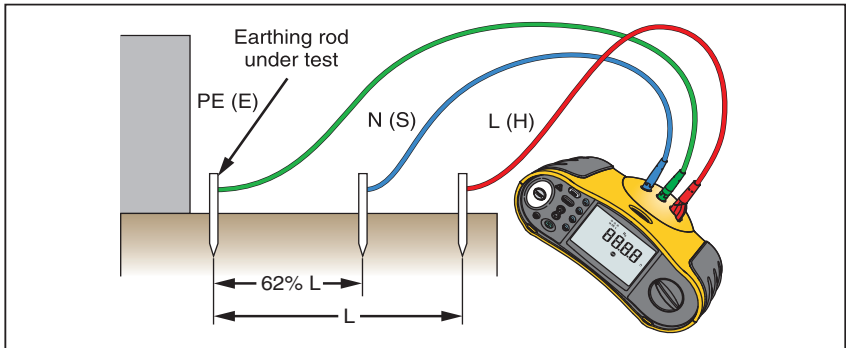

Figure 19. Earth Resistance Display/Switch and Terminal Settings

The earth resistance test is a 3-wire test consisting of two test stakes and the earth electrode under test. This test requires an accessory stake kit. Connect as shown in Figure 20.

- Best accuracy is achieved with the middle stake at 62 % of the distance to the far stake. The stakes should be in a straight line and wires separated to avoid mutual coupling.
- The earth electrode under test should be disconnected from the electrical system when conducting the test. Earth resistance testing should not be performed on a live system.



apx014f.eps

Figure 20. Earth Resistance Test Connection

To measure earth resistance:

1. Turn the rotary switch to the R_E position.
2. Press and release TEST . Wait for the test to complete.
 - The primary (upper) display shows the earth resistance reading.
 - Voltage detected between the test rods will be displayed in the secondary display. If greater than 10 V, the test is inhibited.
 - If the measurement is too noisy, Err 5 will be displayed. (The measured value accuracy is degraded by the noise). Press the down arrow (\downarrow) to display the measured value. Press the up arrow (\uparrow) to return to the Err 5 display.
 - If the probe resistance is too high, Err 6 is displayed. Probe resistance may be reduced by driving the test stakes further into the earth or wetting the earth around the test stakes.

Testing Phase Sequence

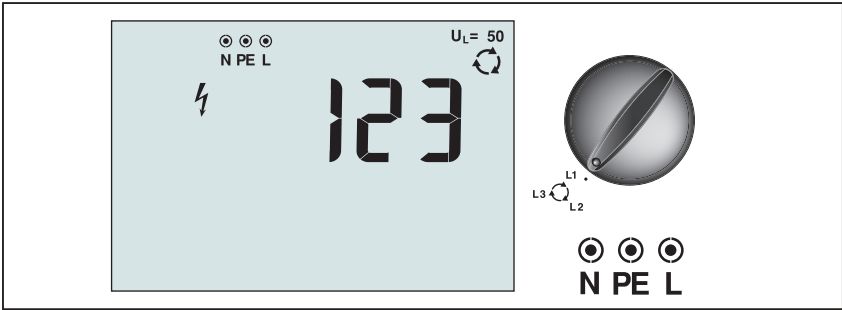

Figure 21. Phase Sequence Display/Switch and Terminal Settings

apx011f.eps

Use the connection shown in Figure 22 for a phase sequence test connection.

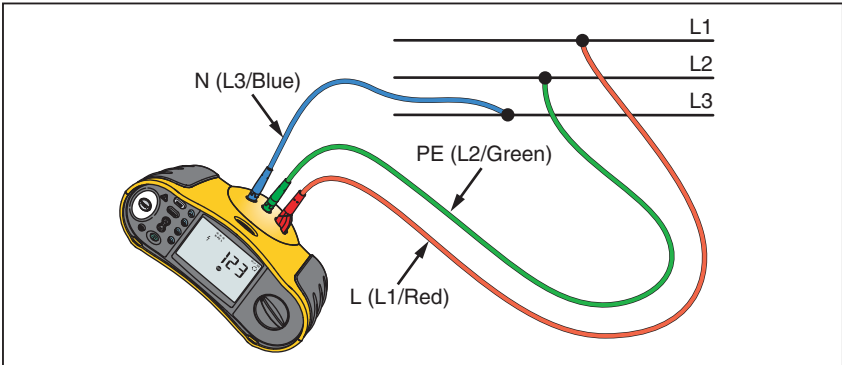



Figure 22. Phase Sequence Test Connection

apx022f.eps

To perform a phase sequence test:

1. Turn the rotary switch to the  position.
2. The primary (upper) display shows:
 - 123 for correct phase sequence.
 - 321 for reversed phase sequence.
 - Dashes (---) instead of numbers if insufficient voltage is sensed.

Memory Mode

(Model 1653B and 1654B Only)

You can store measurements on the tester:

- 1653B – up to 444
- 1654B – up to 1500

The information stored for each measurement consists of the test function and all user selectable test conditions.

Data for each measurement is assigned a data set number, data subset number, and a data id number. Memory location fields are used as described below.



Field	Description
┌─── a ──┐	Use the data set field (a) to indicate a location such as a room or electrical panel number.
┌─── b ──┐	Use the data subset field (b) for circuit number.
┌─── c ──┐	The data id number field (c) is the measurement number. The measurement number automatically increments. The measurement number can also be set to a previously used value to overwrite an existing measurement.

To enter Memory mode:

1. Press the  to enter Memory mode.

The display changes to a memory mode display. In Memory mode, the **memory** icon appears on the display.

1653B: The primary numeric display will be active with the left two digits (a) indicating the data set number (1-99) and the right two digits (b) indicating the data subset number. The decimal point separating these two values will be active. The secondary numeric display (c) will be active indicating the data id number (1-444). One of the memory locations, a, b, or c, will flash to indicate that you can change the number using the arrow keys .

1654B: The primary numeric display shows the data set number (a, 1-9999). The secondary numeric display shows the data subset number (b, 1-9999). The data id number (c, 1-9999) appears after you press  several times. One of the memory locations, a, b, or c, will flash to indicate that you can change the number using the arrow keys .

2. To enable the data subset number to be changed, press **F1**. The data subset number will now be flashing. To enable the data sub number to be changed, press **F1** again. The data set number will now be flashing. Press **F1** again to change the data id number.
3. Press the down arrow key (**↓**) to decrement the enabled number or press the up arrow key (**↑**) to increment the enabled number. For storing data, the number can be set to any value, overwriting existing data is allowed. For recalling data, the number can only be set to used values.

Note

*If you press the up or down arrow key (**↑** or **↓**) once, the number increments or decrements by one. To accelerate the increment or decrement function, press and hold the up or down arrow.*

Storing a Measurement

To store a measurement:

1. Press **MEMORY** to enter Memory mode.
2. Press **F1** and use the arrow keys (**↑** or **↓**) to set the data identity.
3. Press **F2** to save the data.
 - If memory is full, FULL will appear on the primary display. Press **F1** to choose another data identity, press **MEMORY** to exit Memory mode.
 - If the memory is not full, the data will be saved, the tester will automatically exit Memory mode and the display will revert back to the previous test mode.
 - If the data identity has been previously used, the display will show STO? Press **F2** again to store the data, press **F1** to choose another data identity, press **MEMORY** to exit Memory mode.

Extended documentation mode:

For insulation and continuity tests, you can store additional information with the measurement result. For more information, see "*Measuring Insulation Resistance*" and "*Measuring Continuity*".

Recalling a Measurement

To recall a measurement:

1. Press **MEMORY** to enter the Memory mode.
2. Press **F3** to enter the Recall mode.
3. Use **F1** and the arrow keys (**↑** or **↓**) to set the data identity. If no data has been saved, all fields will be dashes.

4. Press **F3** to recall the data. The tester display will revert to the Test mode used for the recalled test data, however, the **memory** icon still appears, indicating the tester is still in Memory mode.
5. Press **F3** to toggle between the data id screen and the recalled data screen to check the recalled data id or to select more data to recall.
6. Press **MEMORY** to exit Memory mode at any time.

Clearing Memory

To clear all memory in 1653B:

1. Press **MEMORY** to enter Memory mode.
2. Press **F4**. The primary display will show Clr?
3. Press **F4** again to clear all memory locations. The Tester returns to the measurement mode.

To clear all memory in 1654B:

1. Press **MEMORY** to enter Memory mode.
2. Press **F4**. The primary display will show Clr?

Note

*If either the data set (a) or the subset number (b) changes since the last stored result, the display shows the data set (a) and subset number (b) of the last stored result. Press **F4** again to show “Clr?” and the data ID (c).*

3. Press **F3** to enable clear all memory. The display shows Clr All?
4. Press **F4** to confirm clear all memory. All memory is cleared and the Tester returns to the measurement mode.

To delete (clear) the last valid stored result in 1654B:

1. Press **MEMORY** to enter Memory mode. The display shows the last date set (a) and data subset (b) selections.
2. Press **F4**. The primary display will show Clr? and the data ID (c).

Note

*If either the data set (a) or the subset number (b) changes since the last stored result, the display shows the data set (a) and subset number (b) of the last stored result. Press **F4** again to show “Clr?” and the data ID (c).*

3. Press **F4** to delete the last valid stored result. The display shows the next last valid id number (c) for a short time and then the Tester returns to the measurement mode.

Uploading Test Results (Model 1653B and 1654B Only)

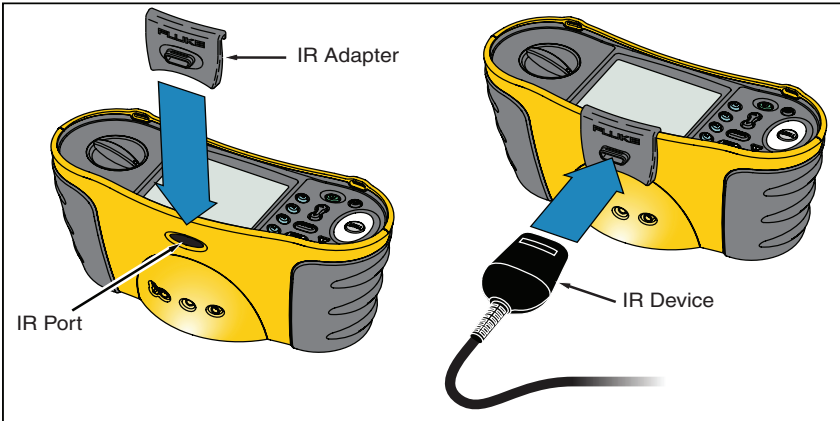

Figure 23. Attaching the IR Adapter

apx031f.eps

To upload test results:

1. Connect the IR serial cable to the serial port on the PC.
2. Attach the IR adapter and the device to the tester as shown in Figure 23. Be sure to align the IR adapter to the IR port on the tester.

Note

*The IR data port is disabled when test leads are plugged in.
Disconnect test leads before attempting to upload test results.*

3. Start the Fluke PC software program.
4. Press $\text{\textcircled{1}}$ to turn on the tester.
5. Refer to the software documentation for complete instructions on how to set the date/time stamp and upload data from the tester.

Maintaining the Tester

Cleaning

Periodically wipe the case with a damp cloth and mild detergent. Do not use abrasives or solvents.

Dirt or moisture in the terminals can affect readings.

To clean the terminals:

1. Turn the meter off and remove all test leads.
2. Shake out any dirt that may be in the terminals.
3. Soak a new swab with alcohol. Work the swab around each terminal.

Testing and Replacing the Batteries

Battery voltage is continuously monitored by the tester. If the voltage falls below 6.0 V (1.0 V/cell), the low battery icon  appears on the display, indicating that there is minimal battery life left. The low battery icon continues to appear on the display until you replace the batteries.

Warning

To avoid false readings, which could lead to possible electric shock or personal injury, replace the batteries as soon as the battery icon () appears.

Be sure that the battery polarity is correct. A reversed battery can cause leakage.

Replace the batteries with six AA batteries. Alkaline batteries are supplied with the tester but you can also use 1.2 V NiCd or NiMH batteries. You can also check the battery charge so that you can replace them before they discharge.

Warning

To avoid electrical shock or personal injury, remove the test leads and any input signals before replacing the battery. To prevent damage or injury, install ONLY specified replacement fuses with the amperage, voltage, and speed ratings shown in the General Specifications section of this manual.

To test the batteries:

1. Turn the rotary switch to the V position.
2. Press  to initiate the battery test. The Voltage function display clears and is replaced by the measured battery voltage in the secondary display for 2 seconds, the Voltage function display then returns.

To replace the batteries (refer to Figure 24):

1. Press  to turn the tester off.
2. Remove the test leads from the terminals.
3. Remove the battery door by using a standard-blade screwdriver to turn the battery door screws (3) one-quarter turn counterclockwise.
4. Press the release latch and slide the battery holder out of the tester.
5. Replace the batteries and the battery door.

Note

All stored data will be lost if the batteries are not replaced within approximately one minute (Models 1653B and 1654B only).

6. Secure the door by turning the screws one-quarter turn clockwise.

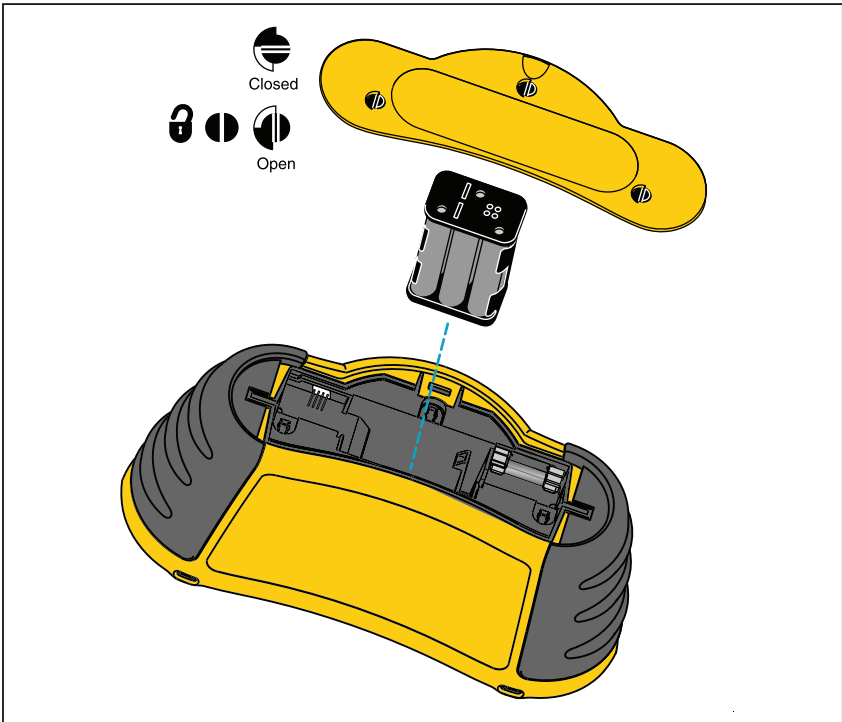

Figure 24. Replacing the Batteries

apx028f.eps

Testing the Fuse

A fuse test is performed each time you turn on the tester. If leads are plugged into the L and PE terminals, the fuse test is skipped. If a blown fuse is detected, testing is disabled, FUSE appears on the primary display, and the tester issues a warning beep.

You can also perform a manual check of the fuse.

To manually check the fuse:

1. Turn the rotary switch to either **R_{ISO}** or **R_{LO}** switch setting.
2. Short the leads and press and hold .
3. If the fuse is bad, FUSE will appear on the display to indicate the tester is damaged and needs repair. Contact Fluke Service for repair (see *Contacting Fluke*).

Specifications

Features by Model

Measurement Function	1652C	1653B	1654B
Voltage & Frequency	√	√	√
Wiring polarity checker	√	√	√
Insulation Resistance	√	√	√
Continuity & Resistance	√	√	√
Loop & Line Resistance	√	√	√
Loop & Line Resistance—mΩ resolution			√
Prospective Earth Fault Current (PEFC/I _K) Prospective Short-Circuit current (PSC/I _K)	√	√	√
RCD switching time	√	√	√
RCD tripping level	√ ramp test	√ ramp test	√ ramp test
RCD variable current	√	√	√
Automatic RCD test sequence	√	√	√
Test pulse current sensitive RCDs (Type A)	√	√	√
Test smooth dc sensitive RCDs (Type B)			√
Earth Resistance		√	√
Phase Sequence Indicator	√	√	√
Other Features			
Self-test	√	√	√
Illuminated Display	√	√	√
Memory		√	√
Memory, Interface			
Extended Memory			√
Computer Interface		√	√
Time and date (When used with FlukeView software)		√	√
Software		√	√
Included Accessories			
Hard case	√	√	√
Remote control probe	√	√	√
Zero Adapter	√	√	√

General Specifications

Specification	Characteristic
Size	10 cm (L) x 25 cm (W) x 12.5 cm (H)
Weight (with batteries)	1.3 kg
Battery size, quantity	Type AA, 6 ea.
Battery type	Alkaline supplied. Usable with 1.2 V NiCd or NiMH batteries (not supplied)
Battery life (typical)	200 hours idling
Fuse	T3.15 A, 500 V, 1.5 kA 6.3 x 32 mm (PN 2030852)
Operating Temperature	-10 °C to 40 °C
Storage Temperature	-10 °C to 60 °C indefinitely (to -40 °C for 100 hrs)
Relative Humidity	80 % 10 to 35 °C; 70 % 35 to 40 °C
Operating Altitude	0 to 2000 meters
Shock, Vibration	Vibration to Class 3 per Mil-Prf-28800F 1 meter drop test, six sides, oak floor
Sealing	IP 40
EMC	Complies with EN61326-1: 2006
Safety	Complies with EN61010-1 Ed 2.0 (2001-02), UL61010, ANSI/ISA –s82.02.01 2000 and CAN/CSA c22.2 No.1010 2 nd edition Overvoltage Category: 500 V/CAT III 300 V/CAT IV Measurement Category III is for measurements performed in the building installation. Examples are distribution panels, circuit breakers, wiring and cabling. Category IV equipment is designed to protect against transients from the primary supply level, such as an electrical meter or an overhead or underground utility service. Performance EN61557-1, EN61557-2, EN61557-3, EN61557-4, EN61557-5, EN61557-6, EN61557-7 Second edition. EN61557-10 First edition.
Pollution Degree	2
Maximum voltage between any terminal and earth ground	500 V
Surge Protection	6 kV peak per EN 61010-1 Ed. 2.0 (2001-02)

Category Ratings and Usage

Part/Accessory	Printed CAT Rating	CAT II 250 V	CAT III 500 V	CAT IV 300 V
Electrical Installation Tester	CAT III 500 V CAT IV 300 V	√ √	√ √	√ √
Country-Specific Mains Cord	CAT II 250 V	√		
Multifunction Probe (red)	CAT III 1000 V	√	√	√
Test Lead (red/green/blue)	CAT III 1000 V	√	√	√
Test Probe (red/green/blue)	CAT III 1000 V	√	√	√
Alligator Clip (red/green/blue)	CAT III 1000 V	√	√	√
UK Test Leads and Probes: Non-fused (red/green/blue) Fused (red/green/blue)	CAT III 1000 V CAT III 600 V	√ √	√ √	√ √

Electrical Measurement Specifications

The accuracy specification is defined as $\pm(\% \text{ reading} + \text{digit counts})$ at $23\text{ °C} \pm 5\text{ °C}$, $\leq 80\%$ RH. Between -10 °C and 18 °C and between 28 °C and 40 °C , accuracy specifications may degrade by $0,1 \times$ (accuracy specification) per °C . The following tables can be used for the determination of maximum or minimum display values considering maximum instrument operating uncertainty per EN61557-1, 5.2.4.

Insulation Resistance (R_{ISO})

50 V		100 V		250 V		500 V		1000 V	
Limit Value	Maximum Display Value	Limit Value	Maximum Display Value	Limit Value	Maximum Display Value	Limit Value	Maximum Display Value	Limit Value	Maximum Display Value
1	1.12	1	1.12	1	1.3	1	1.3	1	1.3
2	2.22	2	2.22	2	2.4	2	2.4	2	2.4
3	3.32	3	3.32	3	3.5	3	3.5	3	3.5
4	4.42	4	4.42	4	4.6	4	4.6	4	4.6
5	5.52	5	5.52	5	5.7	5	5.7	5	5.7
6	6.62	6	6.62	6	6.8	6	6.8	6	6.8
7	7.72	7	7.72	7	7.9	7	7.9	7	7.9
8	8.82	8	8.82	8	9.0	8	9.0	8	9.0
9	9.92	9	9.92	9	10.1	9	10.1	9	10.1
10	11.02	10	11.02	10	11.2	10	11.2	10	11.2
20	22.02	20	22.02	20	22.2	20	22.2	20	22.2
30	33.02	30	33.2	30	33.2	30	33.2	30	33.2
40	44.02	40	44.2	40	44.2	40	44.2	40	44.2

Insulation Resistance (R_{ISO}) (cont.)

50	55.02	50	55.2	50	55.2	50	55.2	50	55.2
		60	66.2	60	66.2	60	66.2	60	66.2
		70	77.2	70	77.2	70	77.2	70	77.2
		80	88.2	80	88.2	80	88.2	80	88.2
		90	99.2	90	99.2	90	99.2	90	99.2
		100	110.2	100	110.2	100	110.2	100	110.2
				200	220.2	200	220.2	200	220.2
						300	347	300	345
						400	462	400	460
						500	577	500	575
								600	690
								700	805
								800	920
								900	1035
								1000	1150

Continuity (R_{LO})

Limit Value	Maximum Display Value	Limit Value	Maximum Display Value
0.2	0.16	3	2.68
0.3	0.25	4	3.58
0.4	0.34	5	4.48
0.5	0.43	6	5.38
0.6	0.52	7	6.28
0.7	0.61	8	7.18
0.8	0.7	9	8.08
0.9	0.79	10	8.98
1	0.88	20	17.98
2	1.78	30	26.8

Loop Tests (Z_i)

Loop Z _i Hi Current		Loop Z _i No Trip		Loop Z _i		Loop R _E	
Limit Value	Maximum Display Value	Limit Value	Maximum Display Value	Limit Value	Maximum Display Value	Limit Value	Maximum Display Value
0.20	0.14	-	-	3	2.53	3	2.72
0.30	0.23	-	-	4	3.38	4	3.62
0.40	0.32	0.40	0.28	5	4.23	5	4.52
0.50	0.41	0.50	0.37	6	5.08	6	5.42
0.60	0.50	0.60	0.45	7	5.93	7	6.32
0.70	0.59	0.70	0.54	8	6.78	8	7.22
0.80	0.68	0.80	0.62	9	7.63	9	8.12
0.90	0.77	0.90	0.71	10	8.48	10	9.02
1.00	0.86	1.00	0.79	20	16.98	20	18.02
1.10	0.95	1.10	0.88	30	25.3	30	27.2
1.20	1.04	1.20	0.96	40	33.8	40	36.2
1.30	1.13	1.30	1.05	50	42.3	50	45.2
1.40	1.22	1.40	1.13	60	50.8	60	54.2
1.50	1.31	1.50	1.22	70	59.3	70	63.2
1.60	1.40	1.60	1.30	80	67.8	80	72.2
1.70	1.49	1.70	1.39	90	76.3	90	81.2
1.80	1.58	1.80	1.47	100	84.8	100	90.2
1.90	1.67	1.90	1.56	200	169.8	200	180.2
2.00	1.76	2.00	1.64	300	253	300	272
-	-	-	-	400	338	400	362
-	-	-	-	500	423	500	452
-	-	-	-	600	508	600	542
-	-	-	-	700	593	700	632
-	-	-	-	800	678	800	722
-	-	-	-	900	763	900	812
-	-	-	-	1000	848	1000	902

RCD/FI Tests (ΔT , $I_{\Delta N}$)

RCD/FI Time		RCD/FI Current	
Limit Value	Maximum Display Value	Limit Value	Maximum Display Value
20	18.1	0.5	0.43
30	27.1	0.6	0.52
40	36.1	0.7	0.61
50	45.1	0.8	0.7
60	54.1	0.9	0.79
70	63.1	1	0.88
80	72.1	2	1.78
90	81.1	3	2.68
100	90.1	4	3.58
200	180.1	5	4.48
300	271	6	5.38
400	361	7	6.28
500	451	8	7.18
600	541	9	8.08
700	631	10	8.98
800	721	20	17.98
900	811	30	26.8
1000	901	40	35.8
2000	1801	50	44.8
		60	53.8
		70	62.8
		80	71.8
		90	80.8
		100	89.8
		200	179.8
		300	268
		400	358
		500	448

Earth Tests (R_E)

Limit Value	Maximum Display Value	Limit Value	Maximum Display Value
10	8.8	200	179.8
20	17.8	300	268.0
30	26.8	400	358.0
40	35.8	500	448.0
50	44.8	600	538.0
60	53.8	700	628.0
70	62.8	800	718.0
80	71.8	900	808.0
90	80.8	1000	898.0
100	89.8	2000	1798.0

AC Voltage Measurement (V)

Range	Resolution	Accuracy 50 Hz – 60 Hz	Input Impedance	Overload Protection
500 V	0.1 V	0.8 % + 3	3.3 M Ω	660 V rms

Continuity Testing (R_{LO})

Range (Autoranging)	Resolution	Open Circuit Voltage	Accuracy
20 Ω	0.01 Ω	>4 V	$\pm(1.5 \% + 3 \text{ digits})$
200 Ω	0.1 Ω	>4 V	$\pm(1.5 \% + 3 \text{ digits})$
2000 Ω	1 Ω	>4 V	$\pm(1.5 \% + 3 \text{ digits})$
Note The number of possible continuity tests with a fresh set of batteries is 3000.			

Range R_{LO}	Test Current
7.5 Ω	210 mA
35 Ω	100 mA
240 Ω	20 mA
2000 Ω	2 mA

Test Probe Zeroing	Press the ZERO to zero the test probe. Can subtract up to 2 Ω of lead resistance. Error message for >2 Ω .
Live Circuit Detection	Inhibits test if terminal voltage >10 V ac detected prior to initiation of test.

Insulation Resistance Measurement (R_{ISO})

Test Voltages		Accuracy of Test Voltage (at rated test current)
Model 1652C	Model 1653B Model 1654B	
250-500-1000 V	50-100-250-500-1000 V	+10 %, -0 %

Test Voltage	Insulation Resistance Range	Resolution	Test Current	Accuracy
50 V	10 k Ω to 50 M Ω	0.01 M Ω	1 mA @ 50 k Ω	$\pm(3 \% + 3 \text{ digits})$
100 V	100 k Ω to 20 M Ω	0.01 M Ω	1 mA @ 100 k Ω	$\pm(3 \% + 3 \text{ digits})$
	20 M Ω to 100 M Ω	0.1 M Ω		$\pm(3 \% + 3 \text{ digits})$
250 V	10 k Ω to 20 M Ω	0.01 M Ω	1 mA @ 250 k Ω	$\pm(1.5 \% + 3 \text{ digits})$
	20 M Ω to 200 M Ω	0.1 M Ω		$\pm(1.5 \% + 3 \text{ digits})$
500 V	10 k Ω to 20 M Ω	0.01 M Ω	1 mA @ 500 k Ω	$\pm(1.5 \% + 3 \text{ digits})$
	20 M Ω to 200 M Ω	0.1 M Ω		$\pm(1.5 \% + 3 \text{ digits})$
	200 M Ω to 500 M Ω	1 M Ω		$\pm 10 \%$
1000 V	100 k Ω to 200 M Ω	0.1 M Ω	1 mA @ 1 M Ω	$\pm(1.5 \% + 3 \text{ digits})$
	200 M Ω to 1000 M Ω	1 M Ω		$\pm 10 \%$

Note

The number of possible insulation tests with a fresh set of batteries is 2000.

Auto Discharge	Discharge time constant <0.5 second for C = 1 μ F or less.
Live Circuit Detection	Inhibits test if terminal voltage >30 V prior to initiation of test.
Maximum Capacitive Load	Operable with up the 5 μ F load.

No Trip and Hi Current Modes RCD/FI

Mains Input Voltage Range	100 - 500 V ac (50/60 Hz)
Input Connection (soft key selection)	Loop Impedance: phase to earth Line impedance: phase to neutral
Limit on Consecutive Tests	Automatic shutdown when internal components are too hot. There is also a thermal shutdown for RCD tests.
Maximum Test Current @ 400 V	20 A sinusoidal for 10 ms
Maximum Test Current @ 230 V	12 A sinusoidal for 10 ms

Range	Resolution	Accuracy ^[1]
10 Ω	0.001 Ω	Hi Current mΩ mode: ±(2 % + 15 digits)
20 Ω	0.01 Ω	No Trip mode: ±(3 % + 6 digits)
		Hi Current mode: ±(2 % + 4 digits)
200 Ω	0.1 Ω	No Trip mode: ±(3 %)
		Hi Current mode: ±(2 %)
2000 Ω	1 Ω	±6 % ^[2]
Notes		
[1] Valid for resistance of neutral circuit <20 Ω and up to a system phase angle of 30 °. Test leads must be zeroed before testing.		
[2] Valid for mains voltage >200 V.		

Prospective Earth Fault Current Test (PSC/I_k)

Computation	Prospective Earth Fault Current (PEFC/I _k) or Prospective Short Circuit Current (PSC/I _k) determined by dividing measured mains voltage by measured loop (L-PE) resistance or line (L-N) resistance, respectively.	
Range	0 to 10 kA or 0 to 50 kA (See Power-On Options earlier in this manual)	
Resolution and Units	Resolution	Units
	I _k <1000 A	1 A
	I _k >1000 A	0.1 kA
Accuracy	Determined by accuracy of loop resistance and mains voltage measurements.	

RCD Testing

RCD Types Tested

RCD Type ^[6]		Model 1652C	Model 1653B	Model 1654B
AC ^[1]	G ^[2]	√	√	√
AC	S ^[3]	√	√	√
A ^[4]	G	√	√	√
A	S	√	√	√
B ^[5]	G			√
B	S			√
<p>Notes</p> <p>[1] AC – Responds to ac</p> <p>[2] G – General, no delay</p> <p>[3] S – Time delay</p> <p>[4] A – Responds to pulsed signal</p> <p>[5] B – Responds to smooth dc</p> <p>[6] RCD test inhibited for V >265 ac</p> <p style="text-align: center;">RCD tests permitted only if the selected current, multiplied by earthing resistance, is <50 V.</p>				

Test Signals

RCD Type	Test Signal Description
AC (sinusoidal)	The waveform is a sinewave starting at zero crossing, polarity determined by phase selection (0 ° phase starts with low to high zero crossing, 180 ° phase starts with high to low zero crossing). The magnitude of the test current is $I_{\Delta n} \times \text{Multiplier}$ for all tests.
A (half wave)	The waveform is a half wave rectified sinewave starting at zero, polarity determined by phase selection (0 ° phase starts with low to high zero crossing, 180 ° phase starts with high to low zero crossing). The magnitude of the test current is $2.0 \times I_{\Delta n} \text{ (rms)} \times \text{Multiplier}$ for all tests for $I_{\Delta n} = 0.01\text{A}$. The magnitude of the test current is $1.4 \times I_{\Delta n} \text{ (rms)} \times \text{Multiplier}$ for all tests for all other $I_{\Delta n}$ ratings.
B (DC)	This is a smooth DC current according to EN61557-6 Annex A

Tripping Speed Test (ΔT)

Test Function	RCD Current Selection						
	10 mA	30 mA	100 mA ^[1]	300 mA ^[1]	500 mA ^[1]	1000 mA ^[2]	var ^[3]
x ½, 1	√	√	√	√	√	√	√
x 5	√	√	√				
Ramp	√	√	√	√	√	√	√
Auto	√	√	√				

Notes
Mains voltage 100 V – 265 V ac, 50/60 Hz
[1] Type B RCDs require mains voltage range of 195 V – 265 V.
[2] Type AC RCDs only.
[3] Type A RCDs are limited to 700 mA, not available for Type B RCDs.

Current Multiplier	*RCD Type	Measurement Range		Trip Time Accuracy
		Europe	UK	
x ½	G	310 ms	2000 ms	±(1 % Reading + 1 ms)
x ½	S	510 ms	2000 ms	±(1 % Reading + 1 ms)
x 1	G	310 ms	310 ms	±(1 % Reading + 1 ms)
x 1	S	510 ms	510 ms	±(1 % Reading + 1 ms)
x 5	G	50 ms	50 ms	±(1 % Reading + 1 ms)
x 5	S	160 ms	160 ms	±(1 % Reading + 1 ms)

Notes
*G – General, no delay
*S – Time delay

Maximum Trip Time

The RCD ✓ symbol switches on when testing the RCD trip time if the trip time meets the following conditions:

RCD	I _{ΔN}	Trip Time Limits
AC G, A, B	x 1	Less than 300 ms
AC G-S, A-S, B-S	x 1	Between 130 ms and 500 ms
AC G, A, B	x 5	Less than 40 ms
AC G-S, A-S, B-S	x 5	Between 50 ms and 150 ms

RCD/FI-Tripping Current Measurement/Ramp Test ($I_{\Delta N}$)

Current Range	Step Size	Dwell Time		Measurement Accuracy
		Type G	Type S	
30 % to 110 % of RCD rated current ^[1]	10 % of $I_{\Delta N}$ ^[2]	300 ms/step	500 ms/step	±5 %
Notes [1] 30 % to 150 % for Type A $I_{\Delta N} > 10$ mA 30 % to 210 % for Type A $I_{\Delta N} = 10$ mA 20 % to 210 % for Type B Specified trip current ranges (EN 61008-1): 50 % to 100 % for Type AC 35 % to 140 % for Type A (>10 mA) 35 % to 200 % for Type A (≤10 mA) 50 % to 200 % for Type B [2] 5% for Type B				

Earth Resistance Test (R_E)

Models 1653B and 1654B Only. This product is intended to be used to measure installations in process plants, industrial installations, and residential applications.

Range	Resolution	Accuracy
200 Ω	0.1 Ω	±(2 % + 5 digits)
2000 Ω	1 Ω	±(3.5 % + 10 digits)

Range: $R_E + R_{PROBE}$ ^[1]	Test Current
2200 Ω	3.5 mA
16000 Ω	500 μA
52000 Ω	150 μA
Note [1] Without external voltages	



Frequency	Output Voltage
128 Hz	25 V

Live Circuit Detection	Inhibits test if terminal voltage >10 V ac is detected prior to start of test.
-------------------------------	--

Phase Sequence Indication

Icon	 icon Phase Sequence indicator is active.
Display of Phase Sequence	Displays "1-2-3" in digital display field for correct sequence. Displays "3-2-1" for incorrect phase. Dashes in place of a number indicate a valid determination could not be made.
Mains Input Voltage Range (phase-to-phase)	100 to 500 V

Mains Wiring Test

Icons (, , ) indicate if L-PE or L-N terminals are reversed. Instrument operation is inhibited and an error code is generated if the input voltage is not between 100 V and 500 V. The UK Loop and RCD tests are inhibited if the L-PE or the L-N terminals are reversed.

Operating Ranges and Uncertainties per EN 61557

Function	Display Range	EN 61557 Measurement Range Operating Uncertainty	Nominal Values
V EN 61557-1	0.0 V ac – 500 V ac	50 V ac – 500 V ac $\pm(2\% + 2 \text{ dgt})$	$U_N = 230/400 \text{ V ac}$ $f = 50/60 \text{ Hz}$
R _{LO} EN 61557-4	0.00 Ω - 2000 Ω	0.2 Ω - 2000 Ω $\pm(10\% + 2 \text{ dgt})$	4.0 V dc < U_Q < 24 V dc $R_{LO} \leq 2.00 \Omega$ $I_N \geq 200 \text{ mA}$
R _{ISO} EN 61557-2	0.00 M Ω - 1000 M Ω	1 M Ω - 200 M Ω $\pm(10\% + 2 \text{ dgt})$ 200 M Ω - 1000 M Ω $\pm(15\% + 2 \text{ dgt})$	$U_N = 50 / 100 / 250 / 500$ / 1000 V dc $I_N = 1.0 \text{ mA}$
Z _I EN 61557-3	Z _I (No Trip) 0.00 Ω - 2000 Ω	0.4 Ω - 2000 Ω $\pm(15\% + 6 \text{ dgt})$	$U_N = 230/400 \text{ V ac}$ $f = 50/60 \text{ Hz}$ $I_K = 0 \text{ A} - 10.0 \text{ kA}$
	Z _I (Hi Current) 0.00 Ω - 2000 Ω	0.2 Ω - 200 Ω $\pm(10\% + 4 \text{ dgt})$	
	Z _I (Hi Current, Hi Res) 0 m Ω - 9999 m Ω	100 m Ω - 9999 m Ω $\pm(8\% + 20 \text{ dgt})$	
	R _E 0.00 Ω - 2000 Ω	10 Ω - 1000 Ω $\pm(10\% + 2 \text{ dgt})$	
ΔT , I ΔN EN 61557-6	ΔT 0.0 ms – 2000 ms	25 ms – 2000 ms $\pm(10\% + 1 \text{ dgt})$	$\Delta T = 10 / 30 / 100 / 300 /$ 500 / 1000 / VAR mA
	I ΔN 3 mA – 550 mA (VAR 3 mA – 700 mA)	3 mA – 550 mA $\pm(10\% + 1 \text{ dgt})$	I $\Delta N = 10 / 30 / 100 / 300 /$ 500 / VAR mA
R _E EN 61557-5	0.0 Ω - 2000 Ω	10 Ω - 2000 Ω $\pm(10\% + 2 \text{ dgt})$	$f = 128 \text{ Hz}$
Phase EN 61557-7			1 : 2 : 3

Operating Uncertainties per EN 61557

The Operating Uncertainty shows the maximum possible uncertainty when all influence factors E1-E10 are counted.

	Volts	R_{Lo} EN 61557-4	R_{ISO} EN 61557-2	Z_I EN 61557-3	ΔT EN 61557-6	$I_{\Delta N}$ EN 61557-6	R_E EN 61557-5
Intrinsic Uncertainty A	0.80 %	1.50 %	10.00 %	6.00 %	1.00 %	5.00 %	3.50 %

Influence Quantity	Volts	R_{Lo} EN 61557-4	R_{ISO} EN 61557-2	Z_I EN 61557-3	ΔT EN 61557-6	$I_{\Delta N}$ EN 61557-6	R_E EN 61557-5
E1 - Position	0.00 %	0.00 %	0.00 %	0.00 %	0.00 %	0.00 %	0.00 %
E2 - Supply Voltage	0.50 %	3.00 %	3.00 %	3.00 %	3.00 %	2.75 %	2.25 %
E3 - Temperature	0.50 %	3.00 %	3.00 %	3.00 %	3.00 %	2.25 %	2.75 %
E4 - Series Interferences Voltage	-	-	-	-	-	-	1.50 %
E5 - Resistance of the probes and auxiliary earth electrodes	-	-	-	-	-	-	4.00 %
E6.2 - System phase angle	-	-	-	1.00 %	-	-	-
E7 - System frequency	0.50 %	-	-	2.50 %	-	-	0.00 %
E8 - System voltage	-	-	-	2.50 %	2.50 %	2.50 %	0.00 %
E9 - Harmonics	-	-	-	2.00 %	-	-	-
E10 - D.C. Quantity	-	-	-	2.50 %	-	-	-