

CONTACTOR, AC-3 30 KW/400 V, AC 110 V 50 HZ/ 120 V 60 HZ,  
3-POLE, SIZE S3, CAGE CLAMP



Figure similar

product brand name	SIRIUS
Product designation	power contactor
<b>General technical data:</b>	
Size of contactor	S3
Insulation voltage	
• rated value	1 000 V
Degree of pollution	3
Surge voltage resistance rated value	6 kV
maximum permissible voltage for safe isolation	
• between coil and main contacts acc. to EN 60947-1	690 V
Protection class IP	
• on the front	IP00
• of the terminal	IP00
Shock resistance	
• at rectangular impulse	
— at AC	6,8g / 5 ms, 4g / 10 ms
• with sine pulse	
— at AC	10,6g / 5 ms, 6,2g / 10 ms

<b>Mechanical service life (switching cycles)</b>	
<ul style="list-style-type: none"> <li>• of contactor typical</li> </ul>	10 000 000
<ul style="list-style-type: none"> <li>• of the contactor with added electronics-compatible auxiliary switch block typical</li> </ul>	5 000 000
<ul style="list-style-type: none"> <li>• of the contactor with added auxiliary switch block typical</li> </ul>	10 000 000

#### Ambient conditions:

<b>Installation altitude at height above sea level maximum</b>	2 000 m
<b>Ambient temperature</b>	
<ul style="list-style-type: none"> <li>• during operation</li> </ul>	-25 ... +60 °C
<ul style="list-style-type: none"> <li>• during storage</li> </ul>	-55 ... +80 °C

#### Main circuit:

<b>Number of NO contacts for main contacts</b>	3
<b>Number of NC contacts for main contacts</b>	0
<b>Operating current</b>	
<ul style="list-style-type: none"> <li>• at AC-1 at 400 V <ul style="list-style-type: none"> <li>— at ambient temperature 40 °C rated value</li> </ul> </li> </ul>	100 A
<ul style="list-style-type: none"> <li>• at AC-1 up to 690 V <ul style="list-style-type: none"> <li>— at ambient temperature 40 °C rated value</li> <li>— at ambient temperature 60 °C rated value</li> </ul> </li> </ul>	100 A 90 A
<ul style="list-style-type: none"> <li>• at AC-3 <ul style="list-style-type: none"> <li>— at 400 V rated value</li> <li>— at 690 V rated value</li> </ul> </li> </ul>	65 A 47 A
<b>Connectable conductor cross-section in main circuit at AC-1</b>	
<ul style="list-style-type: none"> <li>• at 60 °C minimum permissible</li> </ul>	35 mm <sup>2</sup>
<ul style="list-style-type: none"> <li>• at 40 °C minimum permissible</li> </ul>	35 mm <sup>2</sup>
<b>Operating current for approx. 200000 operating cycles at AC-4</b>	
<ul style="list-style-type: none"> <li>• at 400 V rated value</li> </ul>	28 A
<ul style="list-style-type: none"> <li>• at 690 V rated value</li> </ul>	20 A
<b>Operating current</b>	
<ul style="list-style-type: none"> <li>• at 1 current path at DC-1 <ul style="list-style-type: none"> <li>— at 24 V rated value</li> <li>— at 110 V rated value</li> </ul> </li> </ul>	90 A 4.5 A
<ul style="list-style-type: none"> <li>• with 2 current paths in series at DC-1 <ul style="list-style-type: none"> <li>— at 24 V rated value</li> <li>— at 110 V rated value</li> </ul> </li> </ul>	90 A 90 A
<ul style="list-style-type: none"> <li>• with 3 current paths in series at DC-1 <ul style="list-style-type: none"> <li>— at 24 V rated value</li> <li>— at 110 V rated value</li> </ul> </li> </ul>	90 A 90 A

<b>Operating current</b>	
<ul style="list-style-type: none"> <li>• at 1 current path at DC-3 at DC-5 <ul style="list-style-type: none"> <li>— at 24 V rated value</li> <li>— at 110 V rated value</li> </ul> </li> <li>• with 2 current paths in series at DC-3 at DC-5 <ul style="list-style-type: none"> <li>— at 110 V rated value</li> <li>— at 24 V rated value</li> </ul> </li> <li>• with 3 current paths in series at DC-3 at DC-5 <ul style="list-style-type: none"> <li>— at 110 V rated value</li> <li>— at 24 V rated value</li> </ul> </li> </ul>	<p>40 A</p> <p>2.5 A</p> <p>90 A</p> <p>90 A</p> <p>90 A</p> <p>90 A</p>
<b>Operating power</b>	
<ul style="list-style-type: none"> <li>• at AC-1 <ul style="list-style-type: none"> <li>— at 230 V at 60 °C rated value</li> <li>— at 400 V rated value</li> <li>— at 690 V rated value</li> <li>— at 690 V at 60 °C rated value</li> </ul> </li> <li>• at AC-2 at 400 V rated value</li> <li>• at AC-3 <ul style="list-style-type: none"> <li>— at 230 V rated value</li> <li>— at 400 V rated value</li> <li>— at 500 V rated value</li> <li>— at 690 V rated value</li> </ul> </li> </ul>	<p>34 kW</p> <p>59 kW</p> <p>102 kW</p> <p>102 kW</p> <p>30 kW</p> <p>18.5 kW</p> <p>30 kW</p> <p>37 kW</p> <p>45 kW</p>
<b>Operating power for approx. 200000 operating cycles at AC-4</b>	
<ul style="list-style-type: none"> <li>• at 400 V rated value</li> <li>• at 690 V rated value</li> </ul>	<p>15.1 kW</p> <p>18.6 kW</p>
<b>Thermal short-time current limited to 10 s</b>	
	600 A
<b>Power loss [W] at AC-3 at 400 V for rated value of the operating current per conductor</b>	
	4.6 W
<b>No-load switching frequency</b>	
<ul style="list-style-type: none"> <li>• at AC</li> </ul>	5 000 1/h
<b>Operating frequency</b>	
<ul style="list-style-type: none"> <li>• at AC-1 maximum</li> <li>• at AC-2 maximum</li> <li>• at AC-3 maximum</li> <li>• at AC-4 maximum</li> </ul>	<p>1 000 1/h</p> <p>400 1/h</p> <p>1 000 1/h</p> <p>300 1/h</p>
<b>Control circuit/ Control:</b>	
<b>Type of voltage of the control supply voltage</b>	
	AC
<b>Control supply voltage at AC</b>	
<ul style="list-style-type: none"> <li>• at 50 Hz rated value</li> <li>• at 60 Hz rated value</li> <li>• rated value</li> </ul>	<p>110 V</p> <p>120 V</p> <p>50 Hz</p>

<b>Control supply voltage frequency 2 rated value</b>	60 Hz
<b>Operating range factor control supply voltage rated value of magnet coil at AC</b>	
• at 50 Hz	0.8 ... 1.1
• at 60 Hz	0.8 ... 1.1
<b>Apparent pick-up power of magnet coil at AC</b>	232 V·A
<b>Inductive power factor with closing power of the coil</b>	0.55
<b>Apparent holding power of magnet coil at AC</b>	20 V·A
<b>Inductive power factor with the holding power of the coil</b>	0.28
<b>Closing delay</b>	
• at AC	16 ... 57 ms
<b>Opening delay</b>	
• at AC	10 ... 19 ms
<b>Arcing time</b>	10 ... 15 ms

#### Auxiliary circuit:

<b>Number of NC contacts</b>	
• for auxiliary contacts	
— instantaneous contact	0
<b>Number of NO contacts</b>	
• for auxiliary contacts	
— instantaneous contact	0
<b>Operating current at AC-12 maximum</b>	10 A
<b>Operating current at AC-15</b>	
• at 230 V rated value	6 A
• at 400 V rated value	3 A
<b>Operating current at DC-12</b>	
• at 60 V rated value	6 A
• at 110 V rated value	3 A
• at 220 V rated value	1 A
<b>Operating current at DC-13</b>	
• at 24 V rated value	10 A
• at 60 V rated value	2 A
• at 110 V rated value	1 A
• at 220 V rated value	0.3 A
<b>Contact reliability of auxiliary contacts</b>	1 faulty switching per 100 million (17 V, 1 mA)

#### UL/CSA ratings:

<b>Contact rating of auxiliary contacts according to UL</b>	A600 / Q600
---	-------------

#### Short-circuit protection

<b>Design of the fuse link</b>	
• for short-circuit protection of the main circuit	

- with type of coordination 1 required
- with type of assignment 2 required
- for short-circuit protection of the auxiliary switch required

fuse gL/gG: 250 A  
 fuse gL/gG: 125 A  
 fuse gL/gG: 10 A

#### Installation/ mounting/ dimensions:





<b>Mounting type</b>	screw and snap-on mounting onto 35 mm and 75 mm standard mounting rail
• Side-by-side mounting	Yes
<b>Height</b>	146 mm
<b>Width</b>	70 mm
<b>Depth</b>	139 mm
<b>Required spacing</b>	
• for grounded parts	
— at the side	6 mm

#### Connections/ Terminals:

<b>Type of electrical connection</b>	
• for main current circuit	screw-type terminals
• for auxiliary and control current circuit	spring-loaded terminals
<b>Type of connectable conductor cross-sections</b>	
• for main contacts	
— solid	2x (2.5 ... 16 mm <sup>2</sup> )
— stranded	2x (10 ... 50 mm <sup>2</sup> )
— single or multi-stranded	2x (2,5 ... 16 mm <sup>2</sup> )
— finely stranded with core end processing	2x (2.5 ... 35 mm <sup>2</sup> )
— finely stranded without core end processing	2x (10 ... 35 mm <sup>2</sup> )
• at AWG conductors for main contacts	2x (10 ... 1/0)
<b>Type of connectable conductor cross-sections</b>	
• for auxiliary contacts	
— solid	2x (0.25 ... 2.5 mm <sup>2</sup> )
— finely stranded with core end processing	2x (0.25 ... 1.5 mm <sup>2</sup> )
— finely stranded without core end processing	2x (0.25 ... 2.5 mm <sup>2</sup> )
• at AWG conductors for auxiliary contacts	2x (24 ... 14)

#### Certificates/approvals

General Product Approval				Declaration of Conformity	Test Certificates
 CCC	 CSA	 UL		 EG-Konf.	<a href="#">spezielle Prüfbescheinigungen</a>

Shipping Approval					other
 ABS	 GL	 LRS	 RINA	 RMRS	<a href="#">sonstig</a>

other
<a href="#">Umweltbestätigung</a> <a href="#">Bestätigungen</a>

### Further information

**Information- and Downloadcenter (Catalogs, Brochures,...)**

<http://www.siemens.com/industrial-controls/catalogs>

**Industry Mall (Online ordering system)**

<https://mall.industry.siemens.com/mall/en/en/Catalog/product?mlfb=3RT10443AK60>

**Cax online generator**

<http://support.automation.siemens.com/WW/CAXorder/default.aspx?lang=en&mlfb=3RT10443AK60>

**Service&Support (Manuals, Certificates, Characteristics, FAQs,...)**

<https://support.industry.siemens.com/cs/ww/en/ps/3RT10443AK60>

**Image database (product images, 2D dimension drawings, 3D models, device circuit diagrams, EPLAN macros, ...)**

[http://www.automation.siemens.com/bilddb/cax\\_de.aspx?mlfb=3RT10443AK60&lang=en](http://www.automation.siemens.com/bilddb/cax_de.aspx?mlfb=3RT10443AK60&lang=en)

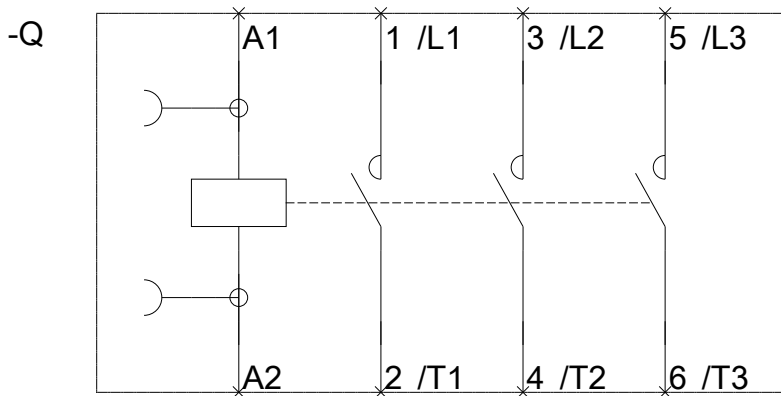
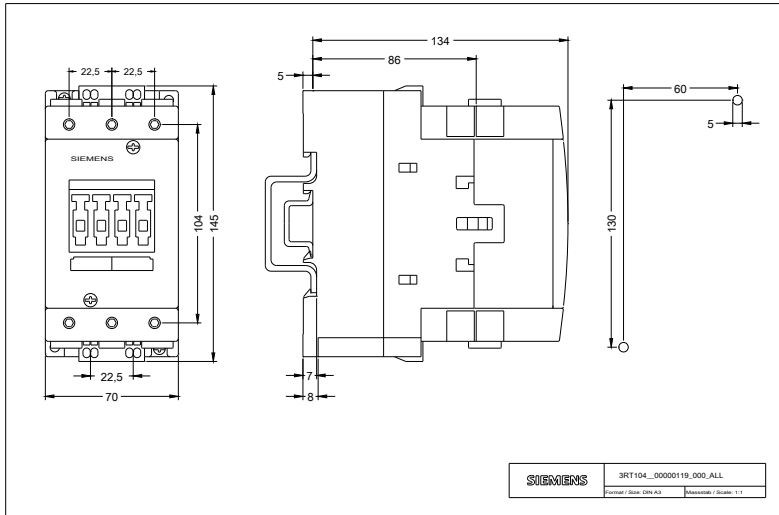

last modified:

14.04.2016