

# CPM-50 MULTIFUNCTION POWER Meter

## DESCRIPTION

The CPM series Multifunction Power Meter provide high accuracy measurement, display and communication(Modbus RTU) of all electrical and power quality parameters, including harmonic measurement up to 31<sup>st</sup> THD(Total Harmonic distortion) or Individual harmonic. They also have digital inputs and outputs and interface with versatile functions such as remote control, alarm, statistics and records.



CPM-50

## APPLICATIONS

Control panels and Motor, Generator monitoring  
Switchgear distribution systems  
Energy Management  
Power quality analysis

## ORDERING INFORMATION

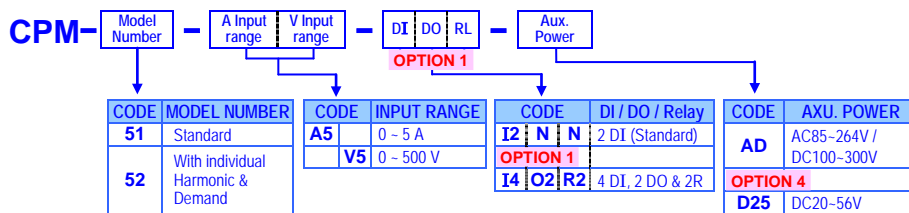

## TECHNICAL SPECIFICATION

PARAMETERS		CPM-51	CPM-52	
Power Measurements	Voltage	V <sub>12</sub> V <sub>23</sub> V <sub>31</sub> V <sub>LL</sub> Avg V <sub>1</sub> V <sub>2</sub> V <sub>3</sub> V <sub>LN</sub> Avg	●	●
	Current	I <sub>1</sub> I <sub>2</sub> I <sub>3</sub> I <sub>Avg</sub> I <sub>N</sub>	●	●
	Active Power	P <sub>1</sub> P <sub>2</sub> P <sub>3</sub> ΣP	●	●
	Reactive Power	Q <sub>1</sub> Q <sub>2</sub> Q <sub>3</sub> ΣQ	●	●
	Apparent Power	S <sub>1</sub> S <sub>2</sub> S <sub>3</sub> ΣS	●	●
	Power Factor	PF <sub>1</sub> PF <sub>2</sub> PF <sub>3</sub> PF <sub>Avg</sub>	●	●
	Frequency	Hz	●	●
	Active Energy	WH <sub>Imp</sub> WH <sub>Exp</sub> WH <sub>Total</sub> WH <sub>Net</sub>	●	●
	Reactive Energy	QH <sub>Imp</sub> QH <sub>Exp</sub> QH <sub>Total</sub> QH <sub>Net</sub>	●	●
	Demand	Pmd Omd Smd		●
Power Quality	Un-balance	V <sub>unbl</sub> I <sub>unbl</sub>	●	●
	THD for Voltage	THD <sub>V12</sub> THD <sub>V23</sub> THD <sub>V31</sub> THD <sub>V</sub> Avg	●	●
	THD for Current	THD <sub>I1</sub> THD <sub>I2</sub> THD <sub>I3</sub> THD <sub>I</sub> Avg	●	●
	Individual Harmonic	2 <sup>nd</sup> -31 <sup>st</sup>		●
	Crest Factor for Volt	Crest Factor		●
I/O	K Factor for Current	K Factor		●
	Max/Mini Recording	Maxi. & Mini. Recording for all parameters with time stamp		●
I/O	Digital Input	DI <sub>1</sub> DI <sub>2</sub> *DI <sub>3</sub> *DI <sub>4</sub>	●	●
	Digital Output	*DO <sub>1</sub> *DO <sub>2</sub>	Pulse	Pulse
	Relay Output	*RO <sub>1</sub> *RO <sub>2</sub> (to be Alarm or DO)	●	●
	RS485 Port	Modbus RTU mode	●	●
	Real Time Clock	Year, Month, Day, Hour, Minute, Sec.	●	●

\* means optional, please specify in ordering information.

### Accuracy & Resolutions

PARAMETERS	ACCURACY	RESOLUTION	INPUT RANGE
Voltage	0.2%	0.1%	40-290Vac(V <sub>L-N</sub> )
Current	0.2%	0.02%	1%-120% of Rated I
Neutral Current	1.0%	0.1%	1%-120% of Rated I
Active Power	0.5%	0.1%	0-9999MW
Reactive Power	0.5%	0.1%	0-9999Mvar
Apparent Power	0.5%	0.1%	0-9999MVA
Power Factor	0.5%	0.1%	±0.02-1.00
Frequency	0.2%	0.01Hz	45-65Hz
Active Energy	1.0%	0.1KWh	0-99999999.9KWh
Reactive Energy	2.0%	0.1KVarh	0-99999999.9KVarh
THD	1.0%	0.01%	0-100%
Individual Harmonic	1.0%	0.01%	0-100%
Un-balance	0.5%	0.1%	0-300%

### Input

**Measurement:** True rms measurement  
**Sampling:** 128point/Cycle  
**Connection:** 1P2W, 1P3W, 3P3W, 3P4W, Balance/Unbalance; According to the elements of PT and CT, it will be programmed by front keys.  
**Input Range:** Voltage: 40-290V L-N / 70-500V L-L  
 PT ratio(primary) programmable: 100-500000V  
 PT ratio(secondary) programmable: 100-400V  
 Current: 5A, 1A(Optional)  
 CT ratio(primary) programmable: 5(1)-10000A  
 Frequency: 45-65Hz

### Max. Input over capability:

**Voltage:** 2 x rated continuous; 2500V for 1 second  
**Current:** 2 x rated continuous; 20 x rated for 1 second  
**Input Burden:** Voltage: < 0.2VA, Current: < 0.1VA

### I/O functions

The meter offers two digital inputs as standard. Additionally, there is an I/O module available as option. The module offers an extra two digital inputs, two digital outputs, two relay outputs, and a DC aux power (for DI). Please specify the option code in ordering, if that extra I/O is to be request.

### Digital input(DI):

standard: 2 points (4 points in optional);  
 Photo couple, 5-30V, 20mA maximum  
 Response time ≤ 300ms

Isolation: 2500Vac

### Functions:

### Digital output(DO):

2 points; Photo-MOS, 100Vdc, 50mA (optional)  
 Response time ≤ 300ms  
 Isolation: 2500Vac

### Functions:

#### Energy Mode:

There are two mode can be programmed as below:  
 Pulse output represents Energy. Each output can be user programmed to represent Imp/Exp/Total/Net KWh or Imp/Exp/Total/Net KVarh

**Pulse rate divider:** programmable 1-6000(x0.1) KWh(KVarh)/p

**Pulse width:** programmable 1-50(x 20msec)

### Relay output:

#### Functions:

2 relay, FORM-A, 3A/250Vac, 3A/30Vdc (Optional)  
 Output as Hi or Low Alarm. Each output can be user programmed for 9 parameters of any 34 measured values.

On triggering an alarm there will be an output plus record In EEPROM with time stamp. The alarm mode is set up by RS485, please refer to operating manual.

**Normal:** Relay energized can be set to be two type in Normal energized and momentary energized the relay will be energized when the measured meets condition of set.

**momentary:** Relay energized for a period(Ton) and than goes off, when the measured meets condition of set..

**Energized level:** programmable High or Low  
**T on time(momentary type):** programmable from 50-3000ms

**Back light on for Alarm:** An Alarm can turn the back-light will be turned on... The on time can be set from 0-120 minutes(0= turn on and continuous).

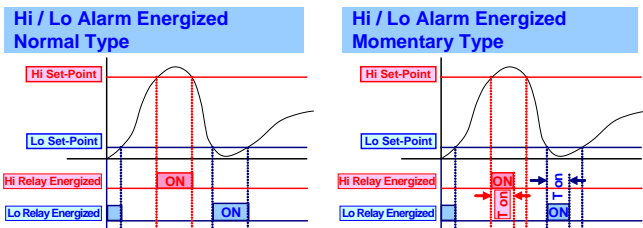

**Remote Control:** Allows a remote computer to directly control the outputs.

**Power Quality**

The instrument gives an evaluation of energy quality by Total Harmonic Distortion, individual Harmonic, Crest Factor of voltage, K Factor of Current, Max/Min stamp, un-balance.

**Harmonic:** 2<sup>nd</sup>-31<sup>st</sup> individual harmonic for Voltage and Current  
**THD:** 2<sup>nd</sup>-31<sup>st</sup> Total harmonic distortion for Voltage and Current

**K Factor for Current:** K-factor is a weighting of the harmonic load currents According to their effects on transformer heating. A K-factor of 1.0 indicates a linear load (no harmonics). The higher the K-factor, the greater the harmonic Heating effects

**Crest Factor:** The purpose of it calculation is to give an analyst a quick idea of how much impacting is occurring in a waveform.

**Max/Mini stamp:** Custom alarm with time stamping  
**Recording measurements:** V<sub>LN</sub>, V<sub>LL</sub>, I<sub>L</sub>, ΣP, ΣQ, ΣS, THD, Un-balance, Hz, PF, Demand

**Recording period:** Month, Day,  
**Un-balance:** Shows Un-balance for Voltage and Current

**Demand** For Active, Re-active, Apparent power. They can be calculated in present and maximum value.

**Demand calculation:** sliding window, one Minute each time  
**Calculation period:** programmable from 1-30 minutes

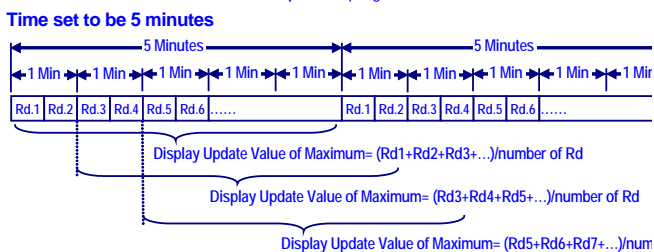

**Remark: Sliding Period: 1 time/1 minute**

**RS485 communication (standard)**

**Protocol:** Modbus RTU mode  
**Baud rate:** 600/1200/2400/4800/9600/19200/38400  
**Data bits:** 8 bits  
**Parity:** None  
**Stop bits:** 1  
**Address:** 1-247  
**Wiring:** 1200M max,  
**Termination Res.:** 120-300Ω/0.25W(typical: 150Ω)

**Electrical safety**

**Dielectric Strength:** AC 2KV, 50/60Hz, 1 min. Between Input / Output / Power / Case  
**Surge test:** 3KV, 1.2 x 50 μsec. Common mode & differential mode  
**Insulation Res.:** ≥100M ohm, DC 500V  
**Isolation:** Input / Output / Power / Case  
**EMC:** EN 55011:2002; EN 61326:2003  
**Safety(LVD):** EN 61010-1:2001

**Environmental**

**Operating Temp.:** -10-70 °C  
**Operating Humidity:** 5-95 %RH, Non-condensing  
**Temp. Coefficient:** ≤100 PPM/°C  
**Storage Temperature:** -40-85 °C  
**Enclosure:** Front panel: IEC 529 (IP52); Housing: IP30

**Power**

**Power supply:** AC 85-264 / DC 100-300V, optional: DC 20-56V (Auxiliary Power needs to be grounded; effectively reduce electromagnetic)  
**Power effect:** ≤ 0.05% F.S.  
**Power consumption:** ≤ 3W @ 230Vac  
**Back up memory:** By EEPROM

**Mechanical**

**Dimension:** 96mm(W) x 96mm(H) x 71mm(D)(79mm with I/O module)  
**Panel cutout:** 90mm(W) x 90mm(H)  
**Case material:** White ABS  
**Mounting:** Panel flush mounting  
**Connection:** Screw terminal, Plastic NYLON 66 (UL 94V-0)  
 Current/Voltage input(#1-#10): 1.5-2.5mm<sup>2</sup>(AWG 15-10)  
 Other: 0.5-1.3mm<sup>2</sup>(AWG 22-16)  
**Weight:** Under 400g

**FRONT PANEL**

**Display:** LCD 65x58mm white back light visible under sunshine  
 LCD protection function: the period time of back light on can be set from 0-120 minutes

**Reading:** 8888 4 digital x 4 line, 10.0mm high for V, A, Power, Hz, PF, THD, Demand, Unbalance, Max/Mini...  
 8888888888 1 line 9 digital, 6.0mm high for Energy, Clock and Date

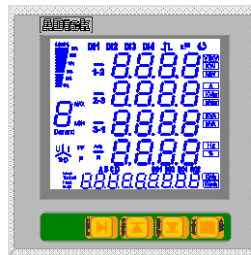

**I/O Status:**

**DIx** Digital Input blight when the DI energized  
**DOx** Digital Output blight when the DO energized  
**ROx** Relay Output blight when the RL energized  
**⏏** Flash when Pulse output  
**■** Flash when RS485 communication. There are two squares that one is for master, another one is for slave. It will be checked easier which side is getting trouble.

**Load status indication:**

**|||||** Blight to show percentage of Current rated  
**⚡** Blight when the load is Inductive  
**⚡** Blight when the load is Capacitive  
**⏏** Blight to show percentage of the un-balanced of V and I

**Reading variety symbols:**

**1-2 2-3 3-1** Blight means that values are showing value in Line-Line  
**1 2 3** Blight means that values are showing value in Phase  
**N** Blight means that values are showing value of the I<sub>N</sub>  
**Imp Exp Total Net** Energy direction or mathematic  
**Avg** Blight means that values are showing value of average for parameters

**MAX MIN** Blight means that values are showing maximum or minimum value storage during power on of the meter.

**Demand** Blight means that values are showing demand for Powers

**THD** Blight means that values are showing value of THD

**Remark:** The individual harmonics reading and Event record have to read by RS485 of master.

**V** **kV** **A** **kW** **Mvar**.. Engineer units for parameters

**Display Update:** 0.5 second

**Operating Key:** A 4-button interface for on front panel

- Shift Key / Quick View for Harmonics pages
  - Up Key / Quick View for Power pages
  - Down Key / Quick View for Energy pages
  - Enter Key / Quick View for Voltage & Current Pages
- 4 digits Password, settable from 0000-9999

**Security Code:**

## DIMENSIONS

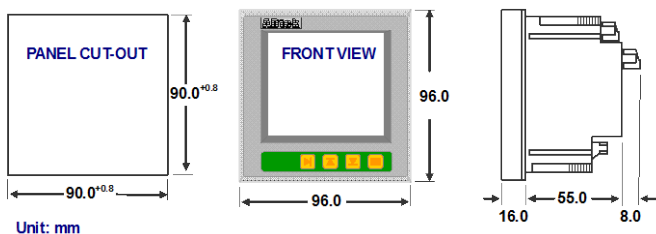

## PANEL MOUNTING HOLES

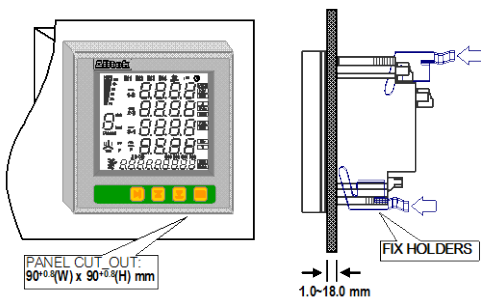

## CONNECTION DIAGRAM

### Auxiliary Power (Terminal Block 2)

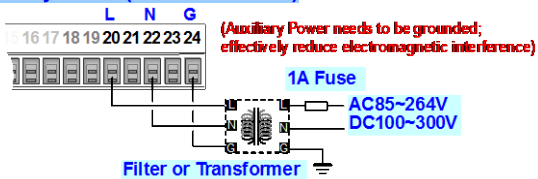

### Voltage & Current Input (Terminal Block 1)

The connection has to relative the page 3 and page 4 of programming.

Voltage wiring: AWG16~12(1.3~2.0mm<sup>2</sup>)

Current wiring: AWG15~10(1.5~2.5mm<sup>2</sup>)

### 3 Phase 4 Wire with 3PT/3CT [ Setting: 3LN, 3CT ]

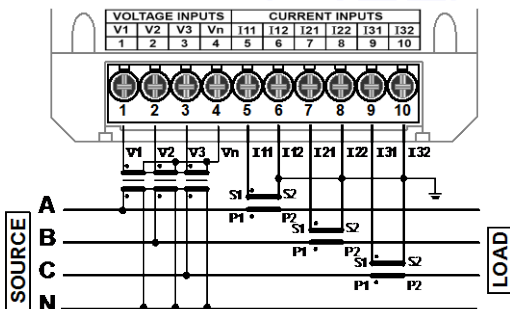

### 3 Phase 4 wire – direct/3CT [ Setting: 3LN, 3CT ]

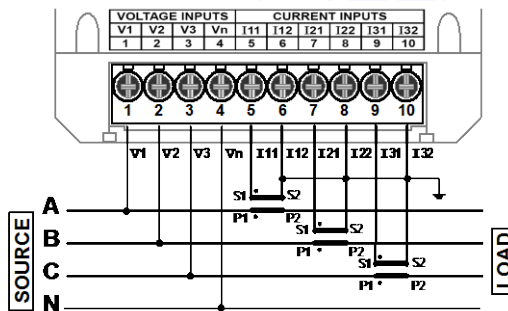

### 3 Phase 4 wire – direct/2CT [ Setting: 3LN, 3CT ]

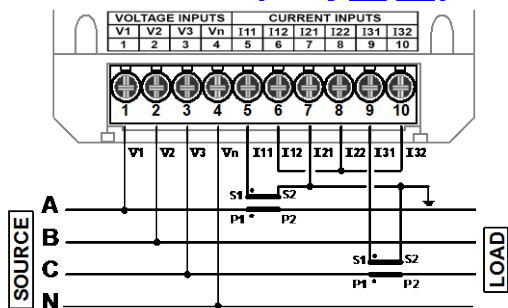

### 3 Phase 4 wire(Balanced) with 2PT/1CT [ Setting: 2LN, 1CT ]

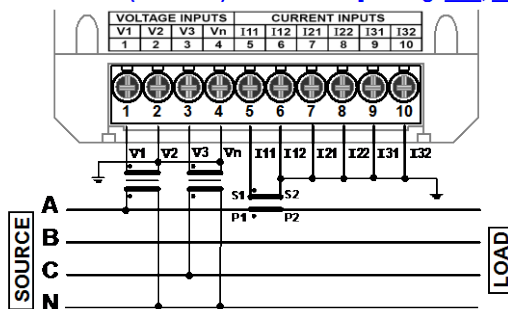

### 3 Phase 3 wire with 2PT/2CT [ Setting: 2LL, 2CT ]

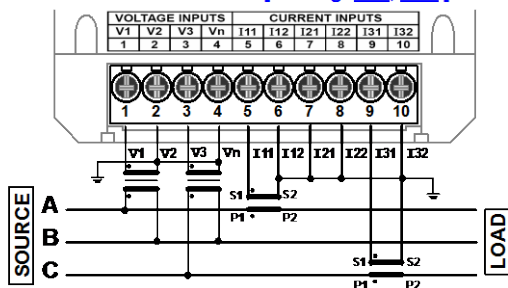

### 3 Phase 3 wire - direct / 2CT [ Setting: 2LL, 2CT ]

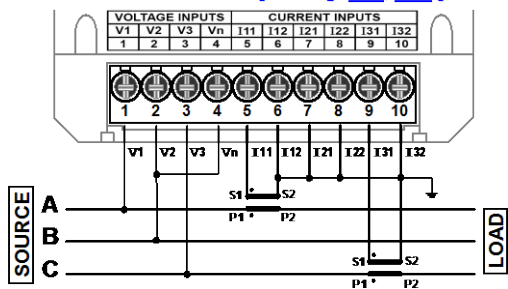

3 Phase 3 wire (Balanced) with 2PT/1CT [ Setting: 2LL, 1CT ]

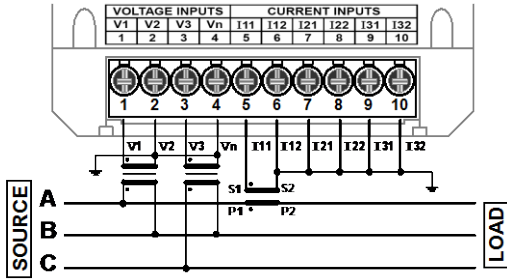

3 Phase 3 wire (Balanced) – direct / 1CT [ Setting: 2LL, 1CT ]

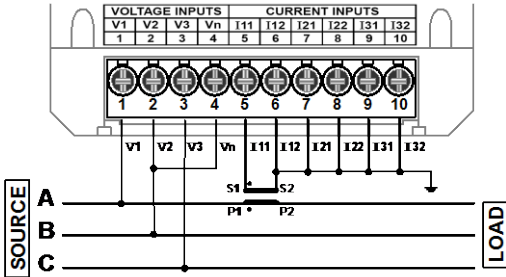

1 Phase 3 wire – [ Setting 3LN, 3CT ]

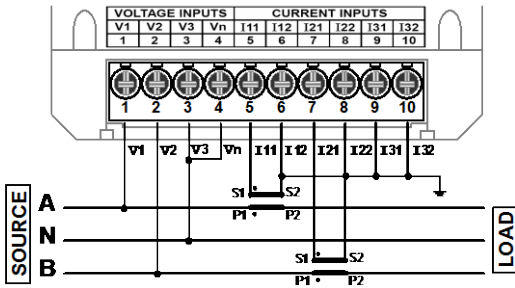

1 Phase 2 wire – [ Setting 3LN, 3CT ]

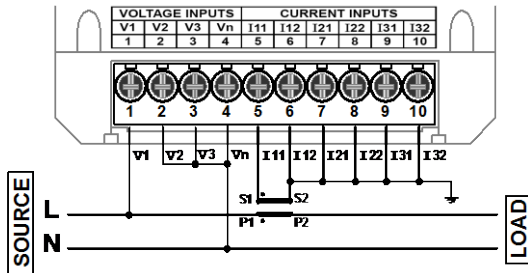

RS485 / 2DI (Terminal Block 2) and Extra 2DI / 2DO / 2Relay (Optional I/O Module) Wiring: AWG22-16(0.5-1.3mm<sup>2</sup>)

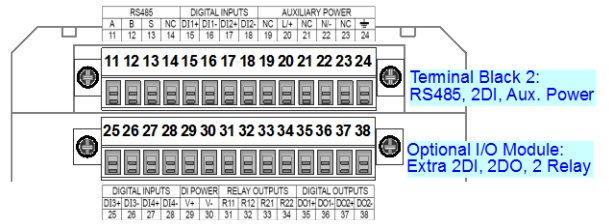

2DI(Standard) with external DC powered

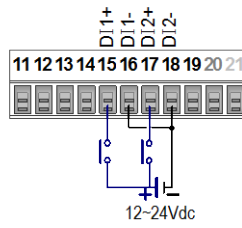

4DI(Optional) with internal DC powered

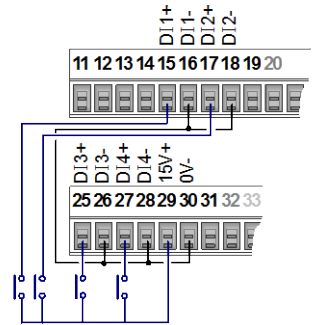

2 Relay(Optional) with External Power Relay

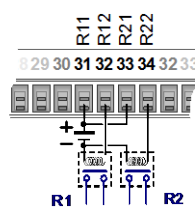

2 DO(Optional) with External Powered

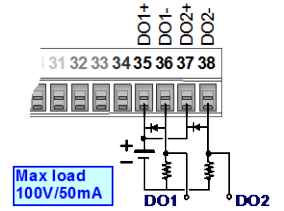

Max load 100V/50mA

RS485 Communication Port

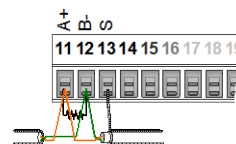

Max. Distance: 1200M  
Terminate Resistor (at latest unit):  
120-300ohm/0.25W(typical: 150ohm)

Amend  
2009/11/8: add 3P3W / 3P3W balanced connection without PT connection diagram  
2010/9/01 add 3P4W 3 Phase 4 wire – direct/2CT connection diagram