

ST-VA(v1.0) VOLT/CURRENT CONDITIONER ST-PR(v1.0) PROCESS(DC) CONDITIONER ST-SG(v1.0) STRAIN GAUGE CONDITIONER ST-PM(v1.0) POTENTIOMETER CONDITIONER ST-RS(v1.0) RESISTANCE CONDITIONER ST-T(v1.0) TEMPERATURE CONDITIONER **OPERATION MANUAL**

FEATURES

[ST-VA]

➤ Measuring Voltage 0~600V or Current 0~5A for DC / AC / TRMS

➤ Accuracy: ± 0.04% or ± 0.1%; Display range: -19999~29999

[ST-PR]

➤ Measuring Voltage 0~10Vdc & Current 0(4)~20mAdc

➤ Accuracy: ± 0.04%; Display range: -19999~29999

[ST-SG]

➤ Measuring Strain Gauge 0~1.0/~2.0/~4.0/...../~10.0/20.0/~40.0mV/V

➤ *Field calibration with strain gauge to meet the system requirement*

[ST-PM]

➤ Measuring Potentiometer 0~100Ω/~2KΩ; 0~100Ω~100 KΩ(3 wire)

➤ *Field calibration with strain gauge to meet the system requirement*

[ST-RS]

➤ Measuring Resistance 0~200Ω/~2000Ω/~20.00KΩ/~200.0KΩ(2 wire)

➤ *Field calibration with Resistance to meet the system requirement*

[ST-TR(C)]

➤ Measuring Rtd: Pt100Ω / Thermocouple: K, J, E, T, R, S, B

FUNCTIONS

- User function, easily programmable via the top panel
- *Analogue output, RS 485 communication port and 1 Relay output available*
- Analogue output can be selected in 0~10V/0(4)~20mA
- *Relay output for Hi / Lo energized with Start Delay / Hysteresis / Energized & De-energized Delay / Relay Energized Hold..... functions*
- RS 485 communication port available



FUNCTIONS

DISPLAY FUNCTIONS

Maximum Hold or Minimum Hold:

The converter will keep display in maximum value during power on until manual reset by front key in [User Level]

Write to display by RS485 command

The display can be written by RS485 command. In past, The converter normally receive 4~20mA or 0~10V from AO card or BCD card of PLC. We support a new solution by RS485 writing in so that can be **save cost and wiring** into PLC.

Low Cut / Digital Filter / Digital Fine Adjustment

- **Low Cut:** setting range from -5000~+5000 counts.
 - If the setting value is positive, it means the range of absolute value will be 0; $PV \leq$ Setting value, the display will be 0;
 - EX :** Low Cut is set for 0.10, if the display is from -0.10~+0.10, that will be 0.
 - If the setting value is negative, it means the range of under setting value will be 0; $PV \leq$ -Setting value, the display will be 0;

EX : Low Cut is set for -0.01, if the display is \leq -0.01, and all the display will be 0.

- **Digital filter:** setting range from 0(None)/1~99 times. The digital filter can reduce the magnetic noise in field.
- **Digital Fine Adjustment:** setting range from -19999~+29999; Users can get Fine Adjustment by front key of the converter, and "Just Key In" the value which user want to show in the current input signals.

RELAY FUNCTIONS

- **Start Delay**
- **Hysteresis:** Settable range from 0~9999 Counts
- **Relay energized delay:** Settable range from 0.1(second)~9(minutes)59.9(seconds);
- **Relay de-energized delay:** Settable range from 0.1(second)~9(minutes)59.9(seconds)
- **Relay energized mode Hi / Lo / Hi.HLd / Lo.HLd / DO**
 - **Hi:** Relay will energize when $PV >$ Set-Point
 - **Lo:** Relay will energize when $PV <$ Set-Point
 - **Hi.HLd (Lo.HLd):** When the PV Higher (or lower) than set-point, the relay will be energized and hold until manual reset by from key in [User Level] .

ANALOGUE OUTPUT FUNCTIONS

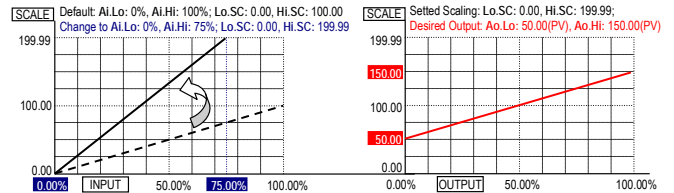

- **DO:** Relay is energized by RS485 command directly, and no longer to compare with set-point of relay

FIELD CALIBRATION(This function is for ST-SG, ST-PM & ST-RS)

- In pass time, engineers have take a lot of time to adjust meters or converter to meet the structure of machinery zero and span for the Load Cell and Potentiometer measuring. Now, our ST-LC support easlier process to do it called **“Field Calibration”**.
- Field calibration can be done individual in input 1 and input 2.
- Adjust the structure of machinery to be **“zero status”**.
- Enter the right pass code of the meter to get into the **Field Calibration Level**.
- Move page to the **CAL1.L**, and press **ENT** Key to stand by. Press **ENT** Key again to read the signal low of sensing device. After it done, the page will change to **CAL1.H** automatically. The low point will be the new zero.
- Adjust the structure of machinery to be **“span status”**.
- In **CAL1.H** page, press **ENT** Key to stand by. Press **ENT** Key again to read the signal high of sensing device. After it done, the page will change to **C.SEL1** automatically. The high point will be the new span.
 - Reading the signal will take few seconds.
 - Please check the setting of high scale **Hi.SC** and low scale **Lo.SC** again, after the “Field Calibration” has done.
- **C.SEL1**(Calibration parameter selection): Field calibration don't change the default calibration. So, after you do field calibration, you can select default calibration if you want.

Potentiometer 0~1.0K?

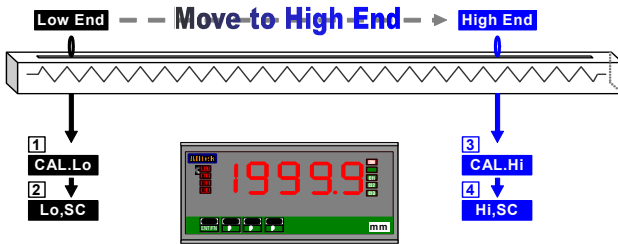

APPLICATIONS

- Switch Boards
- Motor Control Boards
- Display Voltage or Amp for Mechanical Equipment
- Testing Instruments

ST-SERIES APPLICATION FOR VOLTAGE / CURRENT & FREQUENCY MEASURING

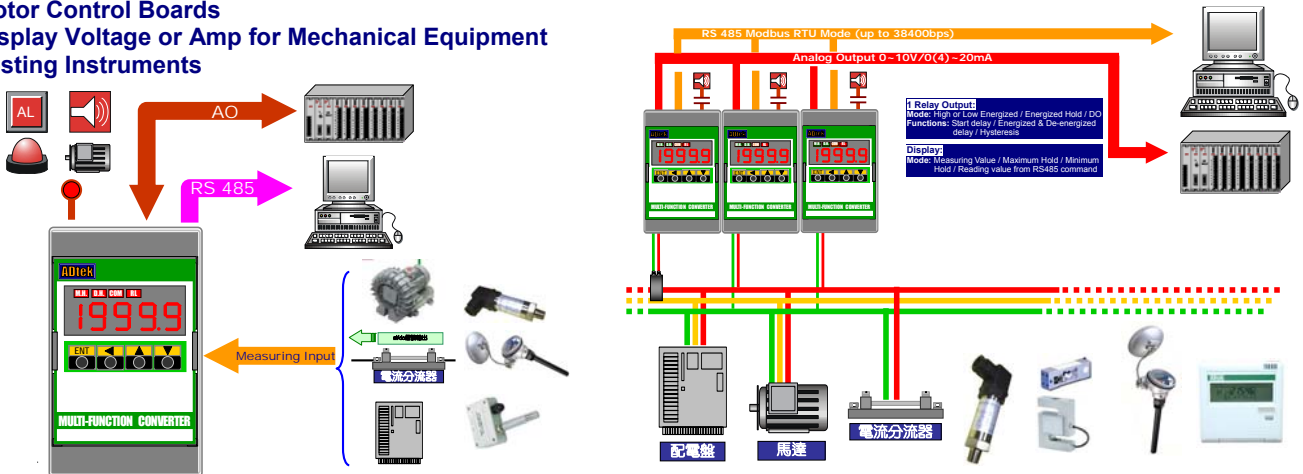

FRONT PANEL

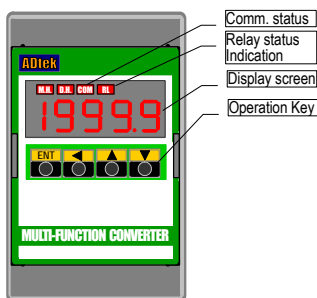

INSTALLATION

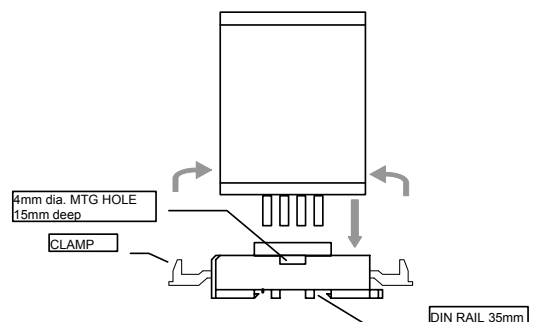

DIMENSIONS

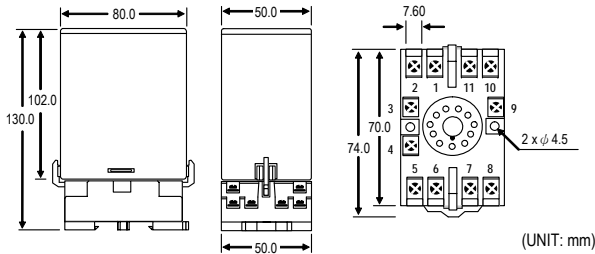

WIRING DIAGRAM

[ST-VA 600V or 5A]

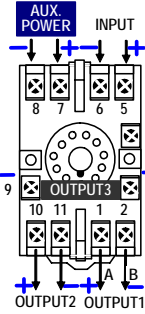

Remark: ST series has been designed in multi-output with limited terminals. Please check the output functions and specify terminals as label on product before wiring.

	OUTPUT 1 TERMINAL 1+ & 2-	OUTPUT 2 TERMINAL 10+ & 11-	OUTPUT 3 TERMINAL 3+ & 9-
3 O/P	RS485	ANALOGUE	RELAY
3 O/P	ANALOGUE	RELAY	RELAY
3 O/P	RS485	RELAY	RELAY
3 O/P	RELAY	RELAY	RELAY
2 O/P	RS485	ANALOGUE	
2 O/P	RS485	RELAY	
2 O/P	ANALOGUE	RELAY	
1 O/P	ANALOGUE		
1 O/P	RS485		
1 O/P	RELAY		

DO NOT UNPLUG IF LIVE

[ST-PR DC SIGNAL]

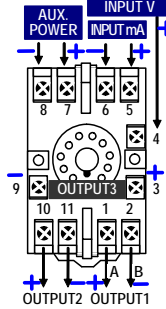

20mA INPUT 10V INPUT
TERMINAL 5+ & 6- TERMINAL 4+ & 6-

Remark: ST series has been designed in multi-output with limited terminals. Please check the output functions and specify terminals as label on product before wiring.

	OUTPUT 1 TERMINAL 1+ & 2-	OUTPUT 2 TERMINAL 10+ & 11-	OUTPUT 3 TERMINAL 3+ & 9-
3 O/P	RS485	ANALOGUE	EXCITATION SUPPLY
3 O/P	ANALOGUE	RELAY	EXCITATION SUPPLY
3 O/P	RS485	RELAY	EXCITATION SUPPLY
3 O/P	RELAY	RELAY	EXCITATION SUPPLY
3 O/P	RS485	ANALOGUE	RELAY
3 O/P	ANALOGUE	RELAY	RELAY
3 O/P	RS485	RELAY	RELAY
3 O/P	RELAY	RELAY	RELAY
2 O/P	ANALOGUE		EXCITATION SUPPLY
2 O/P	RS485		EXCITATION SUPPLY
2 O/P	RELAY		EXCITATION SUPPLY
2 O/P	RS485	ANALOGUE	
2 O/P	RS485	RELAY	
2 O/P	ANALOGUE	RELAY	
1 O/P	ANALOGUE		
1 O/P	RS485		
1 O/P	RELAY		

[ST-SG STRAIN GAUGE / LOAD CELL]

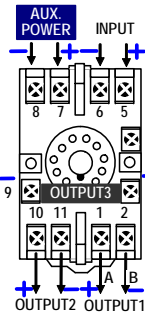

Remark: ST series has been designed in multi-output with limited terminals. Please check the output functions and specify terminals as label on product before wiring.

	OUTPUT 1 TERMINAL 1+ & 2-	OUTPUT 2 TERMINAL 10+ & 11-	OUTPUT 3 TERMINAL 3+ & 9-
3 O/P	RS485	ANALOGUE	EXCITATION
3 O/P	ANALOGUE	RELAY	EXCITATION
3 O/P	RS485	RELAY	EXCITATION
3 O/P	RELAY	RELAY	EXCITATION
3 O/P	RS485	ANALOGUE	RELAY
3 O/P	ANALOGUE	RELAY	RELAY
3 O/P	RS485	RELAY	RELAY
3 O/P	RELAY	RELAY	RELAY
2 O/P	ANALOGUE		EXCITATION
2 O/P	RS485		EXCITATION
2 O/P	RELAY		EXCITATION
2 O/P	ANALOGUE	RELAY	
2 O/P	RS485	RELAY	
2 O/P	ANALOGUE	RELAY	
2 O/P	RS485	ANALOGUE	
2 O/P	RS485	ANALOGUE	

[ST-PM POTENTIOMETER]

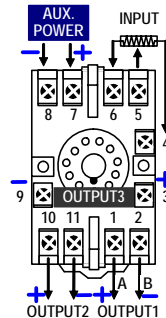

Remark: ST series has been designed in multi-output with limited terminals. Please check the output functions and specify terminals as label on product before wiring.

	OUTPUT 1 TERMINAL 1+ & 2-	OUTPUT 2 TERMINAL 11+ & 10-	OUTPUT 3 TERMINAL 3+ & 9-
3 O/P	RS485	ANALOGUE	RELAY
3 O/P	ANALOGUE	RELAY	RELAY
3 O/P	RS485	RELAY	RELAY
3 O/P	RELAY	RELAY	RELAY
2 O/P	RS485	ANALOGUE	
2 O/P	RS485	RELAY	
2 O/P	ANALOGUE	RELAY	
1 O/P	ANALOGUE		
1 O/P	RS485		
1 O/P	RELAY		

[ST-RS RESISTANCE]

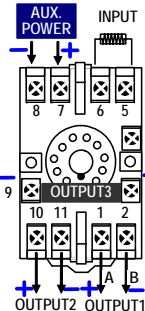

Remark: ST series has been designed in multi-output with limited terminals. Please check the output functions and specify terminals as label on product before wiring.

	OUTPUT 1 TERMINAL 1+ & 2-	OUTPUT 2 TERMINAL 10+ & 11-	OUTPUT 3 TERMINAL 3+ & 9-
3 O/P	RS485	ANALOGUE	RELAY
3 O/P	ANALOGUE	RELAY	RELAY
3 O/P	RS485	RELAY	RELAY
3 O/P	RELAY	RELAY	RELAY
2 O/P	RS485	ANALOGUE	
2 O/P	RS485	RELAY	
2 O/P	ANALOGUE	RELAY	
1 O/P	ANALOGUE		
1 O/P	RS485		
1 O/P	RELAY		

[ST-TR(C) TEMPERATURE PT100Ω or THERMOCOUPLE]

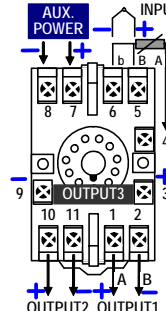

Remark: ST series has been designed in multi-output with limited terminals. Please check the output functions and specify terminals as label on product before wiring.

	OUTPUT 1 TERMINAL 1+ & 2-	OUTPUT 2 TERMINAL 10+ & 11-	OUTPUT 3 TERMINAL 3+ & 9-
3 O/P	RS485	ANALOGUE	RELAY
3 O/P	ANALOGUE	RELAY	RELAY
3 O/P	RS485	RELAY	RELAY
3 O/P	RELAY	RELAY	RELAY
2 O/P	RS485	ANALOGUE	
2 O/P	RS485	RELAY	
2 O/P	ANALOGUE	RELAY	
1 O/P	ANALOGUE		
1 O/P	RS485		
1 O/P	RELAY		

Amend: 2010/4/28: Change power supply code from D25 to ADL: AC/DC20-56V, ADH:AC/DC85-264V

ORDER INFORMATION

ORDERING INFORMATION

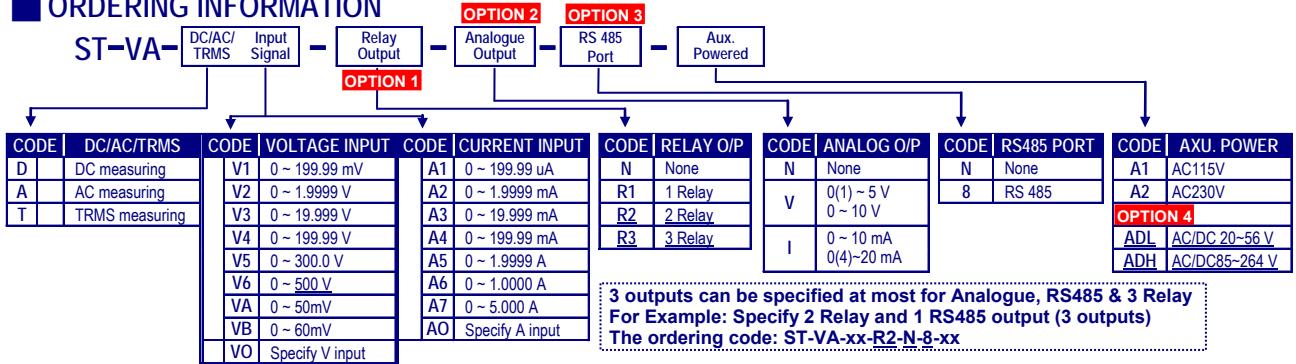

ORDERING INFORMATION

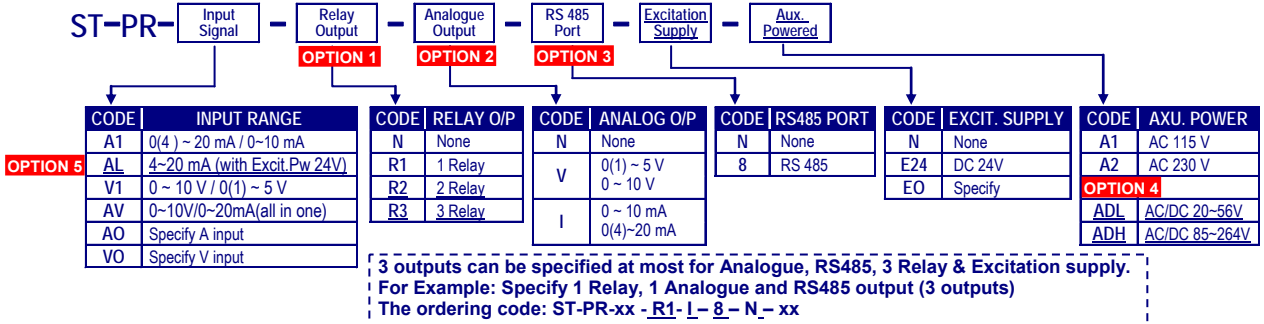

ORDERING INFORMATION

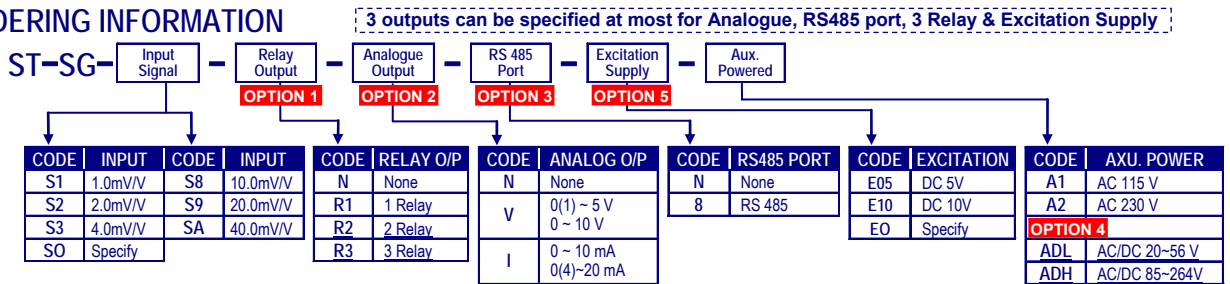

ORDERING INFORMATION

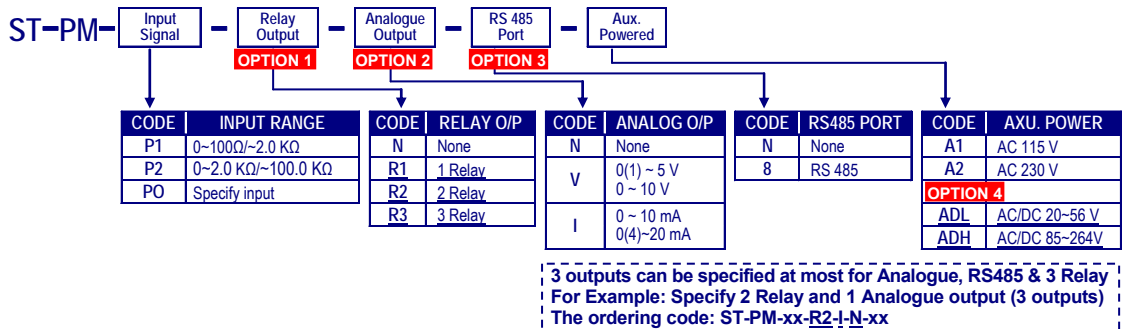

ORDERING INFORMATION

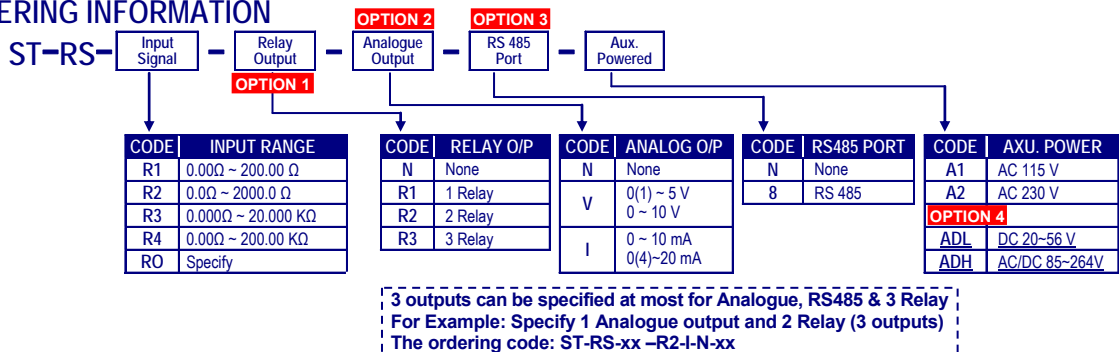

➤ USER LEVEL

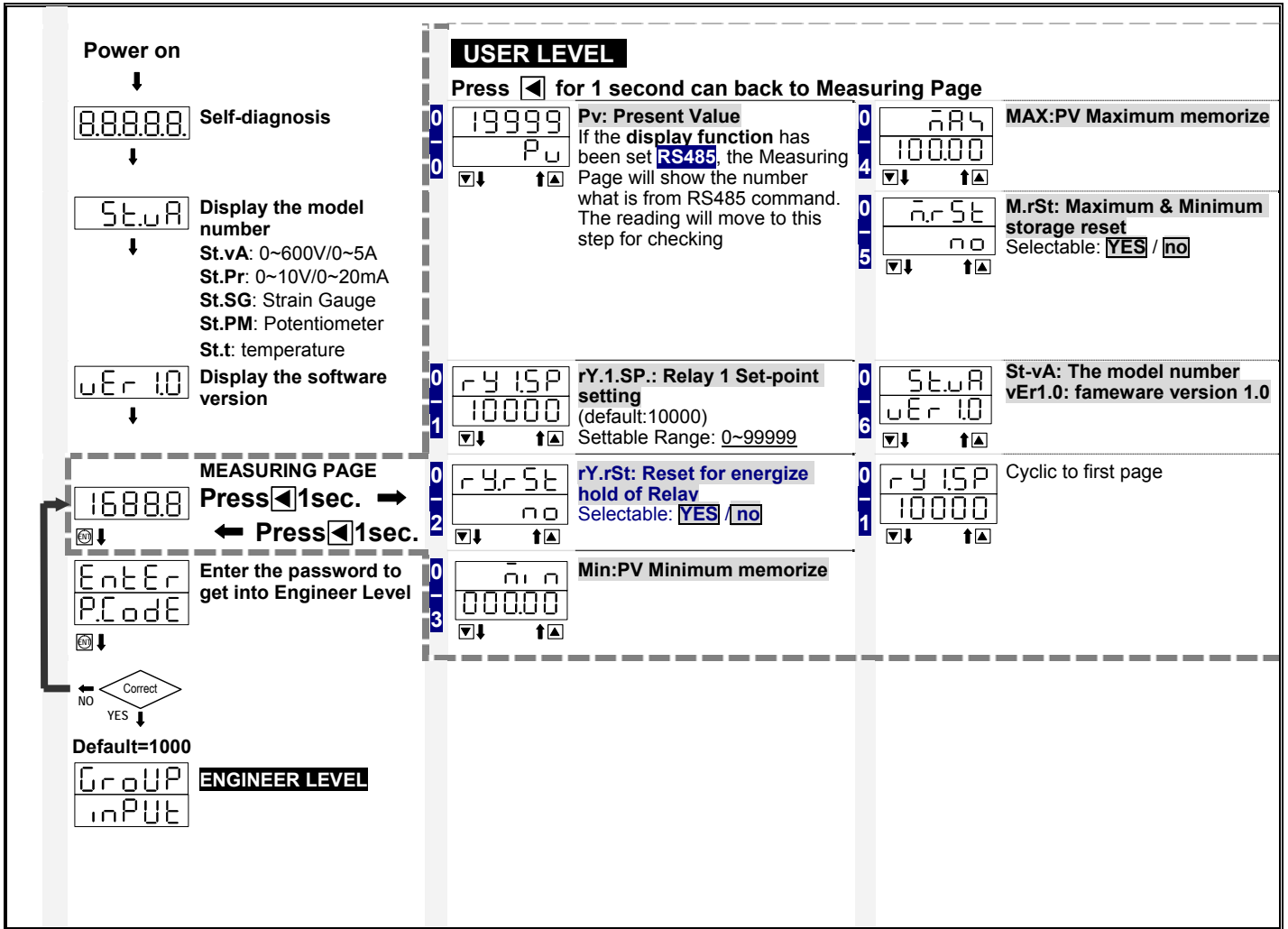

ENGINEER LEVEL – INPUT GROUP

Measuring Page
1688.8

Pass code enter
Enter
P.Code

CHECK
NO
YES
default=1000

INPUT GROUP
Press **ENT** →
← Press **1sec.**

ENGINEER LEVEL

In Function Index Page, press **ENT** to enter **Function Setting Page** for setting;
press **1sec** over 1 second to return **Function Group Page**.

A 0	A.i.TYP A.4-20	The Function is for ST-PR only Ai.TYP: Analog input type & range (Default: A.4-20); Selectable: v.0-10 (0~10V) / v.0-5 (0~5V) / v.1-5 (1~5V) / A.0-10 (0-10mA) / A.0-20 (0~20mA) / A.4-20 (4~20mA) > Press ENT to enter & setting	A 9	Z.S.CLR nonE	Z.S.CLR: Clear Fine Zero & Span Adjustment for PV display (Default: nonE); Range: nonE / Pv.Zro / Pv.SPn / both > Press ENT to enter & setting
A 1	A.i.Lo 0.00	Ai.Lo: Analogue input low (Default: 0.00%); Range: 0.00%~100.00% > Press ENT to enter & setting	A 10	diPLY Pv	diPLY: Display Function (default: Pv); Selectable: Pv / Mini.H / MAX.H / RS485 Pv : Present Value Mini.H : Minimum. Hold MAX.H : Maximum Hold RS485 : Writing to display from RS485 command > Press ENT to enter & setting
A 2	A.i.Hi 100.00	Ai.Hi: Analogue input high (Default: 100.00%); Range: 0.00%~100.00% > Press ENT to enter & setting	A 11	Lo.Cut 0	Lo.Cut: Low Cut to show "0" (default: 0); Settable: ±19999 counts > Press ENT to enter & setting
A 3	Pv.dP 0	Pv.dP: Decimal Point of PV (Default: 0); Range: 0 / 0.0 / 0.00 / 0.000 / 0.0000 > Press ENT to enter & setting	A 12	AvG 1	AvG: Average for PV (default: 1time); Settable: 1(no function)~99times > Press ENT to enter & setting
A 4	Sq.rot no	Sq.rot(Square Root): 開根號 功能選擇 (出廠值: no); 選擇範圍: no / YES > 按 ENT 鍵 進入選擇	A 13	Mv.AvG 1	Mv.AvG: Moving Average (default: 1time); Settable: 1(no function)~99times > Press ENT to enter & setting
A 5	Lo.SC 0	Lo.SC: Low scale (Default: 0); Range: -19999~+29999 > Press ENT to enter & setting	A 14	d.FiLT 0	d.FiLT: Digital filter (default: 0); Selectable: 0(no function)/1~99times > Press ENT to enter & setting
A 6	Hi.SC 19999	Hi.SC: High scale (Default: 199.99); Range: -19999~+29999 > Press ENT to enter & setting	A 15	dn.KEY nonE	dn.KEY(down key): Panel down key Function Setting (default: nonE); Selectable: nonE / rel.pv / pv.hld / m.rst * (ST-SG-PCI ver have this feature) nonE (None): None Lock rel.pv 顯示 Display window will show the relative value (ΔPV) or tare function pv.hld Display will no longer be maintained and that changes to follow the input signal changes, until the contact is opened (OFF) m.rst Function is to enforce the max (min) value of the reversion Press ENT to enter & setting
A 7	Pv.Zro 0	Pv.Zro: Fine Zero Adjustment for PV display (Default: 0); Range: -19999~29999 > Press ENT to enter & setting	A 16	P.Code 0000	P.CodeE: Pass Code for enter Engineer Level (default: 1000); Selectable: 0000~9999 > Press ENT to enter & setting
A 8	Pv.SPn 0	Pv.SPn: Fine Span Adjustment for PV display (Default: 0); Range: -19999~29999 > Press ENT to enter & setting	A 17	F.LoCk nonE	F.LoCk: FUNCTION LEVEL Lock (default: nonE); Selectable: nonE / USER / EnG / ALL nonE : No lock USER : User Level lock EnG : Engineer Level lock ALL : All Level lock > Press ENT to enter & setting

Cyclic to first page

➤ **ENGINEER LEVEL --- RELAY GROUP, ANALOGUE OUTPUT**
 (The group will be hidden, if the converter without the functions)

RELAY GROUP		ANALOGUE OUTPUT GROUP	
GROUP rELAY	Press ENT FN → ← Press ◀ 1sec.	GROUP Ao	Press ENT FN → ← Press ◀ 1sec.
B 1	rY.Sb: Start band for Relay energized (default: 0); Settable: 0~9999 counts ➤ Press ◻ to enter & setting	D 1	Ao.tYP: Analogue Output type selection (default: A.4~20); Settable: v.0-10 (0~10V) / v.0-5 (0~5V) / v.1-5 (1~5V) / A.0-20 (0~20mA) / A.4-20 (4~20mA) / A.0-10 (0-10mA) ➤ Press ◻ to enter & setting
B 2	rY.Sd: Start delay time for Relay energized (default: 0:00.0); Settable: 0:00.0~9(m):59.9(s) ➤ Press ◻ to enter & setting	D 2	Ao.LS: Analogue Low Output relative Low Scale (default: according to Lo.SC); Settable: -19999~19999 ➤ Press ◻ to enter & setting
B 3	rY1.Md: Relay 1 energized mode (default: Hi); Selectable: oFF / Lo / Hi / Lo.HLd / Hi.HLd / do oFF : Turn off the Relay Lo : Low Level Energized; The relay energized when PV < Setpoint. Hi : High Level Energized; The relay energized when PV > Setpoint Lo.HLd : Low Level energized hold; When the PV lower than set-point, the relay will be energized and hold until manual reset by from key in User Level or E.C.I. Hi.HLd : High Level energized hold; When the PV higher than set-point, the relay will be energized and hold until manual reset by from key in User Level or E.C.I. do (Digital Outpu) : Relay energized by RS485 command ➤ Press ◻ to enter & select	D 3	Ao.HS: Analogue High Output relative High Scale (default: according to Hi.SC); Settable: -19999~29999 ➤ Press ◻ to enter & setting
B 4	rY1.HY.: Relay 1 Hysteresis (default: 0); Settable: 0~5000 counts ➤ Press ◻ to enter & setting	D 4	Ao.Zro: Fine Zero Adjustment for Analog Low Output (default: 0); Settable: -19999~29999 ➤ Press ◻ to enter & setting
B 5	rY1.rd: Relay 1 energized delay time (default: 0:00.0); Settable: 0:00.0~9(m):59.9(s) ➤ Press ◻ to enter & setting	D 5	Ao.SPn: Fine Span Adjustment for Analog High Output (default: 0); Settable: -19999~29999 ➤ Press ◻ to enter & setting
B 5	rY1.rd: Relay 1 energized delay time (default: 0:00.0); Settable: 0:00.0~9(m):59.9(s) ➤ Press ◻ to enter & setting	D 6	Z.S.CLr: Zero & Span Clear for Adjustment (default: nonE); Settable: nonE / Ao.Zro / Ao.SPn / both nonE : No clear Ao.Zro : Clear Zero Adjustment Ao.SPn : Clear Span Adjustment both : Clear Zero and Span Adjustment ➤ Press ◻ to enter & setting
B 1	Cyclic to first page	D 7	Ao.LMt: Analog Output High Limit (default: 110.00); Settable: -0.00~110.00% of FS ➤ Press ◻ to enter & setting
B 1	Cyclic to first page	D 1	Cyclic to first page

➤ **ENGINEER LEVEL --- RS485 GROUP**
 (The group will be hidden, if the converter without the function)

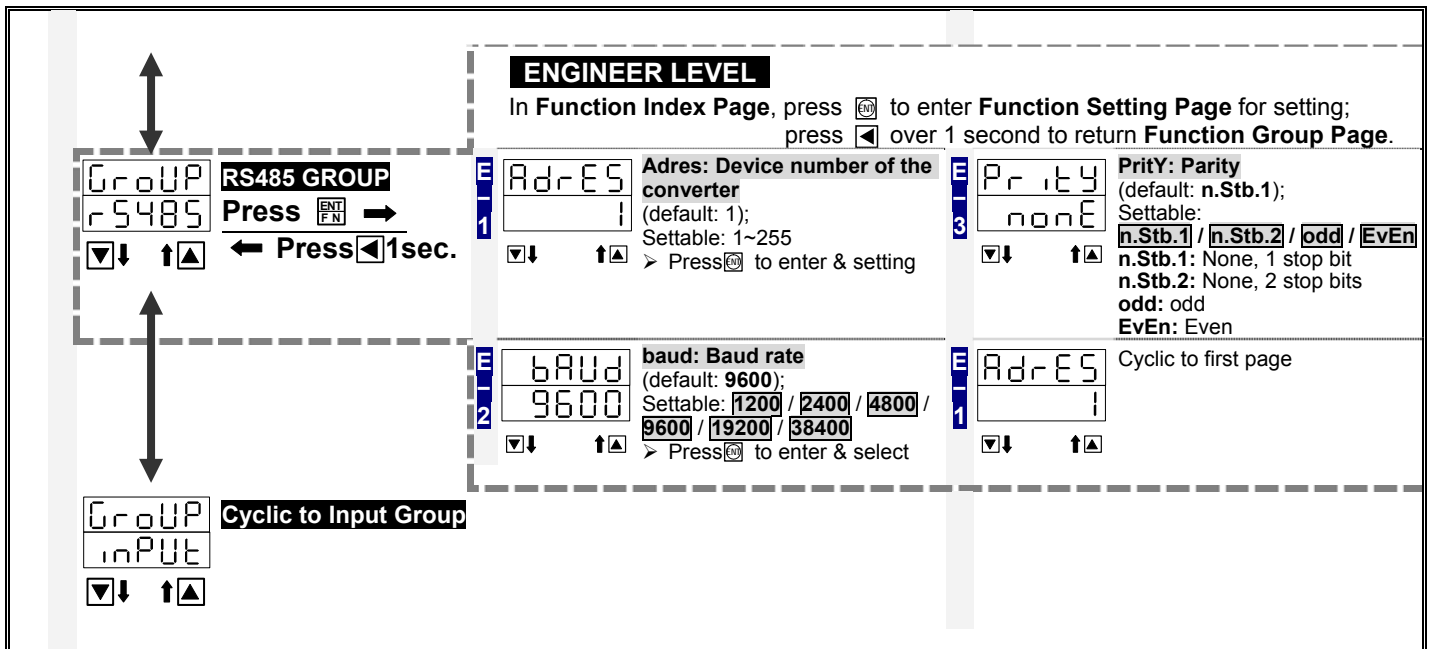

RS485 ModBus RTU Mode

1. Function 03H (Read Holding Registers)

Request Data Frame; EX: Read the data of display value(0000H starts from 1 Word)

SLAVE Address	FUNCTION	Starting Address Hi	Starting Address Lo	No. of Word Hi	No. of Word Lo	CRC Lo	CRC Hi
01H	03H	00H	00H	00H	01H	84H	0AH

Response Data Frame; EX: The response value is "0"

SLAVE Address	FUNCTION	Byte count	Data Hi	Data Lo	CRC Lo	CRC Hi
01H	03H	02H	00H	00H	B8H	44H

Request Data Frame (EX: Continue to request the data of 10 points)

SLAVE Address	FUNCTION	Starting Address Hi	Starting Address Lo	No. of Word Hi	No. of Word Lo	CRC Lo	CRC Hi
01H	03H	00H	00H	00H	0AH	C5H	CDH

Response Data Frame

SLAVE Address	FUNCTION	Byte count	Data(1) Hi	Data(1) Lo	Data(10) Hi	Data(10) Lo	CRC Lo	CRC Hi
01H	03H	14H	00H	00H	01H	00H	--	--

2. Writing Command by Function 06H (Preset Single Register)

Request Data Frame

SLAVE Address	FUNCTION Code	Starting Address Hi	Starting Address Lo	Preset DATA Hi	Preset DATA Lo	CRC Lo	CRC Hi
01H	06H	00H	00H	00H	02H	08H	0BH

Response Data Frame

SLAVE Address	FUNCTION Code	Starting Address Hi	Starting Address Lo	Preset DATA Hi	Preset DATA Lo	CRC Lo	CRC Hi
01H	06H	00H	00H	00H	02H	08H	0BH

ADDRESS TABLE ****Address numbers are Hexadecimal**

➤ **User Level**

Name	Address	Range	Explain	Initial	Write/Read	Note
PV	0000h	-19999~29999	Present Value		R	
RY1.SP	0001h	-19999~29999	Relay 1 Set Point	10000	R/W	
RELAY STATUS	0002h		Relay Status bit0=1 Relay 1 ON bit0=0 Relay 1 OFF	00h	R/W	
min	0003h	-19999~29999	The Minimum of PV		R	
max	0004h	-19999~29999	The Maximum of PV		R	
SYSTEM STATUS	0005h		SYSTEM STATUS bit0=1 EEP fail; bit1=1 Input calibration fail; bit2=1 Input calibration NG; bit3=1 Analogue Output calibration fail; bit4=1 Analogue Output calibration NG	00h	R	
rst	0006h	0~1	Reset Maximum & Minimum Value 0:No 1:Yes	00h	R/W	
rs485	0007h	-19999~29999	PV showing from RS485 command(data)	00h	R/W	

➤ Engineer Level

[Input Group]						
Name	Address	Range	Explain	Initial	Write/Read	Note
RESERVED	0008h		Not use unless ST-PR			
AITYP		0~5	ST-PR Analogue Input Type 0:0~10V 1:0~5V 2:1~5V 3:0~20mA 4:4~20mA 5:0~10mA	00h	R/W	
ALo	0009h	0.00~100.00%	Input Low	0	R/W	
AHi	000Ah	0.00~100.00%	Input High	10000	R/W	
PuDP	000Bh	0~4	PV Decimal Point 0: 00000 1: 0000.0 2: 000.00 3: 00.000 4: 0.0000	00h	R/W	
LoSC	000Ch	-19999~29999	Low Scale	0	R/W	
HiSC	000Dh	-19999~29999	High Scale	19999	R/W	
PuZro	000Eh	-19999~29999	PV ZERO	0	R/W	
PuSPn	000Fh	-19999~29999	PV SPAN	0	R/W	
PSClr	0010h	0~3	The clear of PV_ZERO and PV_SPAN 0:None 1:PV_ZERO 2:PV_SPAN 3: Both	00h	R/W	
dsPLY	0011h	0~3	Display Mode 0:PV 1: Minimum Hold 2: Maximum Hold 3: RS485	00h	R/W	
LoCut	0012h	-19999~19999	Low Cut	0	R/W	
Avg	0013h	1~99	Average for Present Value	5	R/W	
dFilt	0014h	0~99	Digital Filter	0	R/W	
PCode	0015h	0000~9999	Pass Code	1000	R/W	
FLoCk	0016h	0~3	Function Lock 0: none 1: User Level 2: Engineer Level 3: All	00h	R/W	

[Relay Group]						
Name	Address	Range	Explain	Initial	Write/Read	Note
rsb	0017h	0000~9999	Start Band of Relay	0	R/W	
rsd	0018h	0000~5999 (0.1second)	Start Delay Time of Relay	0	R/W	

Name	Address	Range	Explain	Initial	Write/Read	Note
ry1rd	0019h	0~5	Relay1 Energized Mode 0: oFF(no use); 1: Lo(Low Energized);	02h	R/W	

			2: Hi (High Energized) 3: Lo Hold (Low Energized Hold) 4: High Hold (High Energized Hold) 5: DO (Digital Output);			
rY IHY	001Ah	0000~5000	Hysteresis of Relay1	0	R/W	
rY Ird	001Bh	0000~5999 (0.1second)	Energized Delay Time of Relay1	0	R/W	
rY IFd	001Ch	0000~5999 (0.1second)	De-Energized Delay Time of Relay1	0	R/W	
rY rSt	001Dh	0~1	Reset for Relay Energized Hold 0: No 1: Yes	00h	R/W	

[AO Group]

Name	Address	Range	Explain	Initial	Write/Read	Note
AOtYP	001Eh	0~5	Analog Output Type 0: 0~10V 1: 0~5V 2: 1~5V 3: 0~20mA 4: 4~20mA 5: 0~10mA	00h	R/W	
AOtLS	001Fh	-19999~29999	Analogue Output Low Scale	0	R/W	
AOtHS	0020h	-19999~29999	Analogue Output High Scale	19999	R/W	
AOtLt	0021h	00.00%~110.00%	Analogue Output High Limit	11000	R/W	
AOtClr	0022h	0~3	The clear of AO_ZERO and AO_SPAN 0: None 1: AO_ZERO 2: AO_SPAN 3: Both	00h	R/W	

[RS485 Group]

Name	Address	Range	Explain	Initial	Write/Read	Note
AdRES	0023h	1~255	RS485 address	1	R/W	
BAud	0024h	0~5	RS485 baud rate 0:1200 1:2400 2:4800 3:9600 4:19200 5:38400	03h	R/W	
Pr tY}}	0025h	0~3	RS485 parity 0: n-8-1 1: n-8-2, 2: odd, 3: even,	01h	R/W	

■ Field Calibration Group [for ST-SG / ST-PM / ST-RS only]

Please according to the numbers to do the field calibration (1⇒2⇒3⇒4⇒5⇒6)

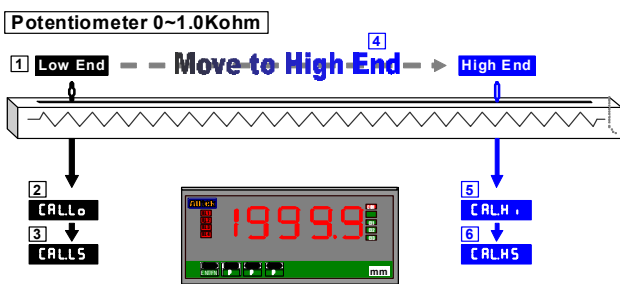

Please according to the numbers to do the field calibration (1⇒2⇒3⇒4⇒5⇒6)

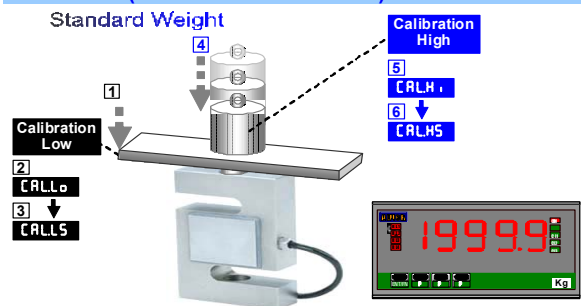

INDEX	FUNCTION DESCRIPTION	PARAMETERS & SETTING	SET
16888	Measuring Page		
FUN ENT ↓ EntEr ↻ P.CodE ✓&△ ↓	Pass Code Page		
EntEr FUN ENT ↻ ↻ F.CodE 0000 ↓ ✓&△ 2000 ↻ FUN ENT Nest Page	Pass Code Page for Field Calibration Level	Enter the exactly pass code of the meter to access the Field Calibration Level. Otherwise, it will be turning back to measuring page.	

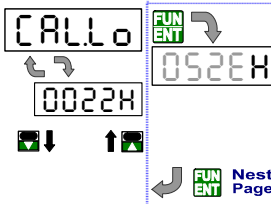
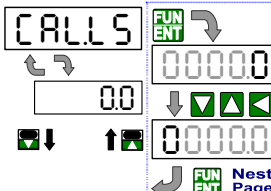
<p>NO</p> <p>Pass Code</p> <p>FUN ENT ↓ YES</p>		<p>Adjust the structure of machinery to the lower signal output status(or any lower status).</p>	
<p>F-1</p>  <p>FUN ENT ↻</p> <p>Nest Page</p>	<p>CALLo (CAL.Lo): Field Calibration Low.</p> <p>The low calibration is not need the exactly "zero" to calibrate because of the "field calibration" function could be calibrate any lower point.</p>	<ul style="list-style-type: none"> Waiting for the value till stable, pressed FUN ENT Key to read signal low of sensing device. Waiting for above reading stable (around 3~5seconds), press FUN ENT Key again to complete the calibration lower point, and go to [CALL5]. 	
<p>F-2</p>  <p>FUN ENT ↻</p> <p>Nest Page</p>	<p>CALL5 (CAL.LS): the value to be set is relative to Field Calibration low point.</p>	<p>Settable range: -19999~29999</p> <p>◀Shift ▲Up ▼Down FUN ENTEnter</p>	

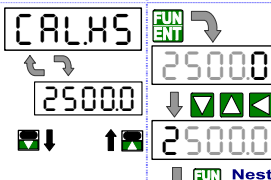
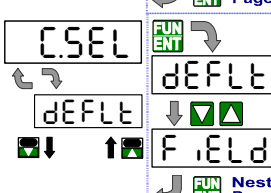
	<p>Adjust the machinery structure to the higher signal output status(or any higher status).</p>		
<p>F-3</p>  <p>FUN ENT ↻</p> <p>Nest Page</p>	<p>CALHi (CAL.Hi): Field Calibration High.</p> <p>The high calibration is not need the exactly "span" to calibrate because of the "field calibration" function could be calibrating any higher point.</p>	<ul style="list-style-type: none"> Waiting for the value till stable, pressed FUN ENT Key to read signal high of sensing device. Waiting for above reading stable (around 3~5seconds), press FUN ENT Key again to complete the calibration higher point, and go to [CALHS]. 	
<p>F-4</p>  <p>FUN ENT ↻</p> <p>Nest Page</p>	<p>CALHS (CAL.HS): the value to be set is relative to Field Calibration high point.</p>	<p>Settable range: -19999~29999</p> <p>◀Shift ▲Up ▼Down FUN ENTEnter</p>	
<p>F-5</p>  <p>FUN ENT ↻</p> <p>Nest Page</p>	<p>CSEL (C.SEL): Calibration parameter selection;</p> <p>As the user finished the procedures of field calibration, the field calibration datum has been saved in EEPROM and it can't change the default(factory) calibration datum. Even the field calibration has been done, the user can still select either default calibration or field calibration.</p>	<p>Programmable:</p> <p>DEFLE(default): factory calibration points and factors</p> <p>FELD(field): field calibration points and factors</p> <p>▲Up ▼Down FUN ENTEnter</p> <ul style="list-style-type: none"> If the user select field calibration of the [LoSC](step A-4) and [HiSC](A-5) will be replaced by the [CALL5] and [CALHS] which it can not to be change by anyone. If user has to change the scaling, it's the only way to access field calibration level to set in [CALL5](step F-2) and [CALHS](step F-4). Please double check the [LoSC](step A-4) and [HiSC](A-5) whether are correct after selection the DEFLE or FELD. 	