

Instruction Manual

HI 83099

COD and Multiparameter Bench Photometer

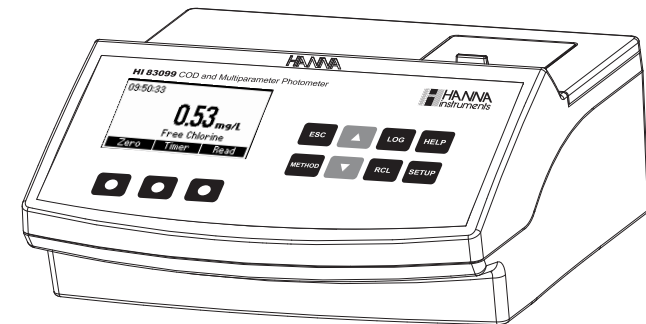

Dear Customer,

Thank you for choosing a Hanna product. Please read this instruction manual carefully before using the instrument. This manual will provide you with the necessary information for the correct use of the instrument. If you need additional technical information, do not hesitate to e-mail us at tech@hannainst.com.

TABLE OF CONTENTS

PRELIMINARY EXAMINATION	3	IRON HR	66
GENERAL DESCRIPTION	3	IRON LR	68
ABBREVIATIONS	4	MAGNESIUM	71
SPECIFICATIONS	4	MANGANESE HR	73
PRECISION AND ACCURACY	4	MANGANESE LR	75
PRINCIPLE OF OPERATION	5	MOLYBDENUM	78
FUNCTIONAL DESCRIPTION	6	NICKEL HR	81
TIPS FOR AN ACCURATE MEASUREMENT	8	NICKEL LR	83
HEALTH & SAFETY	11	NITRATE	86
METHOD REFERENCE TABLE	11	NITRITE HR	88
OPERATIONAL GUIDE	12	NITRITE LR	90
SETUP	14	DISSOLVED OXYGEN	92
HELP MODE	16	OXYGEN DEMAND, CHEMICAL HR	94
SAMPLE PREPARATION	17	OXYGEN DEMAND, CHEMICAL MR	97
ALUMINUM	21	OXYGEN DEMAND, CHEMICAL LR	100
ALKALINITY	23	OZONE	103
AMMONIA MR	25	pH	106
AMMONIA LR	27	PHOSPHATE HR	108
BROMINE	29	PHOSPHATE LR	110
CALCIUM	31	PHOSPHORUS	112
FREE CHLORINE	33	POTASSIUM HR	114
TOTAL CHLORINE	36	POTASSIUM MR	116
CHLORINE DIOXIDE	39	POTASSIUM LR	118
CHROMIUM VI HR	42	SILICA	120
CHROMIUM VI LR	44	SILVER	122
COLOR OF WATER	46	SULFATE	125
COPPER HR	48	ZINC	127
COPPER LR	50	ERRORS AND WARNINGS	129
CYANURIC ACID	52	DATA MANAGEMENT	130
FLUORIDE	54	STANDARD METHODS	131
CALCIUM HARDNESS	56	ACCESSORIES	132
MAGNESIUM HARDNESS	59	WARRANTY	135
HYDRAZINE	62	HANNA LITERATURE	135
IODINE	64		

All rights are reserved. Reproduction in whole or in part is prohibited without the written consent of the copyright owner, Hanna Instruments Inc., Woonsoket, Rhode Island, 02895, USA.

PRELIMINARY EXAMINATION

Please examine this product carefully. Make sure that the instrument is not damaged. If any damage occurred during shipment, please notify your local Hanna Office.

Each meter is supplied complete with:

- Four Sample Cuvettes and Caps
- Sample Preparation Kit (for turbid or concentrated samples see page 17)
- Cloth for wiping cuvettes (1 pcs)
- 60 mL glass bottle for dissolved oxygen analysis (1 pcs)
- Scissors
- AC/DC Power Adapter
- Instruction Manual

The sample preparation kit contains:

- 4 cuvettes (10 mL) with caps
- 2 plastic beakers (100 and 170 mL)
- 1 graduated cylinder (100 mL)
- 1 syringe with screw rim (60 mL)
- 1 syringe (5 mL)
- 1 funnel
- 25 filter discs
- 1 spoon
- 2 pipettes
- Carbon powder packets (50 pcs)
- 1 Demineralizer Bottle with filter cap for about 12 liters of deionized water (depending on the hardness level of water to be treated)

Note: Save all packing material until you are sure that the instrument works correctly. Any defective item must be returned in its original packing with the supplied accessories.

GENERAL DESCRIPTION

HI 83099 is a multiparameter bench photometer dedicated for Laboratory analysis. It measures 47 different methods using specific liquid or powder reagents. The amount of reagent is precisely dosed to ensure maximum reproducibility.

HI 83099 bench photometer can be connected to a PC via an USB cable. The optional **HI 92000** Windows® Compatible Software helps users manage all their results.

HI 83099 has a powerful interactive user support that assists the user during the analysis process.

Each step in the measurement process is help supported. A tutorial mode is available in the Setup Menu.

ABBREVIATIONS

EPA:	US Environmental Protection Agency
°C:	degree Celsius
°F:	degree Fahrenheit
µg/L:	micrograms per liter (ppb)
mg/L:	milligrams per liter (ppm)
g/L:	grams per liter (ppt)
mL:	milliliter
HR:	high range
MR:	medium range
LR:	low range
PAN:	1-(2-pyridylazo)-2-naphthol
TPTZ:	2,4,6-tri-(2-pyridyl)-1,3,5-triazine

SPECIFICATIONS

Light Life	Life of the instrument
Light Detector	Silicon Photocell
Environment	0 to 50°C (32 to 122°F); max 90% RH non-condensing
Power Supply	external 12 Vdc power adapter built-in rechargeable battery
Dimensions	235 x 200 x 110 mm (9.2 x 7.87 x 4.33")
Weight	0.9 Kg

For specifications related to each method (e.g. range, resolution, etc.) refer to the related measurement section.

PRECISION AND ACCURACY

Precision is how closely repeated measurements agree with each other. Precision is usually expressed as standard deviation (SD).

Accuracy is defined as the nearness of a test result to the true value.

Although good precision suggests good accuracy, precise results can be inaccurate. The figure explains these definitions.

For each method, the accuracy is expressed in the related measurement section.

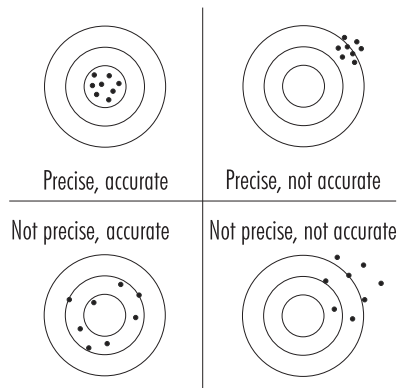

PRINCIPLE OF OPERATION

Absorption of light is a typical phenomenon of interaction between electromagnetic radiation and matter. When a light beam crosses a substance, some of the radiation may be absorbed by atoms, molecules or crystal lattices.

If pure absorption occurs, the fraction of light absorbed depends both on the optical path length through the matter and on the physical-chemical characteristics of substance according to the Lambert-Beer Law:

$$-\log \frac{I}{I_0} = \epsilon_{\lambda} c d$$

or

$$A = \epsilon_{\lambda} c d$$

Where:

$-\log I/I_0$	Absorbance (A)
I_0	intensity of incident light beam
I	intensity of light beam after absorption
ϵ_{λ}	molar extinction coefficient at wavelength λ
c	molar concentration of the substance
d	optical path through the substance

Therefore, the concentration "c" can be calculated from the absorbance of the substance as the other factors are known.

Photometric chemical analysis is based on the possibility to develop an absorbing compound from a specific chemical reaction between sample and reagents.

Given that the absorption of a compound strictly depends on the wavelength of the incident light beam, a narrow spectral bandwidth should be selected as well as a proper central wavelength to optimize measurements.

The optical system of **HI 83099** is based on special subminiature tungsten lamps and narrow-band interference filters to guarantee both high performance and reliable results.

Five measuring channels allow a wide range of tests.

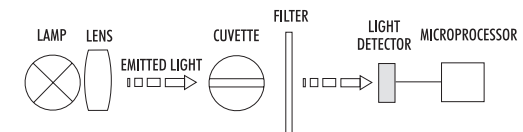

Instrument block diagram (optical layout)

A microprocessor controlled special tungsten lamp emits radiation which is first optically conditioned and beamed through the sample contained in the cuvette. The optical path is fixed by the diameter of the cuvette. Then the light is spectrally filtered to a narrow spectral bandwidth, to obtain a light beam of intensity I_0 or I . The photoelectric cell collects the radiation I that is not absorbed by the sample and converts it into an electric current, producing a potential in the mV range.

The microprocessor uses this potential to convert the incoming value into the desired measuring unit and to display it on the LCD.

The measurement process is carried out in two phases: first the meter is zeroed and then the actual measurement is performed.

The cuvette has a very important role because it is an optical element and thus requires particular attention. It is important that both the measurement and the calibration (zeroing) cuvette are optically identical to provide the same measurement conditions. Most methods use the same cuvette for both, so it is important that measurements are taken at the same optical point. The instrument and the cuvette cap have special marks that must be aligned in order to obtain better reproducibility.

The surface of the cuvette must be clean and not scratched. This is to avoid measurement interference due to unwanted reflection and absorption of light. It is recommended not to touch the cuvette walls with hands.

Furthermore, in order to maintain the same conditions during the zeroing and the measurement phases, it is necessary to cap the cuvette to prevent any contamination.

FUNCTIONAL DESCRIPTION



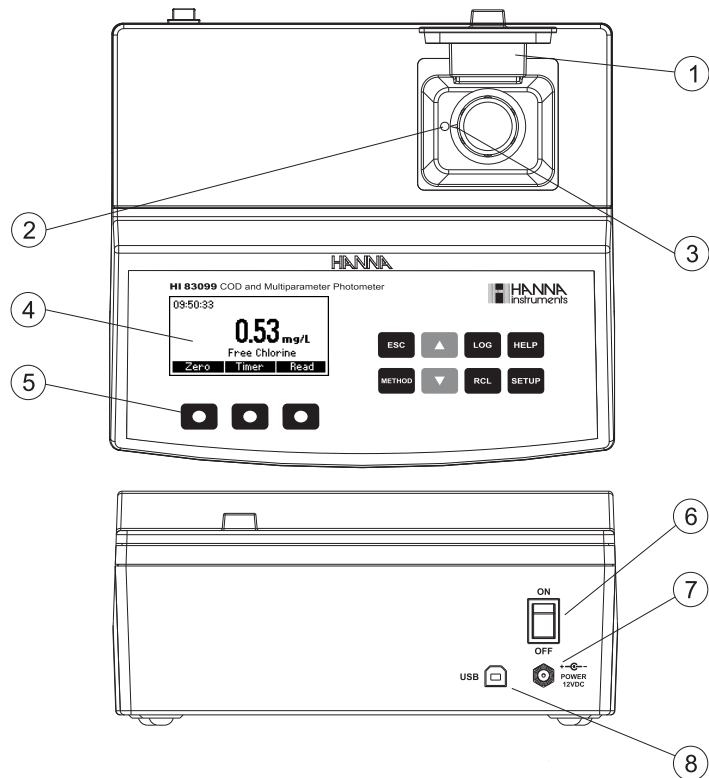





INSTRUMENT DESCRIPTION



- 1) Open Cuvette Lid
- 2) Indexing mark
- 3) Cuvette point
- 4) Liquid Crystal Display (LCD)
- 5) Splash proof keypad
- 6) ON/OFF power switch
- 7) Power input connector
- 8) USB connector

KEYPAD DESCRIPTION

The keypad contains 8 direct keys and 3 functional keys with the following functions:

-  Press to perform the function displayed above it on the LCD.
-  Press to exit the current screen.
-  Press to access the select method menu.
-  Press to move up in a menu or a help screen, to increment a set value, to access second level functions.
-  Press to move down in a menu or a help screen, to decrement a set value, to access second level functions.
-  Press to log the current reading.
-  Press to recall the log.
-  Press to display the help screen.
-  Press to access the setup screen.

TIPS FOR AN ACCURATE MEASUREMENT

The instructions listed below should be carefully followed during testing to ensure most accurate results.

- Color or suspended matter in large amounts may cause interference, and should be removed by treatment with active carbon and filtration: refer to Sample Preparation Chapter (page 17).
- Ensure the cuvette is filled correctly: the liquid in the cuvette forms a convexity on the top; the bottom of this convexity must be at the same level as the 10 mL mark.

COLLECTING AND MEASURING SAMPLES

- In order to measure exactly 0.5 mL of reagent with the 1 mL syringe:
 - (a) push the plunger completely into the syringe and insert the tip into the solution.
 - (b) pull the plunger up until the lower edge of the seal is exactly on the 0.0 mL mark.
 - (c) take out the syringe and clean the outside of the syringe tip. Be sure that no drops are hanging on the tip of the syringe, if so eliminate them. Then, keeping the syringe in vertical position above the cuvette, push the plunger down into the syringe until the lower edge of the seal is exactly on the 0.5 mL mark. Now the exact amount of 0.5 mL has been added to the cuvette, even if the tip still contains some solution.

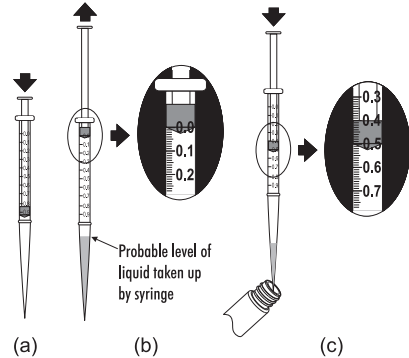

USING LIQUID AND POWDER REAGENTS

- Proper use of the dropper:
 - (a) for reproducible results, tap the dropper on the table for several times and wipe the outside of the dropper tip with a cloth.
 - (b) always keep the dropper bottle in a vertical position while dosing the reagent.



- Proper use of the powder reagent packet:
 - (a) use scissors to open the powder packet;
 - (b) push the edges of the packet to form a spout;
 - (c) pour out the content of the packet.

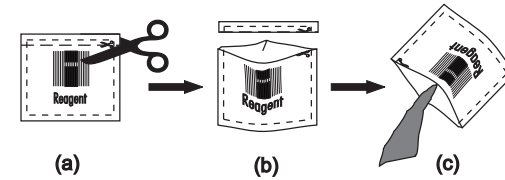

USING CUVETTES

- Proper mixing is very important for reproducibility of the measurements. The right way of mixing a cuvette is specified for each method in the related chapter.
 - (a) **invert the cuvette** a couple of times or for a specified time: hold the cuvette in the vertical position. Turn the cuvette upside-down and wait for all of the solution to flow to the cap end, then return the cuvette to the upright vertical position and wait for all of the solution to flow to the cuvette bottom. This is one inversion. The correct speed for this mixing technique is 10-15 complete inversions in 30 seconds.

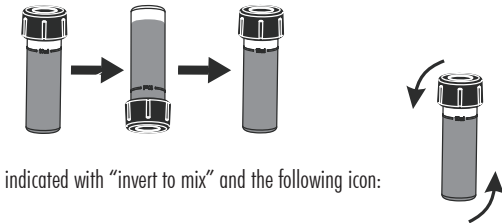

This mixing technique is indicated with "invert to mix" and the following icon:

- (b) **shaking the cuvette**, moving the cuvette up and down. The movement may be gentle or vigorous. This mixing method is indicated with "shake gently" or "shake vigorously", and one of the following icons:

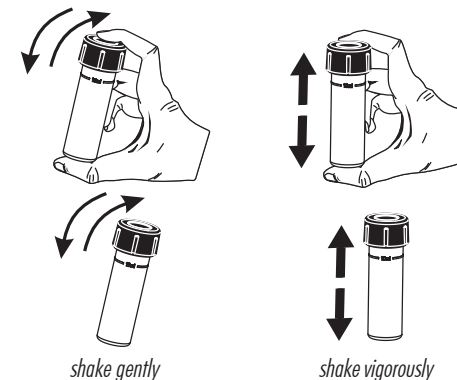

- Pay attention to push the cuvette completely down in the holder and to align the white point on the cap to the indexing mark on the meter.

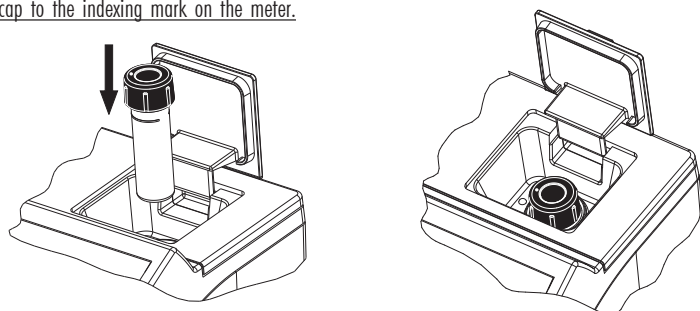

- In order to avoid reagent leaking and to obtain more accurate measurements, close the cuvette first with the supplied HDPE plastic stopper and then the black cap.
- Each time the cuvette is used, the cap must be tightened to the same degree.
- Whenever the cuvette is placed into the measurement cell, it must be dry outside, and free of fingerprints, oil or dirt. Wipe it thoroughly with HI 731318 or a lint-free cloth prior to insertion.
- Shaking the cuvette can generate bubbles in the sample, causing higher readings. To obtain accurate measurements, remove such bubbles by swirling or by gently tapping the cuvette.
- Do not let the reacted sample stand too long after reagent is added. For best accuracy, respect the timings described in each specific method.
- It is possible to take multiple readings in a row, but it is recommended to take a new zero reading for each sample and to use the same cuvette for zeroing and measurement when possible (for most precise results follow the measurement procedures carefully).
- Discard the sample immediately after the reading is taken, or the glass might become permanently stained.
- All the reaction times reported in this manual are at 25 °C (77 °F). In general, the reaction time should be increased for temperatures lower than 20 °C (68 °F), and decreased for temperatures higher than 25 °C (77 °F).

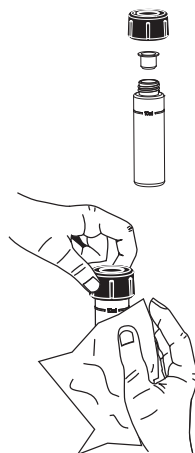

INTERFERENCES

- In the method measurement section the most common interferences that may be present in an average sample matrix have been reported. It may be that for a particular treatment process other compounds do interfere with the method of analysis.

HEALTH & SAFETY



- The chemicals contained in the reagent kits may be hazardous if improperly handled.
- Read the Material Safety Data Sheet (MSDS) before performing tests.
- **Safety equipment:** Wear suitable eye protection and clothing when required, and follow instructions carefully.
- **Reagent spills:** If a reagent spill occurs, wipe up immediately and rinse with plenty of water. If reagent contacts skin, rinse the affected area thoroughly with water. Avoid breathing released vapors.
- **Waste disposal:** for proper disposal of reagent kits and reacted samples, refer to the Material Safety Data Sheet (MSDS).

METHOD REFERENCE TABLE

Method	Method description	Page	Method	Method description	Page
1	Aluminum	21	25	Manganese LR	75
2	Alkalinity	23	26	Molybdenum	78
3	Ammonia MR	25	27	Nickel HR	81
4	Ammonia LR	27	28	Nickel LR	83
5	Bromine	29	29	Nitrate	86
6	Calcium	31	30	Nitrite HR	88
7	Free Chlorine	33	31	Nitrite LR	90
8	Total Chlorine	36	32	Dissolved Oxygen	92
9	Chlorine Dioxide	39	33	COD HR	94
10	Chromium VI HR	42	34	COD MR	97
11	Chromium VI LR	44	35	COD LR	100
12	Color of Water	46	36	Ozone	103
13	Copper HR	48	37	pH	106
14	Copper LR	50	38	Phosphate HR	108
15	Cyanuric Acid	52	39	Phosphate LR	110
16	Fluoride	54	40	Phosphorus	112
17	Calcium Hardness	56	41	Potassium HR	114
18	Magnesium Hardness	59	42	Potassium MR	116
19	Hydrazine	62	43	Potassium LR	118
20	Iodine	64	44	Silica	120
21	Iron HR	66	45	Silver	122
22	Iron LR	68	46	Sulfate	125
23	Magnesium	71	47	Zinc	127
24	Manganese HR	73			

OPERATIONAL GUIDE

POWER CONNECTION AND BATTERY MANAGEMENT

The meter can be powered from an AC/DC adapter (included) or from the built-in rechargeable battery.

Note: Always turn the meter off before unplugging it to ensure no data is lost.

When the meter switches ON, it verifies if the power supply adapter is connected. The battery icon on the LCD will indicate the battery status:

- battery is charging from external adapter
- battery fully charged (meter connected to AC/DC adapter)

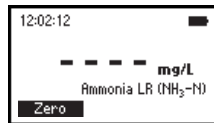
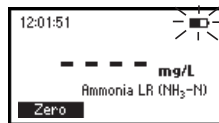

- battery capacity (no external adapter)

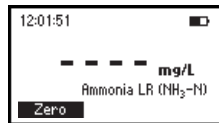

- battery Low (no external adapter)

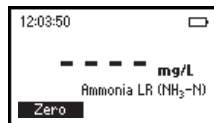

- battery Dead (no external adapter)

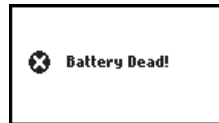

METHOD SELECTION

- Turn the instrument ON via the ON/OFF power switch.
- The meter will perform an autodiagnostic test. During this test, the Hanna Instrument logo will appear on the LCD. After 5 seconds, if the test was successful, the last method used will appear on the display.
- In order to select the desired method press the **METHOD** key and a screen with the available methods will appear.
- Press the **▲ ▼** keys to highlight the desired method. Press **Select**.

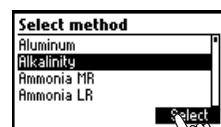
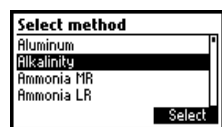

- After the desired method is selected, follow the measurement described in the related section.
- Before performing a test you should read all the instructions carefully.

DATA MANAGEMENT

The instrument features a data log function to help you keep track of all your analysis. The data log can hold 200 individual measurements. Storing, viewing and deleting the data is possible using the **LOG** and **RCL** keys.

Storing data: You can store only a valid measurement. Press **LOG** and the last valid measurement will be stored with date and time stamps.

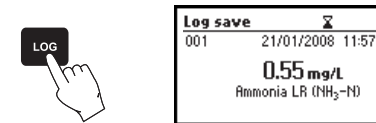

Viewing and deleting: You can view and delete the data log by pressing the **RCL** key. You can only delete the last saved measurement. Additionally, you can delete the data records all at once.

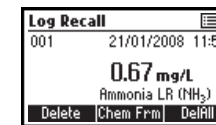
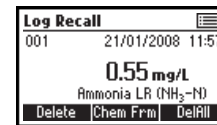

CHEMICAL FORM

Chemical form conversion factors are pre-programmed into the instrument and are method specific. In order to view the displayed result in the desired chemical form press **▲** or **▼** to access the second level function and then press the **Chem Frm** key to toggle between the available chemical forms for the selected method.

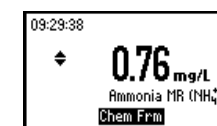
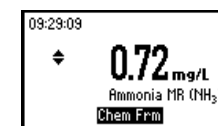

SPECIAL CONVERSIONS

For Magnesium and Calcium Hardness, special conversion factors can be used to convert the readings from mg/L to French degrees (°f), German degrees (°dH) and English degrees (°E) of hardness. This can be achieved by pressing **▲** or **▼** to access the second level functions and then press the **Unit** key to toggle between °f, °dH, °E and mg/L.

SETUP

In the Setup mode the instrument's parameters can be changed. Some parameters affect the measuring sequence and others are general parameters that change the behavior or appearance of the instrument.

Press **SETUP** to enter the setup mode.

Press **ESC** or **SETUP** to return to the main screen.

A list of setup parameters will be displayed with currently configured settings. Press **HELP** for additional information.

Press the **▲ ▼** keys to select a parameter and change the value as follows:



Backlight

Values: 0 to 8.

Press the **Modify** key to access the backlight value.

Use the **◀ ▶** functional keys or the **▲ ▼** keys to increase or decrease the value.

Press the **Accept** functional key to confirm or **ESC** to return to the setup menu without saving the new value.

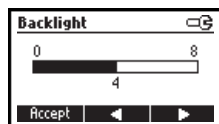
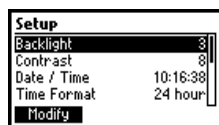

Contrast

Values: 0 to 20.

This option is used to set the display's contrast.

Press the **Modify** key to change the display's contrast.

Use the **◀ ▶** functional keys or the **▲ ▼** keys to increase or decrease the value.

Press the **Accept** key to confirm the value or **ESC** to return to the setup menu without saving the new value.

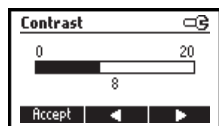
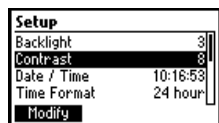

Date / Time

This option is used to set the instrument's date and time.

Press the **Modify** key to change the date/time.

Press the **◀ ▶** functional keys to highlight the value to be modified (year, month, day, hour, minute or second). Use the **▲ ▼** keys to change the value.

Press the **Accept** key to confirm or **ESC** to return to the setup without saving the new date or time.

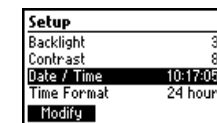

Time format

Option: AM/PM or 24 hour.

Press the functional key to select the desired time format.

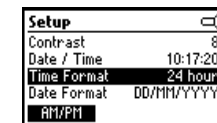

Date format

Press the **Modify** key to change the Date Format.

Use the **▲ ▼** keys to select the desired format.

Press **Accept** functional key to confirm or **ESC** to return to the setup menu without saving the new format.

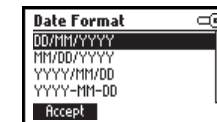
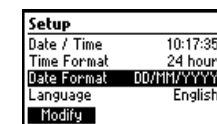

Language

Press the corresponding key to change the language.

If the new language cannot be loaded, the previously selected language will be reloaded.



Tutorial

Option: Enable or Disable.

If enabled this option will provide the user short guide related to the current screen.

Press the functional key to enable/disable the tutorial mode.

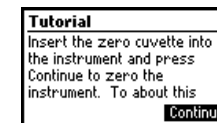
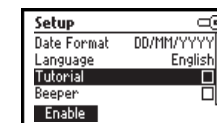

Beeper

Option: Enable or Disable.

When enabled, a short beep is heard every time a key is pressed. A long beep alert sounds when the pressed key is not active or an error is detected.

Press the functional key to enable/disable the beeper.

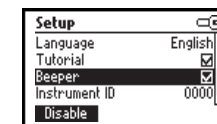

Instrument ID

Option: 0 to 9999.

This option is used to set the instrument's ID (identification number). The instrument ID is used while exchanging data with a PC.

Press the **Modify** key to access the instrument ID screen. Press the **▲ ▼** keys in order to set the desired value.

Press the **Accept** key to confirm the value or **ESC** to return to the setup menu without saving the new value.

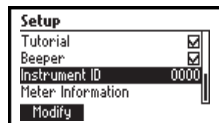

Meter information

Press the **Select** key to view the instrument model, firmware version, language version and instrument serial number.

Press **ESC** to return to the Setup mode.

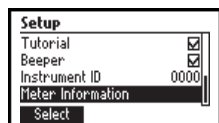

HELP MODE

HI 83099 offers an interactive contextual help mode that assists the user at any time.

To access the help screens press **HELP**.

The instrument will display additional information related to the current screen. To read all the available information, scroll the text using the **▲ ▼** keys.

Press the **Support** key to access a screen with Hanna service centers and their contact details.

Press the **Accessories** key to access a list of instrument reagents and accessories.

To exit support or accessories screens press **ESC** and the instrument will return to the previous help screen.

To exit help mode press the **HELP** or **ESC** key again and the meter will return to the previously selected screen.

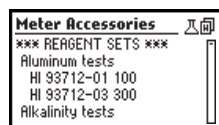
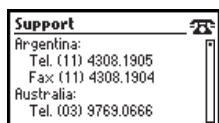
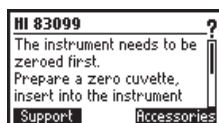

SAMPLE PREPARATION

SAMPLE PREPARATION PROCEDURE

The following Sample Preparation Procedure applies in case of:

- Samples with color or suspended matter (turbidity).
- Concentrated samples, for which the analysis result is over the range of the parameter.

Use the accessories contained in the Sample Preparation Kit to prepare the sample according to the following instructions.

COLORED OR TURBID SAMPLES:

Colored or suspended matter in large amounts may cause interference. They should be removed by treatment with active carbon and filtration.

- If the water sample contains suspended matter, let it stand in a beaker until most of the solid particles have settled. Then, use the pipette to transfer the supernatant solution to the other beaker. To prevent the displacement of the settled solids at the bottom of the beaker, do not induce air bubbles into the solution.
- Measure 100 mL of sample with the graduated cylinder.

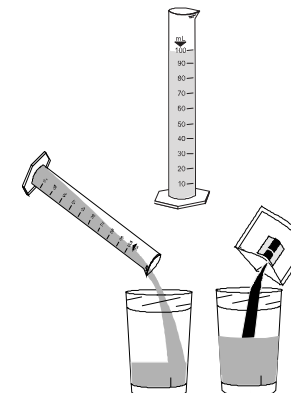

- If the solution still contains some turbidity or color, pour it in the large 170 mL beaker and add a powder packet of active carbon.

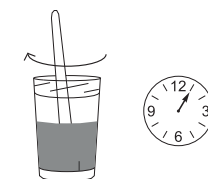

- Mix well using the spoon and then wait for 5 minutes.

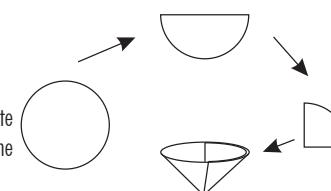

- Fold a filter disc twice as shown in the figure. Separate one side from the other three to form a cone. Insert the folded filter disc in the funnel.

- Filter the treated sample into an empty beaker.

The sample is now ready.

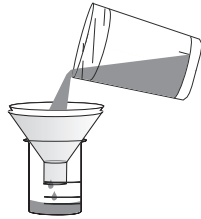

- If the solution is still turbid or colored, treat it again with a packet of active carbon. After use, throw the filter disc away and wash the syringe and the filter assembly well. Always use a new disc for another sample.

CONCENTRATED SAMPLES:

If the analysis result is over the method range, the sample should be diluted. The following procedure describe how to dilute the sample by a factor "N" (that is, to dilute by "N times"):

- Use the graduated cylinder to measure exactly V mL of sample. For volumes $V < 20$ mL, accurately dose the sample by mean of the syringe.

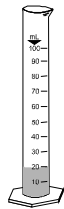

Note: To measure exactly 5 mL of sample with the syringe, push the plunger completely into the syringe and insert the tip into the sample. Pull the plunger out until the lower edge of the seal is on the 5 mL mark of the syringe.

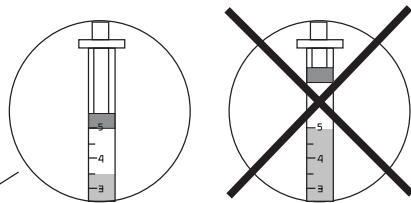

Probable level of liquid taken up by syringe

- Remove the cap and fill the Demineralizer Bottle with tap water.

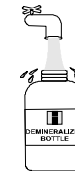

- Replace the cap and shake gently for at least 2 minutes.

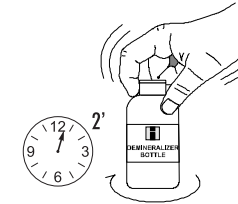

- Open the upper part of the Demineralizer Bottle cap and gently squirt the demineralized water into the cylinder, up to the 100 mL mark.

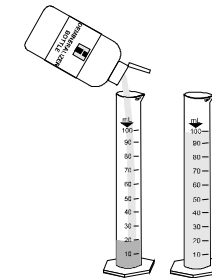

Note: The ion exchange resin contained in the Demineralizer Bottle is provided with an indicator substance. The indicator will change from green to blue when the resin has been exhausted and needs to be replaced.

- Pour the solution in the large 170 mL beaker, replace the cap and invert several times to mix.

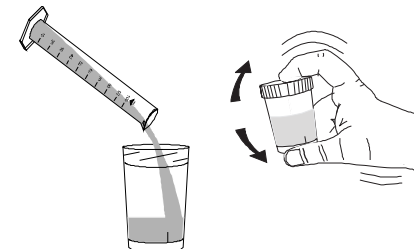

- If the solution contains some turbidity or color, add a powder packet of active carbon and follow the procedure described in previous section **Colored or Turbid Samples**.

- Calculate the dilution factor N:

$$N = 100/V$$

Where:

V is the volume of original sample poured in the cylinder, expressed in mL, and 100 is the final volume in the cylinder, expressed in mL.

- When performing the reading, pay attention to multiply the read value by the dilution factor in order to obtain the real concentration of the analyte in the original sample:

Example:

Reading = value A

Dilution factor = N

Real value in the original sample = A x N

Note: The methods **Potassium Medium Range** and **Potassium High Range** require a dilution of 1:5 (N = 5, V = 20 mL) and 1:10 (N = 10, V = 10 mL) of the sample. As the dilution is always done, it is already included in the final result and is not necessary to multiply by the dilution factor.

ALUMINUM

SPECIFICATIONS

Range 0.00 to 1.00 mg/L

Resolution 0.01 mg/L

Accuracy ± 0.02 mg/L $\pm 4\%$ of reading at 25 °C

Typical EMC ± 0.01 mg/L

Deviation

Light Source Tungsten lamp with narrow band interference filter @ 525 nm

Method Adaptation of the aluminon method. The reaction between aluminum and reagents causes a reddish tint in the sample.

REQUIRED REAGENTS

Code	Description	Quantity
HI 93712A-0	Ascorbic acid	1 packet
HI 93712B-0	Aluminon reagent	1 packet
HI 93712C-0	Bleaching powder	1 packet

REAGENT SETS

HI 93712-01 Reagents for 100 tests

HI 93712-03 Reagents for 300 tests

For other accessories see page 132.

MEASUREMENT PROCEDURE

- Select the *Aluminum* method using the procedure described in the *Method Selection* section (see page 12).
- Fill a graduated beaker with 50 mL of sample.
- Add the content of one packet of HI 93712A-0 Ascorbic acid and mix until completely dissolved.
- Add the content of one packet of HI 93712B-0 Aluminon reagent and mix until completely dissolved. This is the sample.
- Fill two cuvettes with 10 mL of sample each (up to the mark).

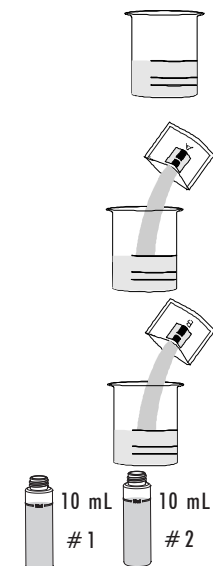

Aluminum

- Add the content of one packet of HI 93712C-0 Bleaching powder to one of the two cuvettes. Replace the cap and shake vigorously until completely dissolved. This is the blank.

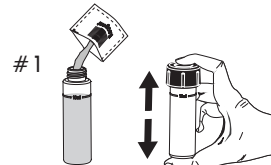

- Place the blank into the holder and close the lid.

- Press **Timer** and the display will show the countdown prior to zeroing the blank. Alternatively wait for 15 minutes and then press **Zero**. The display will show “-0.0-” when the meter is zeroed and ready for measurement.

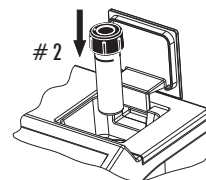
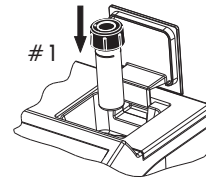
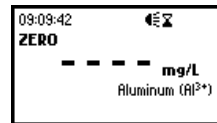
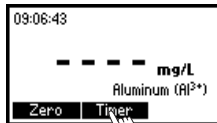

- Remove the blank and insert the other cuvette into the instrument.
- Press the **Read** key and the meter will perform the reading. The instrument displays the results in mg/L of aluminum.

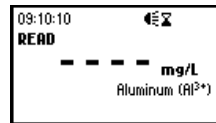

- Press ▲ or ▼ to access the second level functions.
- Press the **Chem Frm** key to convert the result in mg/L of Al₂O₃.

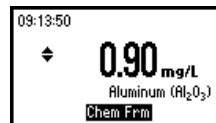
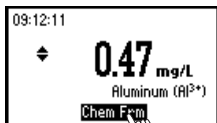

- Press ▲ or ▼ to return to the measurement screen.

INTERFERENCES

Interference may be caused by:

Iron above 20 mg/L, Alkalinity above 1000 mg/L, Phosphate above 50 mg/L; Fluoride must be absent.

ALKALINITY

SPECIFICATIONS

Range	0 to 500 mg/L (as CaCO ₃)
Resolution	5 mg/L
Accuracy	±5 mg/L ±10 % of reading at 25 °C
Typical EMC Deviation	±5 mg/L
Light Source	Tungsten lamp with narrow band interference filter @ 575 nm
Method	Colorimetric Method. The reaction causes a distinctive range of colors from yellow to green to greenish blue to develop.

REQUIRED REAGENTS

Code	Description	Quantity/test
HI 93755-0	Alkalinity Indicator Reagent	1 mL

REAGENT SETS

HI 93755-01 Reagents for 100 tests

HI 93755-03 Reagents for 300 tests

For other accessories see page 132.

MEASUREMENT PROCEDURE

- Select the *Alkalinity* method using the procedure described in the *Method Selection* section (see page 12).
- Fill the cuvette with 10 mL of unreacted sample (up to the mark) and replace the cap.



- Place the cuvette into the holder and close the lid

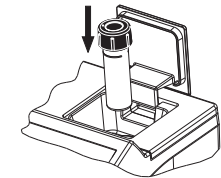

- Press the **Zero** key. The display will show “-0.0-” when the meter is zeroed and ready for measurement.

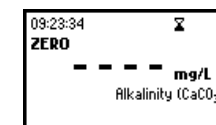
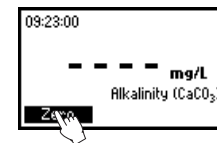

- Remove the cuvette.

Note: Any chlorine present in the sample will interfere with the reading. To remove the chlorine interference add one drop of HI 93755-53 Chlorine Remover to the unreacted sample



- Carefully add exactly 1 mL of HI 93755-0 Liquid Alkalinity Reagent using the supplied syringe.

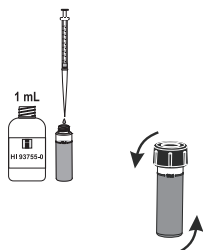

- Replace the cap and invert 5 times.

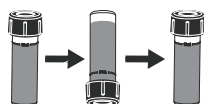

- Reinsert the cuvette into the instrument and close the lid.

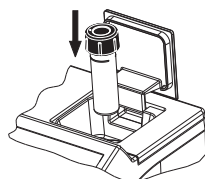

- Press **Read** to start the reading.

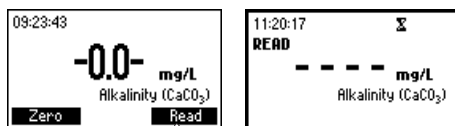

- The instrument displays the results in mg/L of alkalinity (CaCO₃).



Note: If using a meter with software version 1.14 or earlier, readings can be improved for samples with less than 75 ppm alkalinity by adding 0.7 mL of reagent instead of 1.0 mL.

AMMONIA MEDIUM RANGE

SPECIFICATIONS

Range	0.00 to 10.00 mg/L
Resolution	0.01 mg/L
Accuracy	±0.05 mg/L ±5% of reading at 25 °C
Typical EMC Deviation	±0.01 mg/L
Light Source	Tungsten lamp with narrow band interference filter @ 420 nm
Method	Adaptation of the <i>ASTM Manual of Water and Environmental Technology, D1426-92</i> , Nessler method. The reaction between ammonia and reagents causes a yellow tint in the sample.

REQUIRED REAGENTS

Code	Description	Quantity
HI 93715A-0	First Reagent	4 drops (6 drops for seawater)
HI 93715B-0	Second Reagent	4 drops (10 drops for seawater)

REAGENT SETS

HI 93715-01 Reagents for 100 tests
 HI 93715-03 Reagents for 300 tests
 For other accessories see page 132.

MEASUREMENT PROCEDURE

- Select the *Ammonia MR* method using the procedure described in the *Method Selection* section (see page 12).
- Fill the cuvette with 10 mL of unreacted sample (up to the mark) and replace the cap.



- Place the cuvette into the holder and close the lid.

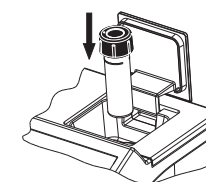

- Press the **Zero** key. The display will show “-0.0-” when the meter is zeroed and ready for measurement.

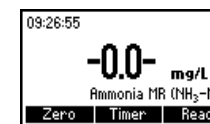
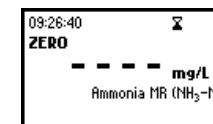
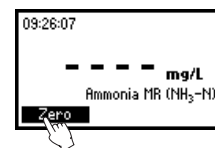

- Remove the cuvette.
- Add 4 drops of HI 93715A-0 First Reagent (6 drops for seawater analysis). Replace the cap and mix the solution.
- Add 4 drops of HI 93715B-0 Second Reagent (10 drops for seawater analysis). Replace the cap and mix the solution.
- Reinsert the cuvette into the instrument.
- Press **Timer** and the display will show the countdown prior to the measurement or, alternatively, wait for 3 minutes and 30 seconds and press **Read**. When the timer ends the meter will perform the reading. The instrument displays the results in **mg/L** of ammonia nitrogen ($\text{NH}_3\text{-N}$).

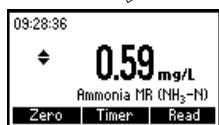
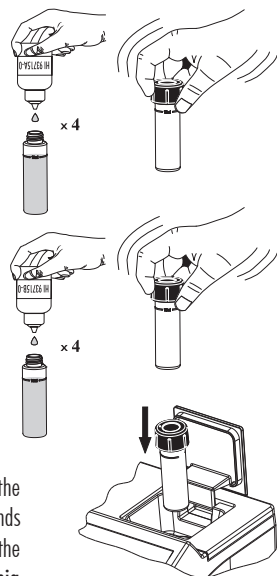

- Press **▲** or **▼** to access the second level functions.
- Press the **Chem Frm** key to convert the result in mg/L of ammonia (NH_3) and ammonium (NH_4^+).

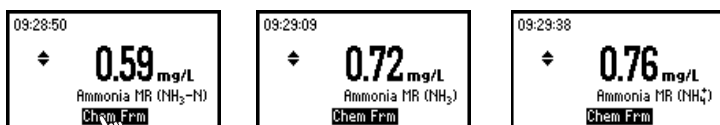

- Press **▲** or **▼** to return to the measurement screen.

INTERFERENCES

Interference may be caused by: acetone, alcohols, aldehydes, glycine, hardness above 1 g/L, iron, organic chloramines, sulfide, various aliphatic and aromatic amines.

AMMONIA LOW RANGE

SPECIFICATIONS

Range	0.00 to 3.00 mg/L
Resolution	0.01 mg/L
Accuracy	± 0.04 mg/L $\pm 4\%$ of reading at 25 °C
Typical EMC Deviation	± 0.01 mg/L
Light Source	Tungsten lamp with narrow band interference filter @ 420 nm
Method	Adaptation of the <i>ASTM Manual of Water and Environmental Technology, D1426-92</i> , Nessler method. The reaction between ammonia and reagents causes a yellow tint in the sample.

REQUIRED REAGENTS

Code	Description	Quantity
HI 93700A-0	First Reagent	4 drops (6 drops for seawater)
HI 93700B-0	Second Reagent	4 drops (10 drops for seawater)

REAGENT SETS

HI 93700-01 Reagents for 100 tests
 HI 93700-03 Reagents for 300 tests
 For other accessories see page 132.

MEASUREMENT PROCEDURE

- Select the *Ammonia LR* method using the procedure described in the *Method Selection* section (see page 12).
- Fill the cuvette with 10 mL of unreacted sample (up to the mark) and replace the cap.
- Place the cuvette into the holder and close the lid.

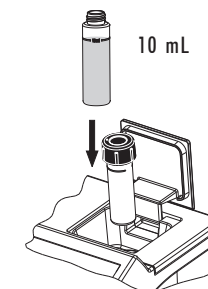

- Press the **Zero** key. The display will show "-0.0-" when the meter is zeroed and ready for measurement.

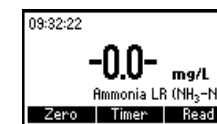
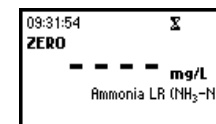
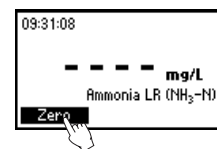

- Remove the cuvette.
- Add 4 drops of HI 93700A-0 First Reagent (6 drops for seawater analysis). Replace the cap and mix the solution.
- Add 4 drops of HI 93700B-0 Second Reagent (10 drops for seawater analysis). Replace the cap and mix the solution.
- Reinsert the cuvette into the instrument.

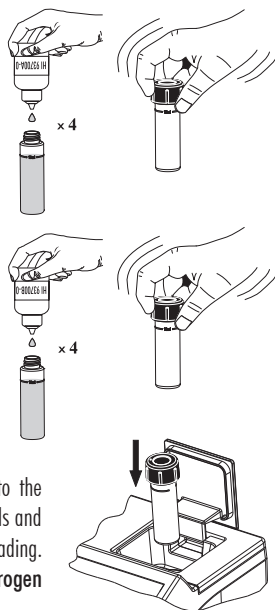

- Press **Timer** and the display will show the countdown prior to the measurement or, alternatively, wait for 3 minutes and 30 seconds and press **Read**. When the timer ends the meter will perform the reading. The instrument displays the results in **mg/L of ammonia nitrogen (NH₃-N)**.

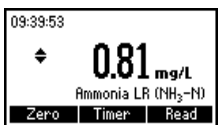
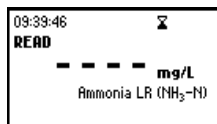
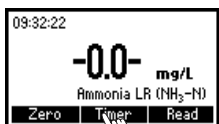

- Press **▲** or **▼** to access the second level functions.
- Press the **Chem Frm** key to convert the result in mg/L of ammonia (NH₃) and ammonium (NH₄⁺).

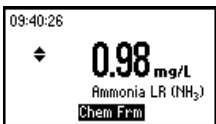
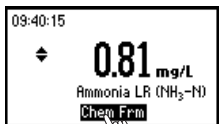

- Press **▲** or **▼** to return to the measurement screen.

INTERFERENCES

Interference may be caused by: acetone, alcohols, aldehydes, glycine, hardness above 1 g/L, iron, organic chloramines, sulfide, various aliphatic and aromatic amines.

BROMINE

SPECIFICATIONS

Range	0.00 to 8.00 mg/L
Resolution	0.01 mg/L
Accuracy	±0.08 mg/L ±3% of reading at 25 °C
Typical EMC Deviation	±0.01 mg/L
Light Source	Tungsten lamp with narrow band interference filter @ 525 nm
Method	Adaptation of the <i>Standard Methods for the Examination of Water and Wastewater, 18th edition</i> , DPD method. The reaction between bromine and the reagent causes a pink tint in the sample.

REQUIRED REAGENTS

Code	Description	Quantity
HI 93716-0	DPD Reagent	1 packet

REAGENT SETS

HI 93716-01 Reagents for 100 tests

HI 93716-03 Reagents for 300 tests

For other accessories see page 132.

MEASUREMENT PROCEDURE

- Select the *Bromine* method using the procedure described in the *Method Selection* section (see page 12).

- Fill the cuvette with 10 mL of unreacted sample (up to the mark) and replace the cap.



- Place the cuvette into the holder and close the lid.

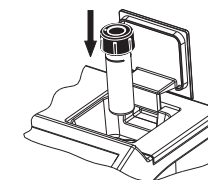

- Press the **Zero** key. The display will show “-0.0-” when the meter is zeroed and ready for measurement.

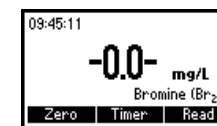
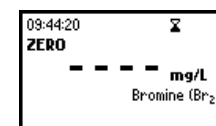
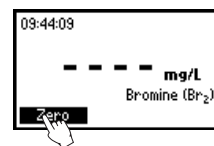

- Remove the cuvette and add the content of one packet of HI 93716-0 DPD reagent. Replace the cap and shake gently for about 20 seconds to dissolve most of the reagent.

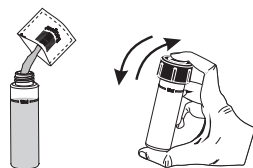

- Reinsert the cuvette into the instrument.

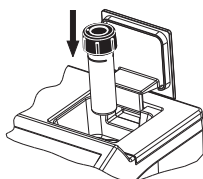

- Press **Timer** and the display will show the countdown prior to the measurement or, alternatively, wait for 2 minutes and 30 seconds and press **Read**. When the timer ends the meter will perform the reading.

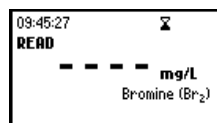
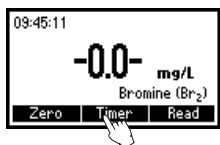

- The instrument displays the results in **mg/L of bromine**.

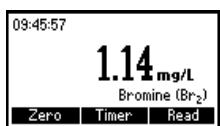

INTERFERENCES

Interference may be caused by: Chlorine, Iodine, Ozone, Oxidized forms of Chromium and Manganese. In case of water with hardness greater than 500 mg/L CaCO₃, shake the sample for approximately 2 minutes after adding the reagent. In case of water with alkalinity greater than 250 mg/L CaCO₃ or acidity greater than 150 mg/L CaCO₃, the color of the sample may develop only partially, or may rapidly fade. To resolve this, neutralize the sample with diluted HCl or NaOH.

CALCIUM

SPECIFICATIONS

Range	0 to 400 mg/L
Resolution	10 mg/L
Accuracy	±10 mg/L ±5% of reading at 25 °C
Light Source	Tungsten lamp with narrow band interference filter @ 466 nm
Method	Adaptation of the Oxalate method.

REQUIRED REAGENTS

Code	Description	Quantity
-	Buffer Reagent	4 drops
HI 93752A-0 Ca	Calcium Buffer Reagent	7 mL
HI 93752B-0 Ca	Calcium Oxalate Reagent	1 mL

REAGENT SETS

HI 937521-01	Reagents for 50 tests
HI 937521-03	Reagents for 150 tests

For other accessories see page 132.

MEASUREMENT PROCEDURE

Note: for sample preparation follow the COLORED OR TURBID SAMPLES procedure at page 17.

- Select the *Calcium* method using the procedure described in the *Method Selection* section (see page 12).
- Using the 5 mL syringe add exactly 3.00 mL of sample to the cuvette.

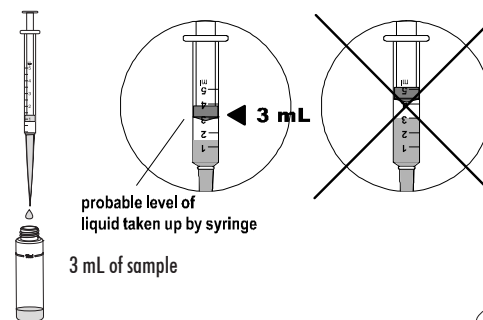

- Use the pipette to fill the cuvette up to the 10 mL mark with the HI 93752A-0 Calcium Buffer Reagent.

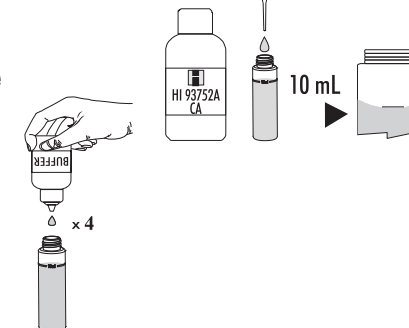

- Add 4 drops of Buffer Reagent.

FREE CHLORINE

- Replace the cap and invert several times to mix.
- Place the cuvette into the holder and close the lid.

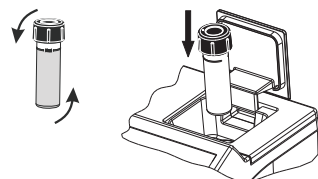

- Press the **Zero** key. The display will show “-0.0-” when the meter is zeroed and ready for measurement.

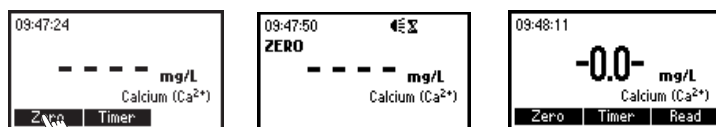

- Remove the cuvette.
- Using the 1 mL syringe, add exactly 1 mL of the HI 93752B-0 Calcium Oxalate Reagent. Replace the cap and invert the cuvette 10 times to mix (about 15 seconds).
- Press **Timer** or wait for 5 minutes. Then invert again the cuvette 10 times to mix (about 15 seconds).

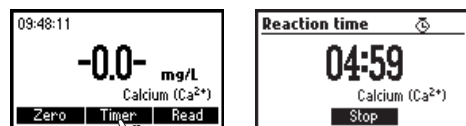
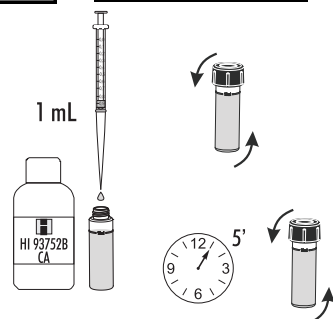

- Reinsert the cuvette into the instrument.
- Press **Read** to start the reading. The instrument displays the results in mg/L of Calcium.

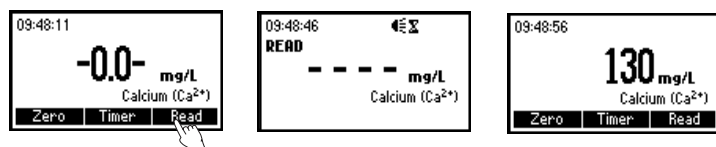

INTERFERENCES:

Interferences may be caused by:

- Acidity (as CaCO₃) above 1000 mg/L
- Alkalinity (as CaCO₃) above 1000 mg/L
- Magnesium (Mg²⁺) above 400 mg/L

SPECIFICATIONS

Range	0.00 to 2.50 mg/L
Resolution	0.01 mg/L
Accuracy	±0.03 mg/L ±3% of reading at 25 °C
Typical EMC Deviation	±0.01 mg/L
Light Source	Tungsten lamp with narrow band interference filter @ 525 nm
Method	Adaptation of the <i>EPA DPD method 330.5</i> . The reaction between free chlorine and the DPD reagent causes a pink tint in the sample.

REQUIRED REAGENTS

POWDER:

Code	Description	Quantity
HI 93701-0	DPD	1 packet

LIQUID:

Code	Description	Quantity
HI 93701A-F	DPD1 Indicator	3 drops
HI 93701B-F	DPD1 Buffer	3 drops

REAGENT SETS

- HI 93701-F Reagents for 300 tests (liquid)
 - HI 93701-01 Reagents for 100 tests (powder)
 - HI 93701-03 Reagents for 300 tests (powder)
- For other accessories see page 132.

MEASUREMENT PROCEDURE

- Select the *Free Chlorine* method using the procedure described in the *Method Selection* section (see page 12).
- Fill the cuvette with 10 mL of unreacted sample (up to the mark) and replace the cap.
- Place the cuvette into the holder and close the lid.

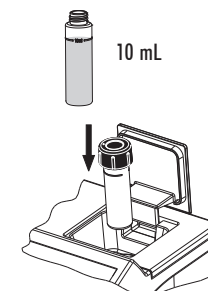

- Press the **Zero** key. The meter will show “-0.0-” when the meter is zeroed and ready for measurement.



- Remove the cuvette.

Powder reagents procedure

- Add the content of one packet of HI 93701 DPD reagent. Replace the cap and shake gently for 20 seconds (or 2 minutes for seawater analysis).

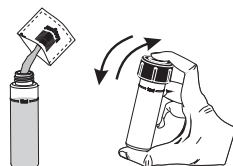

- Reinsert the cuvette into the instrument.

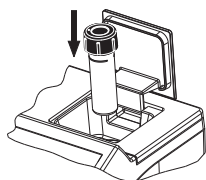

- Press **Timer** and the display will show the countdown prior to the measurement or, alternatively, wait for 1 minute and press **Read**. When the timer ends the meter will perform the reading. The instrument displays the results in **mg/L of free chlorine**.



Liquid reagents procedure

- To an empty cuvette add 3 drops of HI 93701A-F DPD1 indicator and 3 drops of HI 93701B-F DPD1 buffer. Swirl gently to mix, and immediately add 10 mL of unreacted sample. Replace the cap and shake gently again.

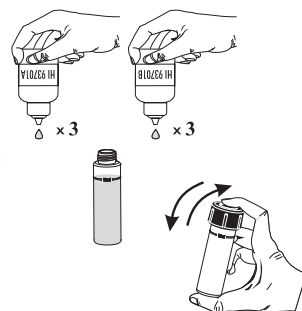

- Place the cuvette into the instrument.

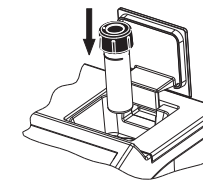

- Press **Read** to start the reading. The instrument displays the results in **mg/L of free chlorine**.

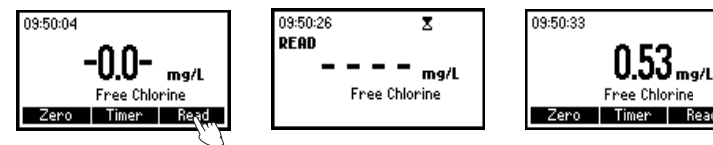

INTERFERENCES

Interference may be caused by: Bromine, Iodine, Ozone, Oxidized forms of Chromium and Manganese.

In case of water with hardness greater than 500 mg/L CaCO₃, shake the sample for approximately 2 minutes after adding the powder reagent.

In case of water with alkalinity greater than 250 mg/L CaCO₃ or acidity greater than 150 mg/L CaCO₃, the color of the sample may develop only partially, or may rapidly fade. To resolve this, neutralize the sample with diluted HCl or NaOH.

TOTAL CHLORINE

SPECIFICATIONS

Range	0.00 to 3.50 mg/L
Resolution	0.01 mg/L
Accuracy	±0.03 mg/L ±3% of reading at 25 °C
Typical EMC	±0.01 mg/L
Deviation	
Light Source	Tungsten lamp with narrow band interference filter @ 525 nm
Method	Adaptation of the <i>EPA DPD method 330.5</i> . The reaction between the chlorine and the DPD reagent causes a pink tint in the sample.

REQUIRED REAGENTS

POWDER:

Code	Description	Quantity
HI 93711-0	DPD	1 packet

LIQUID:

Code	Description	Quantity
HI 93701A-T	DPD1 indicator	3 drops
HI 93701B-T	DPD1 buffer	3 drops
HI 93701C	DPD3 solution	1 drop

REAGENT SETS

- HI 93701-T Reagents for 300 total chlorine tests (liquid)
 - HI 93711-01 Reagents for 100 total chlorine tests (powder)
 - HI 93711-03 Reagents for 300 total chlorine tests (powder)
- For other accessories see page 132.

MEASUREMENT PROCEDURE

- Select the *Total Chlorine* method using the procedure described in the *Method Selection* section (see page 12).
- Fill the cuvette with 10 mL of unreacted sample (up to the mark) and replace the cap.
- Place the cuvette into the holder and close the lid.

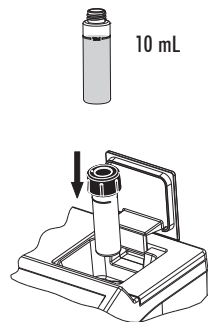

- Press the **Zero** key. The meter will show “-0.0-” when the meter is zeroed and ready for measurement.

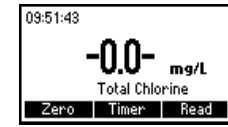
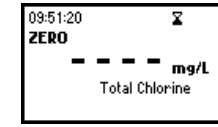
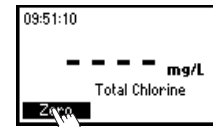

- Remove the cuvette.

Powder reagents procedure

- Add 1 packet of HI 93711 DPD reagent. Replace the cap and shake gently for 20 seconds (or 2 minutes for seawater analysis).
- Reinsert the cuvette into the instrument.
- Press **Timer** and the display will show the countdown prior to the measurement or, alternatively, wait for 2 minutes and 30 seconds and press **Read**. When the timer ends the meter will perform the reading. The instrument displays the results in **mg/L** of total chlorine.

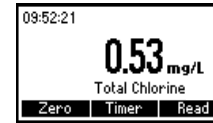
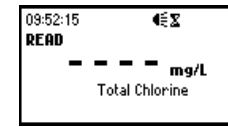
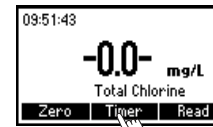
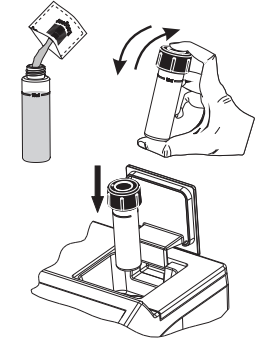

Liquid reagents procedure

- To an empty cuvette add 3 drops of HI 93701A-T DPD1 indicator, 3 drops of HI 93701B-T DPD1 buffer and 1 drop of HI 93701C DPD3 solution. Swirl gently to mix and immediately add 10 mL of unreacted sample. Replace the cap and shake gently again.
- Reinsert the cuvette into the instrument.

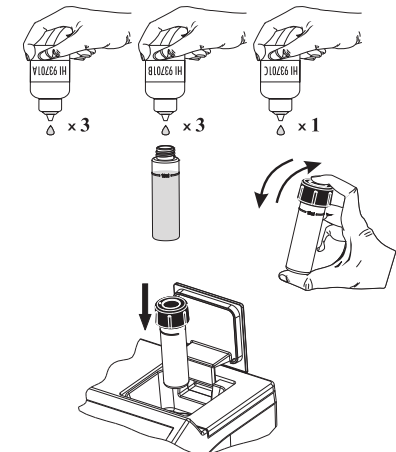

- Press **Timer** and the display will show the countdown prior to the measurement or, alternatively, wait for 2 minutes and 30 seconds and press **Read**. When the timer ends the meter will perform the reading.



- The instrument displays the results in **mg/L** of total chlorine.

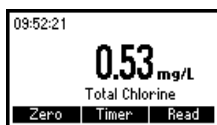

Note: free and total chlorine have to be measured separately with fresh unreacted samples following the related procedure if both values are requested.

INTERFERENCES

Interference may be caused by: Bromine, Iodine, Ozone, Oxidized forms of Chromium and Manganese.

In case of water with hardness greater than 500 mg/L CaCO₃, shake the sample for approximately 2 minutes after adding the powder reagent.

In case of water with alkalinity greater than 250 mg/L CaCO₃ or acidity greater than 150 mg/L CaCO₃, the color of the sample may develop only partially, or may rapidly fade. To resolve this, neutralize the sample with diluted HCl or NaOH.

CHLORINE DIOXIDE

SPECIFICATIONS

Range	0.00 to 2.00 mg/L
Resolution	0.01 mg/L
Accuracy	±0.10 mg/L ±5% of reading at 25 °C
Typical EMC	±0.01 mg/L
Deviation	
Light Source	Tungsten lamp with narrow band interference filter @ 575 nm
Method	Adaptation of the Chlorophenol Red method. The reaction between chlorine dioxide and reagents causes a colorless to purple tint in the sample.

REQUIRED REAGENT

Code	Description	Quantity
HI 93738A-0	Reagent A	1 mL
HI 93738B-0	Dechlorinating Reagent B	1 packet
HI 93738C-0	Reagent C	1 mL
HI 93738D-0	Reagent D	1 mL

REAGENT SETS

HI 93738-01 Reagents for 100 tests

HI 93738-03 Reagents for 300 tests

For other accessories see page 132.

MEASUREMENT PROCEDURE

- Select the *Chlorine Dioxide* method using the procedure described in the *Method Selection* section (see page 12).
- Fill two graduated mixing cylinders (# 1 & # 2) up to the 25 mL mark with the sample.

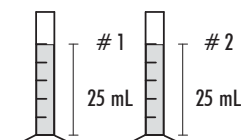

- Add 0.5 mL of HI 93738A-0 Chlorine Dioxide Reagent to each cylinder (# 1 & # 2), close them and invert several times to mix.

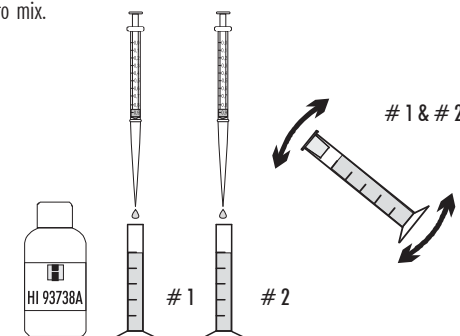

- Add the content of one packet of HI 93738B-0 Dechlorinating Reagent to one of the two cylinders (# 1), close and invert it several times until it is totally dissolved. This is the blank.

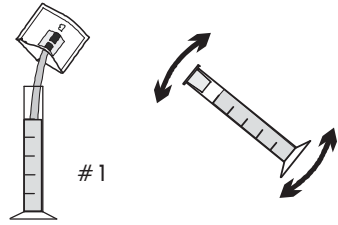

- Add precisely 0.5 mL of HI 93738C-0 Chlorine Dioxide Reagent to each cylinder (# 1 & # 2), close them and invert several times to mix.

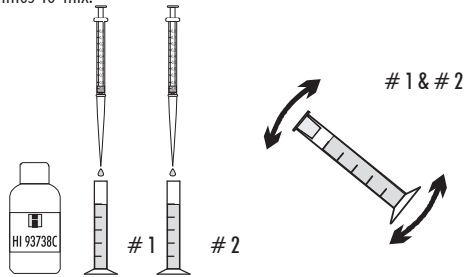

- Add 0.5 mL of HI 93738D-0 Chlorine Dioxide Reagent to each cylinder (# 1 & # 2), close them and invert several times to mix. Cylinder # 2 is the reacted sample.

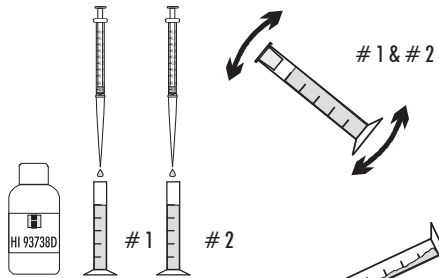

- Fill a cuvette with 10 mL of the blank (# 1) up to the mark and replace the cap.

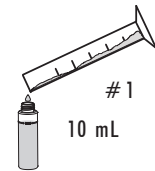

- Place the blank (# 1) into the holder and close the lid.

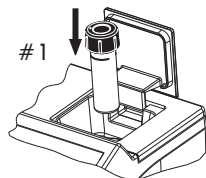

- Press the **Zero** key. The meter will show “-0.0-” when the meter is zeroed and ready for measurement.

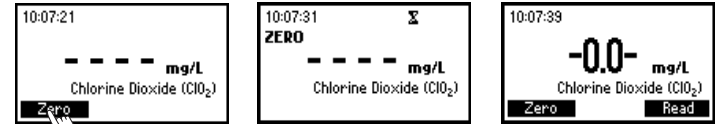

- Fill another cuvette with 10 mL of the reacted sample (# 2) up to the mark and replace the cap.

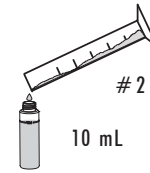

- Insert the sample into the instrument.

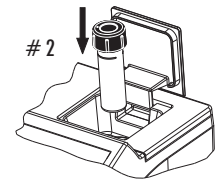

- Press **Read** and the meter will perform the reading. The instrument displays the results in **mg/L of chlorine dioxide**.

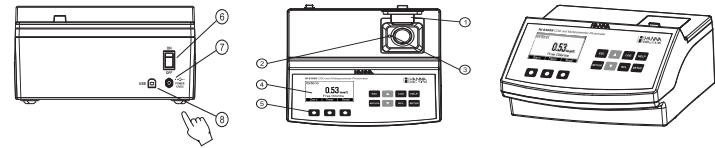

SAMPLING PROCEDURE

It is recommended to analyze chlorine dioxide samples immediately after collection. Chlorine dioxide samples must be stored in sealed dark glass bottle, with minimal head space. Excessive heat (above 25°C/78°F), agitation and exposure to light must be avoided.

INTERFERENCES

Interferences may be caused by strong oxidants.

CHROMIUM VI HIGH RANGE

SPECIFICATIONS

Range	0 to 1000 µg/L
Resolution	1 µg/L
Accuracy	±5 µg/L ±4% of reading at 25 °C
Typical EMC Deviation	±1 µg/L
Light Source	Tungsten lamp with narrow band interference filter @ 525 nm
Method	Adaptation of the <i>ASTM Manual of Water and Environmental Technology, D1687-92</i> , Diphenylcarbohydrazide method. The reaction between chromium VI and the reagent causes a purple tint in the sample.

REQUIRED REAGENTS

Code	Description	Quantity
HI 93723-0	Powder reagent	1 packet

REAGENT SETS

HI 93723-01 Reagents for 100 tests

HI 93723-03 Reagents for 300 tests

For other accessories see page 132.

MEASUREMENT PROCEDURE

- Select the *Chromium VI HR* method using the procedure described in the *Method Selection* section (see page 12).
- Fill the cuvette with 10 mL of unreacted sample (up to the mark) and replace the cap.
- Place the cuvette into the holder and close the lid.

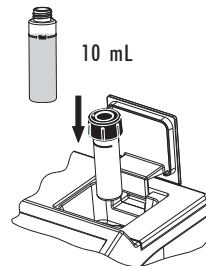

- Press the **Zero** key. The meter will show “-0.0-” when the meter is zeroed and ready for measurement.

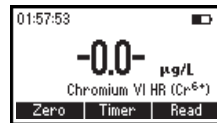
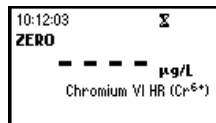

- Remove the cuvette and add the content of one packet of HI 93723-0 reagent. Replace the cap and shake vigorously for about 10 seconds.

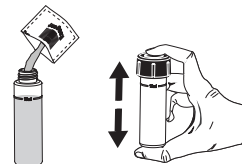

- Reinsert the cuvette into the instrument.

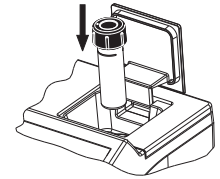

- Press **Timer** and the display will show the countdown prior to the measurement or, alternatively, wait for 6 minutes and press **Read**. When the timer ends the meter will perform the reading. The instrument displays concentration in µg/L of chromium VI.

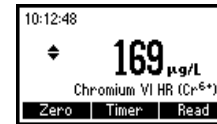
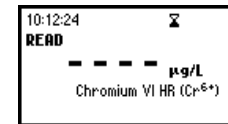
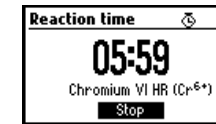
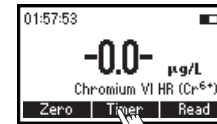

- Press ▲ or ▼ to access the second level functions.
- Press the **Chem Frm** key to convert the result in µg/L of Chromate (CrO_4^{2-}) and Dichromate ($\text{Cr}_2\text{O}_7^{2-}$).

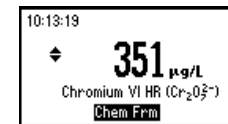
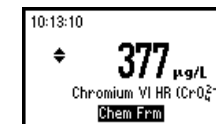
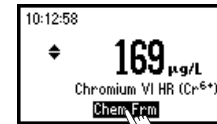

- Press ▲ or ▼ to return to the measurement screen.

INTERFERENCES

Interference may be caused by:

Vanadium above 1 ppm. However, waiting 10 minutes before reading, the interference is removed

Iron above 1 ppm

Mercurous and mercuric ions cause slight inhibition of the reaction.

CHROMIUM VI LOW RANGE

SPECIFICATIONS

Range	0 to 300 µg/L
Resolution	1 µg/L
Accuracy	±1 µg/L ±4% of reading at 25 °C
Typical EMC Deviation	±1 µg/L
Light Source	Tungsten lamp with narrow band interference filter @ 525 nm
Method	Adaptation of the <i>ASTM Manual of Water and Environmental Technology, D1687-92</i> , Diphenylcarbohydrazide method. The reaction between chromium VI and the reagent causes a purple tint in the sample.

REQUIRED REAGENTS

Code	Description	Quantity
HI 93749-0	Powder reagent	1 packet

REAGENT SETS

HI 93749-01 Reagents for 100 tests

HI 93749-03 Reagents for 300 tests

For other accessories see page 132.

MEASUREMENT PROCEDURE

- Select the *Chromium VI LR* method using the procedure described in the *Method Selection* section (see page 12).
- Fill the cuvette with 10 mL of unreacted sample (up to the mark) and replace the cap.
- Place the cuvette into the holder and close the lid.
- Press the **Zero** key. The meter will show “-0.0-” when the meter is zeroed and ready for measurement.

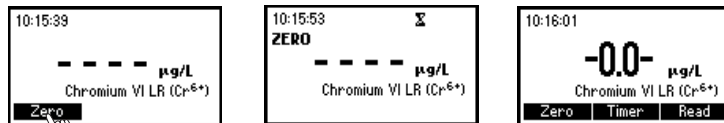
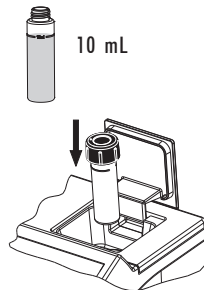

- Remove the cuvette and add the content of one packet of HI 93749-0 reagent. Replace the cap and shake vigorously for about 10 seconds.

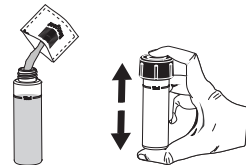

- Reinsert the cuvette into the instrument.

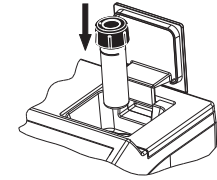

- Press **Timer** and the display will show the countdown prior to the measurement or, alternatively, wait for 6 minutes and press **Read**. When the timer ends the meter will perform the reading. The instrument displays concentration in µg/L of chromium VI.

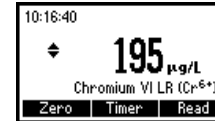

- Press ▲ or ▼ to access the second level functions.
- Press the **Chem Frm** key to convert the result in µg/L of Chromate (CrO_4^{2-}) and Dichromate ($\text{Cr}_2\text{O}_7^{2-}$).

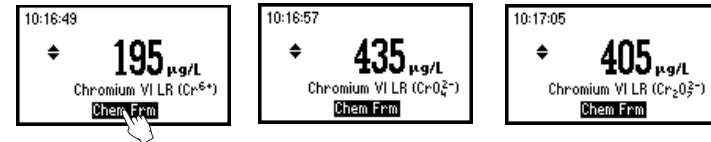

- Press ▲ or ▼ to return to the measurement screen.

INTERFERENCES

Interference may be caused by:

Vanadium above 1 ppm. However, waiting 10 minutes before reading, the interference is removed.

Iron above 1 ppm

Mercurous and mercuric ions cause slight inhibition of the reaction.

COLOR OF WATER

SPECIFICATIONS

Range	0 to 500 PCU (Platinum Cobalt Units)
Resolution	1 PCU
Accuracy	±10 PCU ±5% of reading at 25 °C
Typical EMC Deviation	± 1 PCU
Light Source	Tungsten lamp with narrow band interference filter @ 420 nm
Method	Adaptation of the <i>Standard Methods for the Examination of Water and Wastewater, 18th edition</i> , Colorimetric Platinum Cobalt method.

REQUIRED ACCESSORIES

0.45 µm membrane for true color measurement.
For other accessories see page 132.

MEASUREMENT PROCEDURE

- Select the *Color of Water* method using the procedure described in the *Method Selection* section (see page 12).

- Fill one cuvette up to the mark with deionized water and replace the cap. This is the blank.
- Place the blank (# 1) into the holder and close the lid.

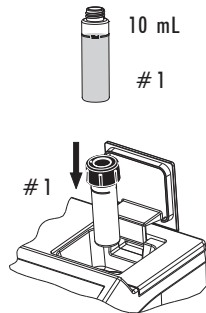

- Press the **Zero** key. The meter will show “-0.0-” when the meter is zeroed and ready for measurement.

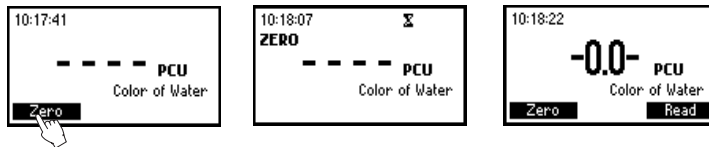

- Remove the blank.

- Fill the second cuvette up to the mark with unfiltered sample and replace the cap. This is the apparent color.
- Filter 10 mL of sample through a filter with a 0.45 µm membrane into the third cuvette, up to the 10 mL mark and replace the cap. This is the true color.

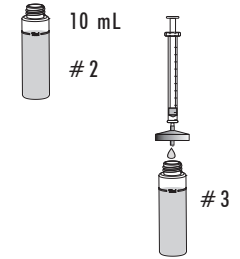

- Insert the apparent color cuvette (# 2) into the instrument and close the lid.
- Press **Read** to start the reading.
- The meter displays the value of **apparent color** in PCU.

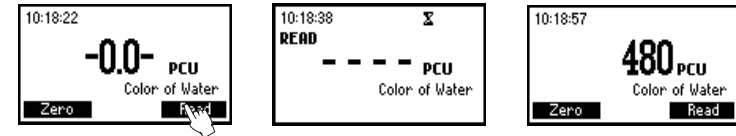
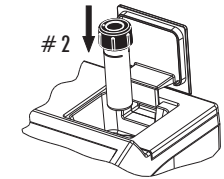

- Remove the cuvette, insert the true color cuvette (# 3) into the instrument and ensure that the notch on the cap is positioned securely into the groove.
- Press **Read** to start the reading. The meter displays the value of **true color** in PCU.

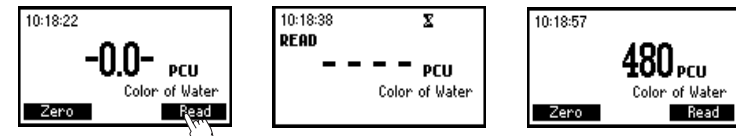
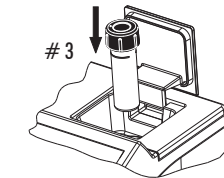

COPPER HIGH RANGE

SPECIFICATIONS

Range	0.00 to 5.00 mg/L
Resolution	0.01 mg/L
Accuracy	± 0.02 mg/L $\pm 4\%$ of reading at 25 °C
Typical EMC Deviation	± 0.01 mg/L
Light Source	Tungsten lamp with narrow band interference filter @ 575 nm
Method	Adaptation of the <i>EPA method</i> . The reaction between copper and the bicinchoninate reagent causes a purple tint in the sample.

REQUIRED REAGENTS

Code	Description	Quantity
HI 93702-0	Bicinchoninate	1 packet

REAGENT SETS

HI 93702-01 Reagents for 100 tests

HI 93702-03 Reagents for 300 tests

For other accessories see page 132.

MEASUREMENT PROCEDURE

- Select the *Copper HR* method using the procedure described in the *Method Selection* section (see page 12).
- Fill the cuvette with 10 mL of unreacted sample (up to the mark) and replace the cap.

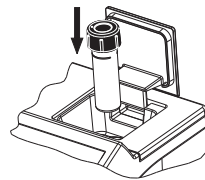

- Place the cuvette into the holder and close the lid.

- Press the **Zero** key. The meter will show “-0.0-” when the meter is zeroed and ready for measurement.

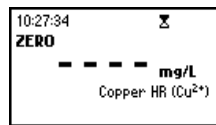
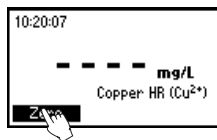

- Remove the cuvette.
- Add the content of one packet of HI 93702-0 Bicinchoninate. Replace the cap and shake gently for about 15 seconds.

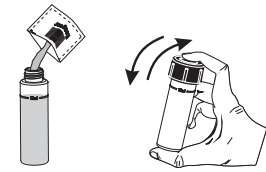

- Reinsert the cuvette into the instrument.

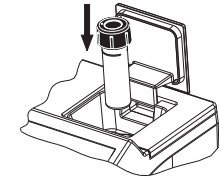

- Press **Timer** and the display will show the countdown prior to the measurement or, alternatively, wait for 45 seconds and press **Read**. When the timer ends the meter will perform the reading.

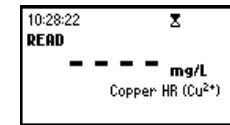
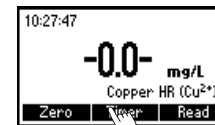

- The instrument displays the results in **mg/L** of copper.



INTERFERENCES

Interference may be caused by:

Silver
Cyanide

For samples overcoming buffering capacity of reagent (around pH 6.8), pH should be adjusted between 6 and 8.

COPPER LOW RANGE

SPECIFICATIONS

Range	0 to 1000 µg/L
Resolution	1 µg/L
Accuracy	±10 µg/L ±5% of reading at 25 °C
Typical EMC Deviation	±1 µg/L
Light Source	Tungsten lamp with narrow band interference filter @ 575 nm
Method	Adaptation of the <i>EPA method</i> . The reaction between copper and the bicinchoninate reagent causes a purple tint in the sample.

REQUIRED REAGENTS

Code	Description	Quantity
HI 95747-0	Bicinchoninate	1 packet

REAGENT SETS

HI 95747-01 Reagents for 100 tests

HI 95747-03 Reagents for 300 tests

For other accessories see page 132.

MEASUREMENT PROCEDURE

- Select the *Copper LR* method using the procedure described in the *Method Selection* section (see page 12).
- Fill the cuvette with 10 mL of unreacted sample (up to the mark) and replace the cap.

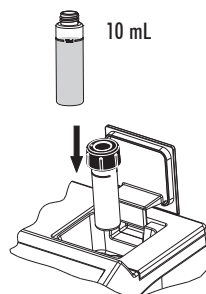

- Place the cuvette into the holder and close the lid.

- Press the **Zero** key. The meter will show “-0.0-” when the meter is zeroed and ready for measurement.

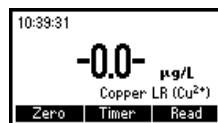
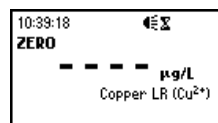
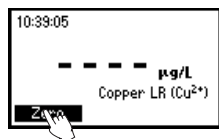

- Remove the cuvette.
- Add the content of one packet of HI 95747-0 Bicinchoninate. Replace the cap and shake gently for about 15 seconds.

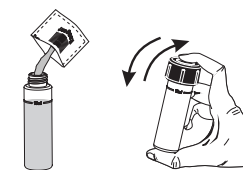

- Reinsert the cuvette into the instrument.

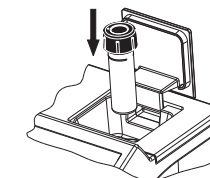

- Press **Timer** and the display will show the countdown prior to the measurement or, alternatively, wait for 45 seconds and press **Read**. When the timer ends the meter will perform the reading.

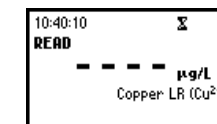
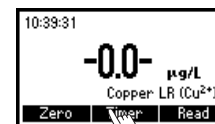

- The instrument displays the results in µg/L of copper.

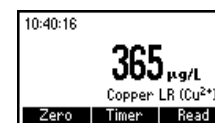

INTERFERENCES

Interference may be caused by:

Silver
Cyanide

For samples overcoming buffering capacity of reagent (around pH 6.8), pH should be adjusted between 6 and 8.

CYANURIC ACID

SPECIFICATIONS

Range	0 to 80 mg/L
Resolution	1 mg/L
Accuracy	±1 mg/L ±15% of reading at 25 °C
Typical EMC Deviation	±1 mg/L
Light Source	Tungsten lamp with narrow band interference filter @ 525 nm
Method	Adaptation of the turbidimetric method. The reaction between cyanuric acid and the reagent causes a white suspension in the sample.

REQUIRED REAGENTS

Code	Description	Quantity
HI 93722-0	Powder reagent	1 packet

REAGENT SETS

HI 93722-01 Reagents for 100 tests
 HI 93722-03 Reagents for 300 tests
 For other accessories see page 132.

MEASUREMENT PROCEDURE

- Select the *Cyanuric Acid* method using the procedure described in the *Method Selection* section (see page 12).
- Fill the cuvette with 10 mL of unreacted sample (up to the mark) and replace the cap.

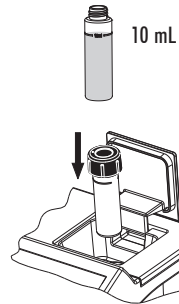

- Place the cuvette into the holder and close the lid.

- Press the **Zero** key. The meter will show “-0.0-” when the meter is zeroed and ready for measurement.

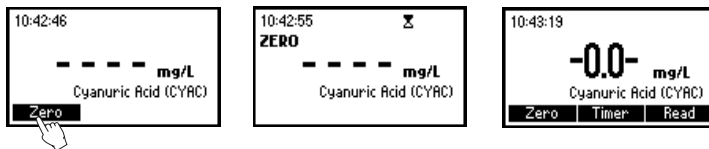

- Add the content of one packet of HI 93722-0 Cyanuric Acid Reagent. Replace the cap and shake gently for about 10 seconds (dissolution is not complete).

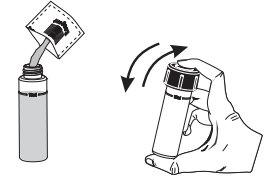

- Reinsert the cuvette into the instrument.

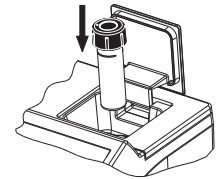

- Press **Timer** and the display will show the countdown prior to the measurement or, alternatively, wait for 45 seconds and press **Read**. When the timer ends the meter will perform the reading.

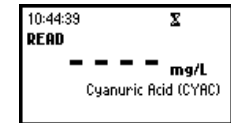
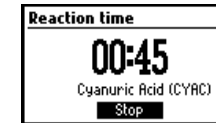
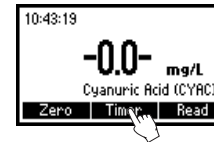

- The instrument displays concentration in **mg/L** of cyanuric acid.

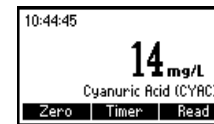

FLUORIDE

SPECIFICATIONS

Range	0.00 to 2.00 mg/L
Resolution	0.01 mg/L
Accuracy	±0.03 mg/L ±3% of reading at 25 °C
Typical EMC Deviation	±0.01 mg/L
Light Source	Tungsten lamp with narrow band interference filter @ 575 nm
Method	Adaptation of the <i>Standard Methods for the Examination of Water and Wastewater, 18th edition</i> , SPADNS method. The reaction between fluoride and the liquid reagent causes a red tint in the sample.

REQUIRED REAGENT

Code	Description	Quantity
HI 93729-0	SPADNS Reagent	4 mL

REAGENT SETS

HI 93729-01 Reagents for 100 tests

HI 93729-03 Reagents for 300 tests

For other accessories see page 132.

MEASUREMENT PROCEDURE

- Select the *Fluoride* method using the procedure described in the *Method Selection* section (see page 12).
- Add 2 mL of HI 93729-0 SPADNS Reagent to two cuvettes.
- Fill one of the cuvettes with distilled water up to the mark, replace the cap and invert several times to mix.
- Fill the other cuvette with sample up to the mark, replace the cap and invert several times to mix.
- Place the cuvette with the reacted distilled water (# 1) into the holder and close the lid.

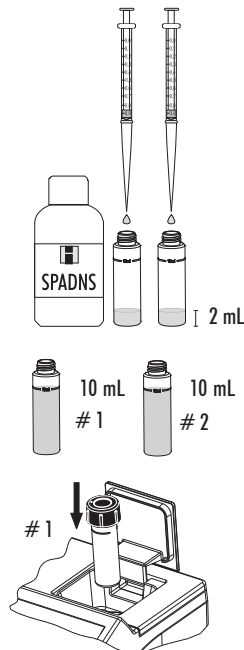

- Press **Timer** and the display will show the countdown prior to zeroing the blank or, alternatively, wait for two minutes and press **Zero**. The display will show “-0.0-” when the meter is zeroed and ready for measurement.

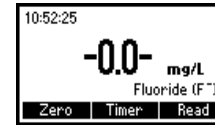
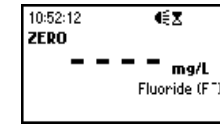
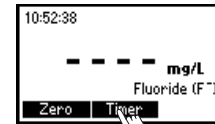

- Remove the cuvette.
- Insert the other cuvette (# 2) with the reacted sample into the instrument.
- Press **Read** to start reading. The instrument displays the results in mg/L of fluoride.

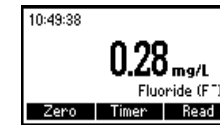
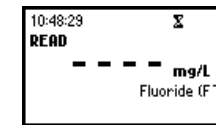
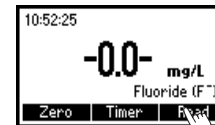
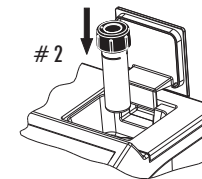

Note: For wastewater or seawater samples, before performing measurements, distillation is required. For most accurate results, use two graduated pipettes to deliver exactly 8 mL of distilled water and 8 mL of sample.

INTERFERENCES

Interferences may be caused by:

- Alkalinity (as CaCO₃) above 5000 mg/L
- Aluminum above 0.1 mg/L
- Iron, ferric above 10 mg/L
- Chloride above 700 mg/L
- Phosphate, ortho above 16 mg/L
- Sodium hexametaphosphate above 1.0 mg/L
- Sulfate above 200 mg/L

Highly colored and turbid samples may require distillation
Highly alkaline samples can be neutralized with nitric acid.

CALCIUM HARDNESS

SPECIFICATIONS

Range	0.00 to 2.70 mg/L	
Resolution	0.01 mg/L	
Accuracy	±0.11 mg/L ±5% of reading at 25 °C	
Typical EMC	±0.01 mg/L	
Deviation		
Light Source	Tungsten lamp with narrow band interference filter @ 525 nm	
Method	Adaptation of the <i>Standard Methods for the Examination of Water and Wastewater, 18th edition</i> , Calmagite method. The reaction between calcium and reagents causes a reddish-violet tint in the sample.	

REQUIRED REAGENTS

Code	Description	Quantity
HI 93720A-0	Ca & Mg indicator	0.5 mL
HI 93720B-0	Alkali solution	0.5 mL
HI 93720C-0	EGTA solution	1 drop

REAGENT SETS

HI 93720-01 Reagents for 100 tests
 HI 93720-03 Reagents for 300 tests
 For other accessories see page 132.

MEASUREMENT PROCEDURE

- Select the *Calcium Hardness* method using the procedure described in the *Method Selection* section (see page 12).

- Rinse a graduated beaker several times with unreacted sample, before filling it to the 50 mL mark with the sample.

- Add 0.5 mL of HI 93720A-0 Calcium indicator solution and swirl to mix.

- Add 0.5 mL of HI 93720B-0 Alkali solution and swirl to mix. Use this solution to rinse 2 cuvettes before filling them up to the 10 mL mark.

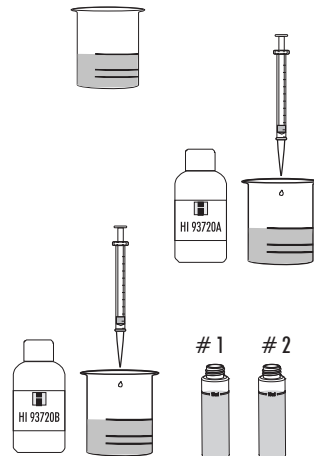

- Add 1 drop of HI 93720C-0 EGTA solution to one cuvette (# 1), replace the cap and invert the cuvette several times to mix. This is the blank.

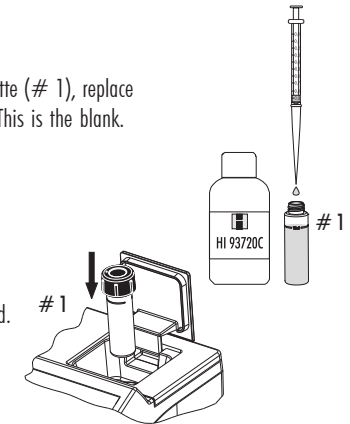

- Place the blank (# 1) into the holder and close the lid.

- Press the **Zero** key. The meter will show “-0.0-” when the meter is zeroed and ready for measurement.

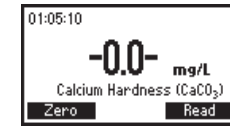
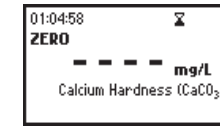
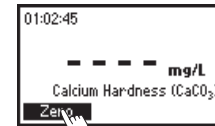

- Remove the blank and insert the second cuvette (# 2) into the instrument.

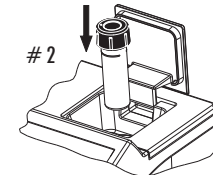

- Press **Read** to start the reading. The instrument displays concentration in mg/L of calcium hardness, as CaCO₃.

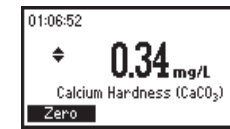
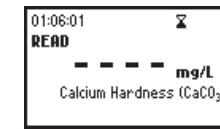
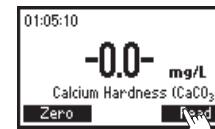

- Press **▲** or **▼** to access the second level functions.
- Press the **Chem Frm** key to convert the result in mg/L of Calcium (Ca²⁺).

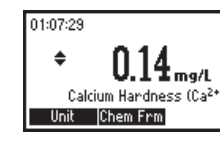
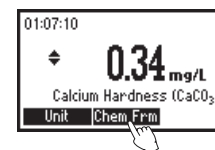

- Press the **Unit** key to change the current measurement unit. The results can be converted to French degrees (°f), German degrees (°dH) and English degrees (°E).

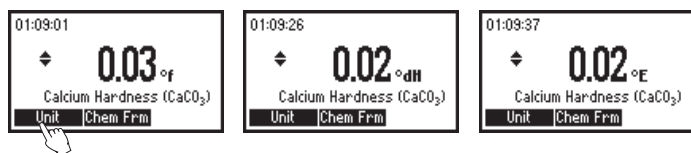

- Press **▲** or **▼** to return to the measurement screen.

Note: This test will detect any calcium contamination in the beaker, measuring syringes or sample cells. To test cleanliness, repeat the test multiple times until you obtain consistent results.

Note: For better accuracy wash glassware with HCl 6N.

SAMPLE DILUTION

This meter is designed to determine low levels of hardness, typically found in water purification systems. When testing some other sources of water, it is not uncommon to come across levels of hardness that are greater than the range of this meter.

This problem can be overcome through dilution. Dilutions must be performed with hardness-free water or the readings will be erroneous.

A dilution to reduce the level of hardness by a factor of one hundred is performed as follows:

- Fill a 1 mL syringe with the sample.
- Place the syringe in a 50 mL beaker, making sure that the beaker is clean and empty, and inject 0.5 mL into the beaker.
- Fill the beaker up to the 50 mL mark with hardness-free water.

INTERFERENCES

Interference may be caused by excessive amounts of heavy metals.

MAGNESIUM HARDNESS

SPECIFICATIONS

Range	0.00 to 2.00 mg/L
Resolution	0.01 mg/L
Accuracy	±0.11 mg/L ±5% of reading at 25 °C
Typical EMC Deviation	±0.02 mg/L
Light Source	Tungsten lamp with narrow band interference filter @ 525 nm
Method	Adaptation of the <i>Standard Methods for the Examination of Water and Wastewater, 19th edition</i> , EDTA colorimetric method. The reaction between magnesium and reagents causes a reddish-violet tint in the sample.

REQUIRED REAGENTS

<u>Code</u>	<u>Description</u>	<u>Quantity</u>
HI 93719A-0	Mg indicator	0.5 mL
HI 93719B-0	Alkali solution	0.5 mL
HI 93719C-0	EDTA solution	1 drop
HI 93719D-0	EGTA solution	1 drop

REAGENT SETS

HI 93719-01 Reagents for 100 tests

HI 93719-03 Reagents for 300 tests

For other accessories see page 132.

MEASUREMENT PROCEDURE

- Select the *Magnesium Hardness* method using the procedure described in the *Method Selection* section (see page 12).
- Rinse a graduated beaker several times with unreacted sample, before filling it to the 50 mL mark with the sample.
- Add 0.5 mL of HI 93719A-0 Magnesium indicator solution, then swirl to mix.
- Add 0.5 mL of HI 93719B-0 Alkali solution and swirl to mix. Use this solution to rinse 2 cuvettes.

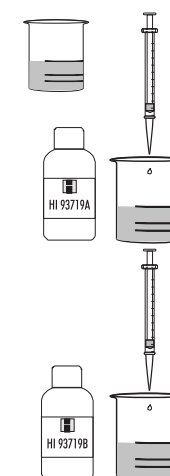

- Fill both cuvettes up to the 10 mL mark.

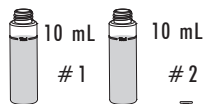

- Add 1 drop of HI 93719C-0 EDTA solution to one cuvette (# 1), replace the cap and invert the cuvette several times to mix. This is the blank.

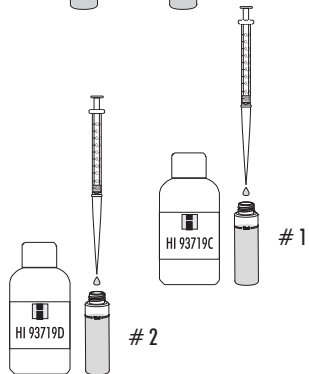

- Add 1 drop of HI 93719D-0 EDTA solution to the second cuvette (# 2), replace the cap and invert the cuvette several times to mix. This is the sample.

- Place the blank (# 1) into the holder and close the lid.

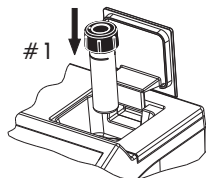

- Press the **Zero** key. The meter will show “-0.0-” when the meter is zeroed and ready for measurement.

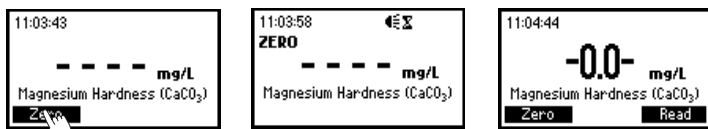

- Remove the blank (# 1), insert the sample (# 2) into the instrument, and close the lid.

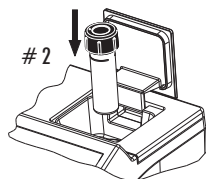

- Press **Read** to start the reading. The instrument displays concentration in **mg/L of magnesium hardness, as CaCO₃**.

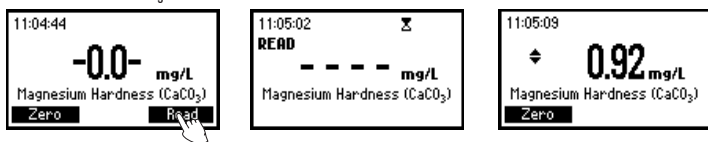

- Press **▲** or **▼** to access the second level functions.
- Press the **Chem Frm** key to convert the result in mg/L of Magnesium (Mg²⁺).

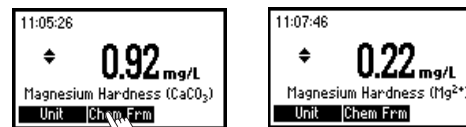

- Press the **Unit** key to change the current measurement unit. The results can be converted to French degrees (°f), German degrees (°dH) and English degrees (°E).

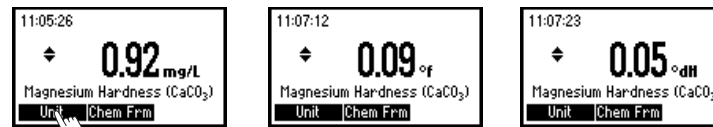

- Press **▲** or **▼** to return to the measurement screen.

Note: This test will detect any magnesium contamination in the beakers, measuring syringes or sample cells. To test cleanliness, repeat the test multiple times until you obtain consistent results.

SAMPLE DILUTION

This meter is designed to determine hardness typically found in water purification systems. In order to measure samples with high hardness, follow dilution procedure explained on page 58 (Ca Hardness).

INTERFERENCES

Interference may be caused by excessive amounts of heavy metals.

HYDRAZINE

SPECIFICATIONS

Range	0 to 400 µg/L
Resolution	1 µg/L
Accuracy	±4% of full scale reading at 25 °C
Typical EMC Deviation	±2 µg/L
Light Source	Tungsten lamp with narrow band interference filter @ 420 nm
Method	Adaptation of the <i>ASTM Manual of Water and Environmental Technology, method D1385-88</i> , p-Dimethylaminobenzaldehyde method. The reaction between hydrazine and the liquid reagent causes a yellow tint in the sample.

REQUIRED REAGENT

Code	Description	Quantity
HI 93704-0	Liquid Reagent	24 drops

REAGENT SETS

HI 93704-01 Reagents for 100 tests
 HI 93704-03 Reagents for 300 tests
 For other accessories see page 132.

MEASUREMENT PROCEDURE

- Select the *Hydrazine* method using the procedure described in the *Method Selection* section (see page 12).

- Fill one cuvette up to the mark with 10 mL of distilled water.

- Place the cap, insert the cuvette # 1 into the holder and close the lid.

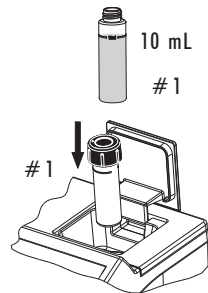

- Press the **Blank** key to start adjusting the light level. The display will show "Blank done" when the meter is ready to take a zero measurement.

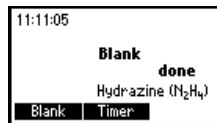
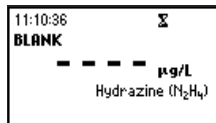
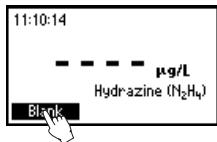

- Fill a second cuvette with 10 mL of unreacted sample (up to the mark) and replace the cap.



- Add 12 drops of the HI 93704-0 reagent to each cuvette. Replace the caps and shake gently to mix (about 30 seconds).

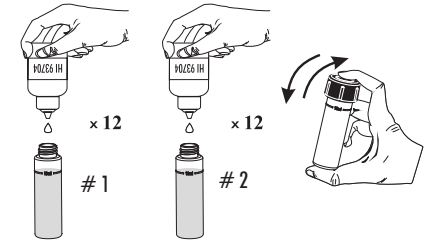

- Place the blank (#1) into the holder and close the lid.

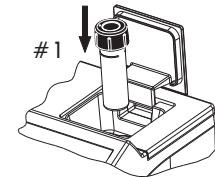

- Press **Timer** and the display will show the countdown prior to zeroing the blank. The display will show "-0.0-" when the meter is zeroed and ready for measurement.

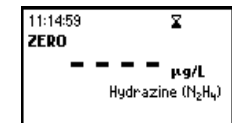
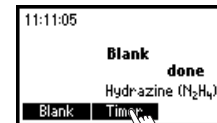

- Remove the blank.
- Insert the cuvette with the reacted sample (# 2) into the instrument and close the lid.

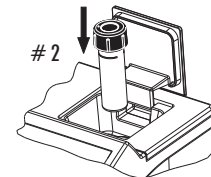

- Press **Read** to start the reading. The instrument displays concentration in µg/L of hydrazine.

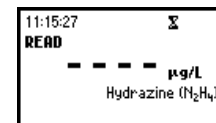
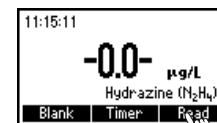

INTERFERENCES

Interference may be caused by:
 Highly colored samples
 Highly turbid samples
 Aromatic amines

IODINE

SPECIFICATIONS

Range	0.0 to 12.5 mg/L
Resolution	0.1 mg/L
Accuracy	±0.1 mg/L ±5% of reading at 25 °C
Typical EMC	±0.1 mg/L
Deviation	
Light Source	Tungsten lamp with narrow band interference filter @ 525 nm
Method	Adaptation of the <i>Standard Methods for the Examination of Water and Wastewater, 18th edition</i> , DPD method. The reaction between iodine and the reagent causes a pink tint in the sample.

REQUIRED REAGENTS

Code	Description	Quantity
HI 93718-0	DPD Reagent	1 packet

REAGENT SETS

HI 93718-01 Reagents for 100 tests

HI 93718-03 Reagents for 300 tests

For other accessories see page 132.

MEASUREMENT PROCEDURE

- Select the *Iodine* method using the procedure described in the *Method Selection* section (see page 12).
- Fill the cuvette with 10 mL of unreacted sample (up to the mark) and replace the cap.
- Place the cuvette into the holder and close the lid.

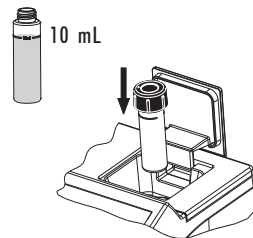

- Press the **Zero** key. The display will show “-0.0-” when the meter is zeroed and ready for measurement.

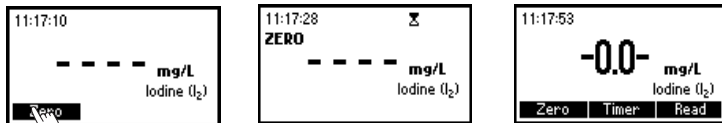

- Remove the cap and add the content of one packet of HI 93718-0 DPD reagent. Replace the cap and shake gently for about 30 seconds to dissolve most of the reagent.

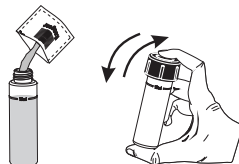

- Reinsert the cuvette into the instrument.

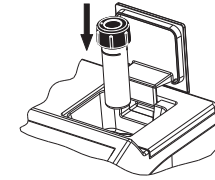

- Press **Timer** and the display will show the countdown prior to the measurement or, alternatively, wait for 2 minutes and 30 seconds and press **Read**. When the timer ends the meter will perform the reading.



- The instrument displays concentration in mg/L of iodine.

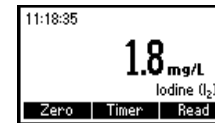

INTERFERENCES

Interference may be caused by: Bromine, Chlorine, Ozone, Oxidized forms of Chromium and Manganese. In case of water with hardness greater than 500 mg/L CaCO₃, shake the sample for approximately 2 minutes after adding the reagent.

In case of water with alkalinity greater than 250 mg/L CaCO₃ or acidity greater than 150 mg/L CaCO₃, the color of the sample may develop only partially, or may rapidly fade. To resolve this, neutralize the sample with diluted HCl or NaOH.

IRON HIGH RANGE

SPECIFICATIONS

Range	0.00 to 5.00 mg/L
Resolution	0.01 mg/L
Accuracy	±0.04 mg/L ±2% of reading at 25 °C
Typical EMC Deviation	±0.01 mg/L
Light Source	Tungsten lamp with narrow band interference filter @ 525 nm
Method	Adaptation of the <i>EPA Phenanthroline method 315B</i> , for natural and treated waters. The reaction between iron and reagents causes an orange tint in the sample.

REQUIRED REAGENTS

Code	Description	Quantity
HI 93721-0	Powder Reagent	1 packet

REAGENT SETS

HI 93721-01 Reagents for 100 tests

HI 93721-03 Reagents for 300 tests

For other accessories see page 132.

MEASUREMENT PROCEDURE

- Select the *Iron HR* method using the procedure described in the *Method Selection* section (see page 12).
- Fill the cuvette with 10 mL of unreacted sample (up to the mark) and replace the cap.
- Place the cuvette into the holder and close the lid.
- Press the **Zero** key. The display will show “-0.0-” the meter is zeroed and ready for measurement.

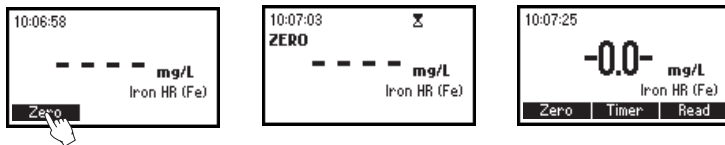
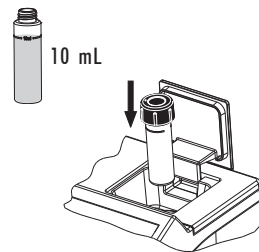

- Remove the cuvette and add the content of one packet of HI 93721-0 reagent. Replace the cap and shake until dissolution is complete.

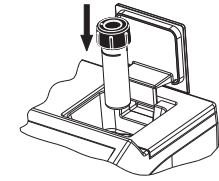
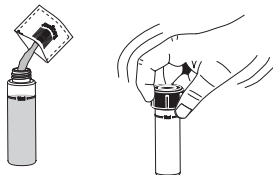

- Reinsert the cuvette into the instrument.
- Press **Timer** and the display will show the countdown prior to the measurement or, alternatively, wait for 3 minutes and press **Read**. When the timer ends the meter will perform the reading.



- The instrument displays concentration in **mg/L** of iron.



INTERFERENCES

Interference may be caused by:

Molybdate Molybdenum above 50 ppm

Calcium above 10000 ppm (as CaCO₃)

Magnesium above 100000 ppm (as CaCO₃)

Chloride above 185000 ppm.

IRON LOW RANGE

SPECIFICATIONS

Range	0 to 400 µg/L
Resolution	1 µg/L
Accuracy	±10 µg/L ±8% of reading at 25 °C
Typical EMC	±1 µg/L
Deviation	
Light Source	Tungsten lamp with narrow band interference filter @ 575 nm
Method	Adaptation of the TPTZ Method. The reaction between iron and the reagent causes a violet tint in the sample.

REQUIRED REAGENTS

Code	Description	Quantity
HI 93746-0	TPTZ Reagent	2 packets

REAGENT SETS

HI 93746-01 Reagents for 50 tests

HI 93746-03 Reagents for 150 tests

For other accessories see page 132.

MEASUREMENT PROCEDURE

- Select the *Iron LR* method using the procedure described in the *Method Selection* section (see page 12).
- Fill one graduated mixing cylinder up to the 25 mL mark with deionized water.
- Add the content of one packet of HI 93746-0 TPTZ reagent, close the cylinder and shake vigorously for 30 seconds. This is the blank.
- Fill a cuvette with 10 mL of the blank up to the mark and replace the cap.
- Place the cuvette into the holder and close the lid.

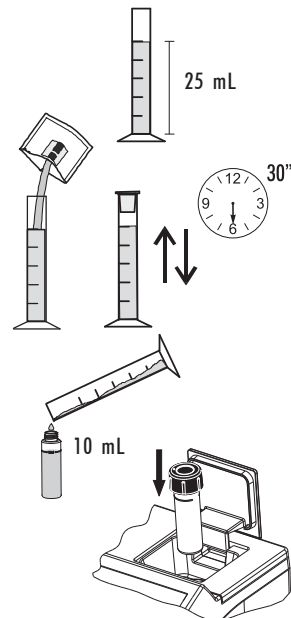

- Press the **Zero** key. The display will show “-0.0-” when the meter is zeroed and ready for measurement.

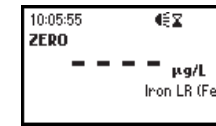
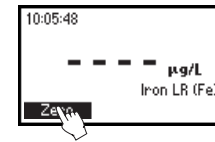

- Remove the cuvette.
- Fill another graduated mixing cylinder up to the 25 mL mark with the sample.
- Add the content of one packet of HI 93746-0 TPTZ reagent, close the cylinder and shake vigorously for 30 seconds. This is the reacted sample.
- Fill a cuvette with 10 mL of the reacted sample up to the mark and replace the cap.

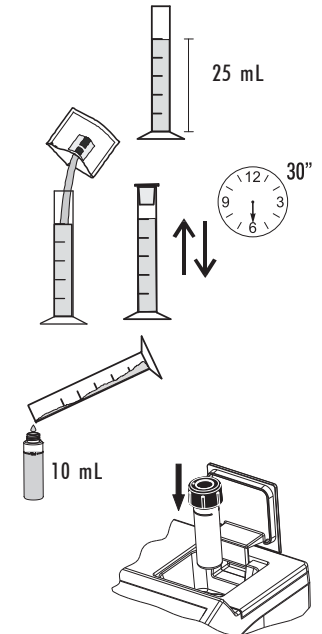

- Insert the sample into the instrument.
- Press **Timer** and the display will show the countdown prior to the measurement or, alternatively, wait for 30 seconds and press **Read**. When the timer ends the meter will perform the reading. The instrument displays concentration in µg/L of iron.

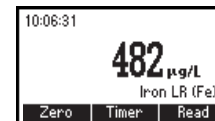
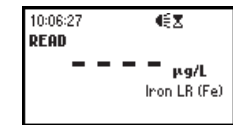
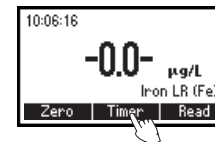

INTERFERENCES

Interference may be caused by:

Cadmium above 4.0 mg/L

Chromium³⁺ above 0.25 mg/L

Chromium⁶⁺ above 1.2 mg/L

Cobalt above 0.05 mg/L

Copper above 0.6 mg/L

Cyanide above 2.8 mg/L

Manganese above 50.0 mg/L

Mercury above 0.4 mg/L

Molybdenum above 4.0 mg/L

Nickel above 1.0 mg/L

Nitrite ion above 0.8 mg/L

Sample pH should be between 3 and 4 to avoid developed color to fade or turbidity formation.

MAGNESIUM

SPECIFICATIONS

Range 0 to 150 mg/L

Resolution 5 mg/L

Accuracy ± 5 mg/L $\pm 3\%$ of reading at 25 °C

Light Source Tungsten lamp with narrow band interference filter @ 466 nm

Method Adaptation of the Calmagite method.

REQUIRED REAGENTS

Code	Description	Quantity
HI 93752A-0 Mg	Magnesium Buffer Reagent	1 mL
HI 93752B-0 Mg	Magnesium Indicator Reagent	9 mL

REAGENT SETS

HI 937520-01 Reagents for 50 tests

HI 937520-03 Reagents for 150 tests

For other accessories see page 132.

MEASUREMENT PROCEDURE

Note: for sample preparation follow the COLORED OR TURBID SAMPLES procedure on page 17.

- Select the *Magnesium* method using the procedure described in the *Method Selection* section (see page 12).
- Using one 1 mL syringe add exactly 1.00 mL of HI 93752A-0 Mg Buffer reagent to the cuvette and use the pipette to fill the cuvette up to the 10 mL mark with the HI 93752B-0 Mg Indicator reagent.

- Replace the cap and invert several times to mix.

- Place the cuvette into the holder and close the lid.

- Press the **Zero** key. The display will show “-0.0-” when the meter is zeroed and ready for measurement.

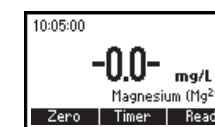
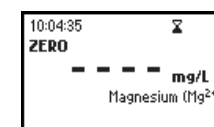
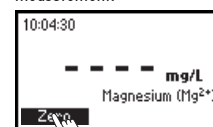
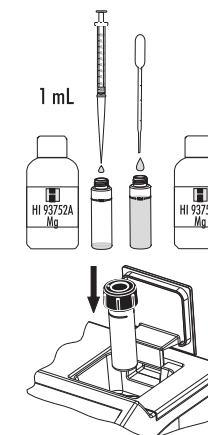

- Remove the cuvette.
- Using the other 1 mL syringe, add to the cuvette exactly 0.5 mL of sample.
Note: Do not mix up the two syringes!
- Replace the cap and invert several times to mix.
- Reinsert the cuvette into the instrument.

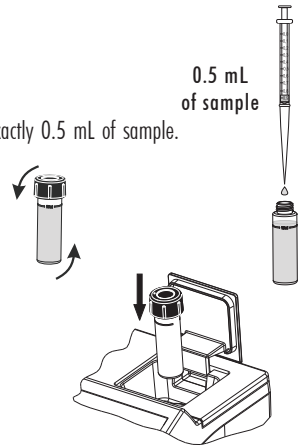

- Press **Timer** and the display will show the countdown prior to the measurement or, alternatively, wait for 15 seconds and press **Read**. When the timer ends the meter will perform the reading.



- The instrument displays the results in mg/L of magnesium (Mg^{2+}).

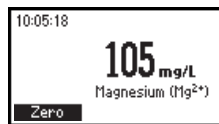

INTERFERENCES

Interferences may be caused by:

- Acidity (as $CaCO_3$) above 1000 mg/L
- Alkalinity (as $CaCO_3$) above 1000 mg/L
- Calcium (Ca^{2+}) above 200 mg/L
- Iron must be absent
- Aluminum must be absent
- Copper must be absent

MANGANESE HIGH RANGE

SPECIFICATIONS

Range	0.0 to 20.0 mg/L
Resolution	0.1 mg/L
Accuracy	± 0.2 mg/L $\pm 3\%$ of reading at 25 °C
Typical EMC Deviation	± 0.1 mg/L
Light Source	Tungsten lamp with narrow band interference filter @ 525 nm
Method	Adaptation of the <i>Standard Methods for the Examination of Water and Wastewater, 18th edition</i> , Periodate method. The reaction between manganese and reagents causes a pink tint in the sample.

REQUIRED REAGENTS

Code	Description	Quantity
HI 93709A-0	Citrate	1 packet
HI 93709B-0	Sodium periodate	1 packet

REAGENT SETS

- HI 93709-01 Reagents for 100 tests
 - HI 93709-03 Reagents for 300 tests
- For other accessories see page 132.

MEASUREMENT PROCEDURE

- Select the *Manganese HR* method using the procedure described in the *Method Selection* section (see page 12).
- Fill the cuvette with 10 mL of unreacted sample (up to the mark) and replace the cap.
- Place the cuvette into the holder and close the lid.
- Press the **Zero** key. The display will show “-0.0-” when the meter is zeroed and ready for measurement.

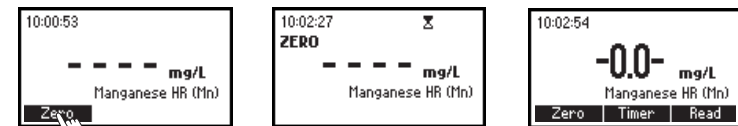
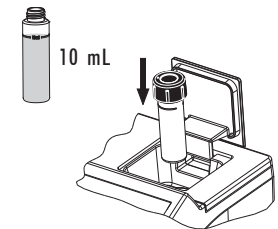

- Remove the cuvette.
- Add the content of one packet of HI 93709A-0 Citrate reagent. Replace the cap and invert to mix with gently movements for 2 minutes.

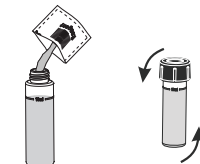

- Add the content of one packet of HI 93709B-0 Sodium Periodate reagent. Replace the cap and invert to mix with gently movements for 2 minutes.

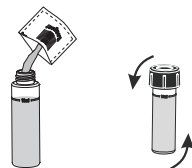

- Reinsert the cuvette into the instrument.

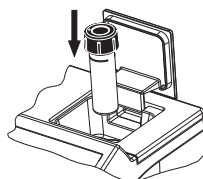

- Press **Timer** and the display will show the countdown prior to the measurement or, alternatively, wait for 1 minute and 30 seconds and press **Read**. When the timer ends the meter will perform the reading. The instrument displays the results in mg/L of manganese.



- Press ▲ or ▼ to access the second level functions.
- Press the **Chem Frm** key to convert the result in mg/L of potassium permanganate (KMnO_4) and permanganate (MnO_4^-).

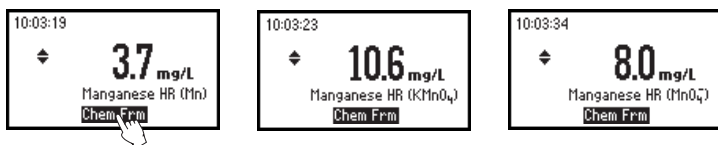

- Press ▲ or ▼ to return to the measurement screen.

INTERFERENCES

Interference may be caused by:
 Calcium above 700 mg/L
 Chloride above 70000 mg/L
 Iron above 5 mg/L
 Magnesium above 100000 mg/L.

MANGANESE LOW RANGE

SPECIFICATIONS

Range	0 to 300 $\mu\text{g/L}$
Resolution	1 $\mu\text{g/L}$
Accuracy	$\pm 10 \mu\text{g/L} \pm 3\%$ of reading at 25 °C
Typical EMC	$\pm 1 \mu\text{g/L}$
Deviation	
Light Source	Tungsten lamp with narrow band interference filter @ 575 nm
Method	Adaptation of the PAN Method. The reaction between manganese and the reagents causes an orange tint in the sample.

REQUIRED REAGENT

Code	Description	Quantity
HI 93748A-0	Ascorbic acid	2 packets
HI 93748B-0	Alkaline-cyanide sol.	0.40 mL
HI 93748C-0	0.1% PAN indicator	2 mL
HI 93703-51	Dispersing Agent	4-6 drops

REAGENT SETS

HI 93748-01 Reagents for 50 tests
 HI 93748-03 Reagents for 150 tests
 For other accessories see page 132.

MEASUREMENT PROCEDURE

- Select the *Manganese LR* method using the procedure described in the *Method Selection* section (see page 12).

- Fill one cuvette with 10 mL of deionized water (up to the mark).



- Fill a second cuvette with 10 mL of sample (up to the mark).



- Add the content of one packet of HI 93748A-0 Ascorbic acid to each cuvette, replace the caps and shake gently until completely dissolved.

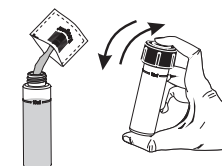

- Add 0.2 mL of the HI 93748B-0 Alkaline-cyanide reagent solution to each cuvette, replace the caps and invert gently to mix for about 30 seconds.

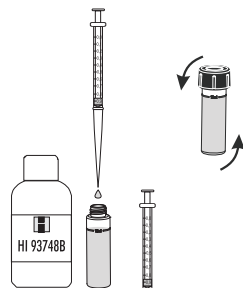

- Add 1 mL of the HI 93748C-0 0.1% PAN indicator solution to each cuvette, replace the caps and shake gently.

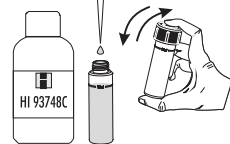

- Add 3 drops of Dispersing Agent (HI 93703-51) to each cuvette, replace the caps and invert gently to mix for about 30 seconds.

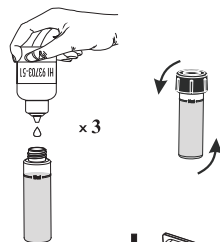

- Place the cuvette with the reacted deionized water (blank) into the holder and close the lid.

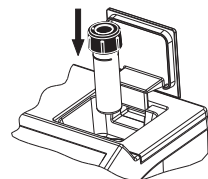

- Press **Timer** and the display will show the countdown prior to zeroing the blank. Alternatively wait for 2 minutes and then press **Zero**. The display will show “-0.0-” when the meter is zeroed and ready for measurement.

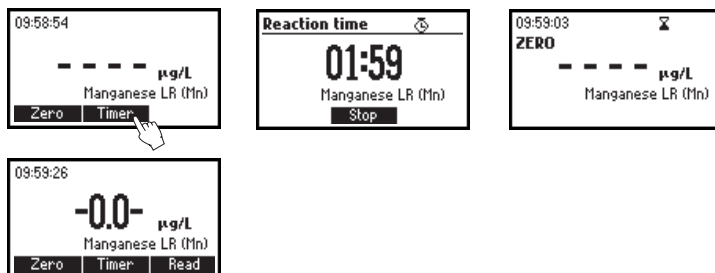

- Insert the second cuvette with the reacted sample into the instrument.

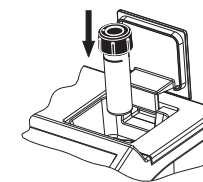

- Press **Read** to start the reading. The instrument displays the results in $\mu\text{g/L}$ of manganese.

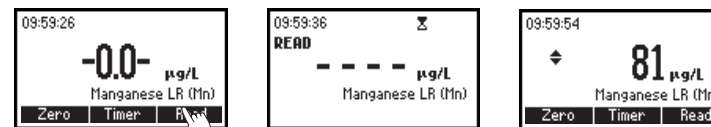

- Press \blacktriangle or \blacktriangledown to access the second level functions.
- Press the **Chem Frm** key to convert the result in $\mu\text{g/L}$ of potassium permanganate (KMnO_4) and permanganate (MnO_4^-).

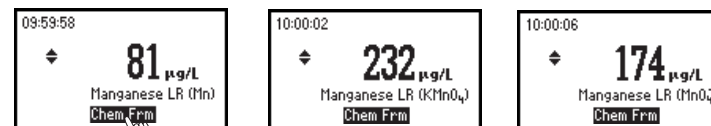

- Press \blacktriangle or \blacktriangledown to return to the measurement screen.

INTERFERENCES

Interference may be caused by:

Aluminum above 20 mg/L

Cadmium above 10 mg/L

Calcium above 200 mg/L as CaCO_3

Cobalt above 20 mg/L

Copper above 50 mg/L

Iron above 10 mg/L

Lead above 0.5 mg/L

Magnesium above 100 mg/L as CaCO_3

Nickel above 40 mg/L

Zinc above 15 mg/L.

MOLYBDENUM

SPECIFICATIONS

Range	0.0 to 40.0 mg/L
Resolution	0.1 mg/L
Accuracy	±0.3 mg/L ±5% of reading at 25 °C
Typical EMC Deviation	±0.1 mg/L
Light Source	Tungsten lamp with narrow band interference filter @ 420 nm
Method	Adaptation of the mercaptoacetic acid method. The reaction between molybdenum and the reagents causes a yellow tint in the sample.

REQUIRED REAGENT

Code	Description	Quantity
HI 93730A-0	Reagent A	1 packet
HI 93730B-0	Reagent B	1 packet
HI 93730C-0	Reagent C	1 packet

REAGENT SETS

HI 93730-01 Reagents for 100 tests

HI 93730-03 Reagents for 300 tests

For other accessories see page 132.

MEASUREMENT PROCEDURE

- Select the *Molybdenum* method using the procedure described in the *Method Selection* section (see page 12).
- Fill the cuvette with 10 mL of unreacted sample (up to the mark) and replace the cap.

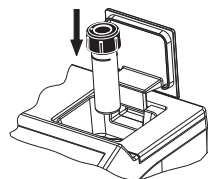

- Place cuvette into the holder and close the lid.

- Press the **Zero** key. The display will show “-0.0-” when the meter is zeroed and ready for measurement.

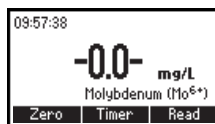
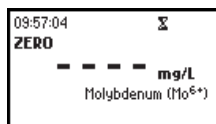
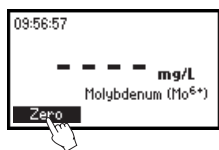

- Fill one graduated mixing cylinder up to the 25 mL mark with the sample.

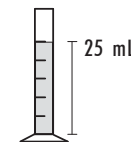

- Add the content of one packet of HI 93730A-0 molybdenum reagent, close the cylinder and invert it several times until completely dissolved.

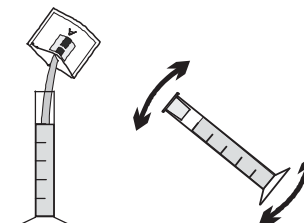

- Add the content of one packet of HI 93730B-0 molybdenum reagent to the cylinder, close and invert it several times until completely dissolved.

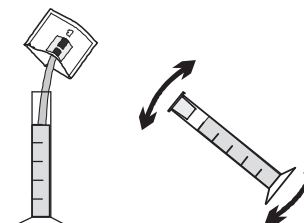

- Add the content of one packet of HI 93730C-0 molybdenum reagent to the cylinder, close and shake it vigorously.

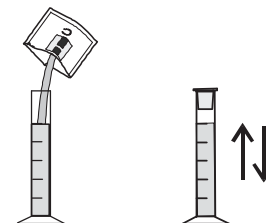

- Fill an empty cuvette with 10 mL of sample up to the mark and replace the cap.

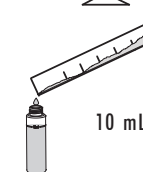

- Insert the cuvette into the instrument.

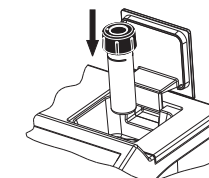

- Press **Timer** and the display will show the countdown prior to the measurement or, alternatively, wait for five minutes and press **Read**. When the timer ends the meter will perform the reading. The instrument displays concentration in **mg/L of molybdenum**.

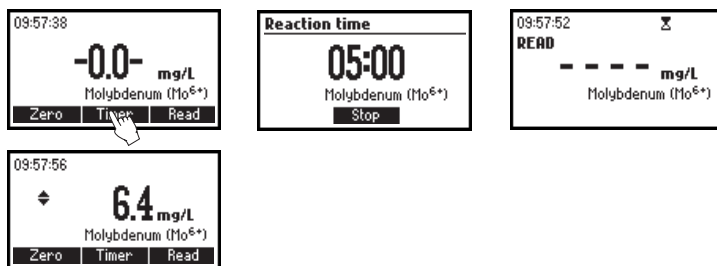

- Press **▲** or **▼** to access the second level functions.
- Press the **Chem Frm** key to convert the result in mg/L of molybdate (MoO_4^{2-}) and sodium molybdate (Na_2MoO_4).

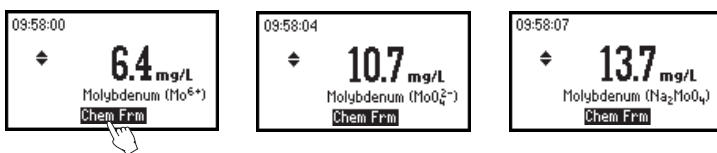

- Press **▲** or **▼** to return to the measurement screen.

INTERFERENCES

Interference may be caused by:

Aluminum above 50 mg/L

Chromium above 1000 mg/L

Copper above 10 mg/L

Iron above 50 mg/L

Nickel above 50 mg/L

Nitrite, as NO_2^-

Sulfate above 200 mg/L

Highly buffered samples or with extreme pH may exceed the buffering capacity of the reagents.

NICKEL HIGH RANGE

SPECIFICATIONS

Range	0.00 to 7.00 g/L
Resolution	0.01 g/L
Accuracy	$\pm 0.07 \pm 4\%$ of reading at 25 °C
Typical EMC	± 0.02 g/L
Deviation	
Light Source	Tungsten lamp with narrow band interference filter @ 575 nm
Method	Adaptation of the photometric method. The reaction between nickel and the reagent causes a blue tint in the sample.

REQUIRED REAGENTS

Code	Description	Quantity
HI 93726-0	Powder reagent	1 packet

REAGENT SETS

HI 93726-01 Reagents for 100 tests

HI 93726-03 Reagents for 300 tests

For other accessories see page 132.

MEASUREMENT PROCEDURE

- Select the *Nickel HR* method using the procedure described in the *Method Selection* section (see page 12).

- Fill the cuvette up to the mark with 10 mL of unreacted sample and replace the cap.



- Place the cuvette into the holder and close the lid.

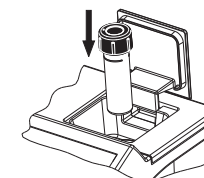

- Press the **Zero** key. The display will show “-0.0-” when the meter is zeroed and ready for measurement.

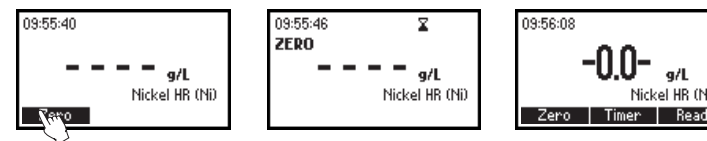

- Remove the cuvette and add the content of one packet of HI 93726-0 reagent. Replace the cap and shake gently until completely dissolved.

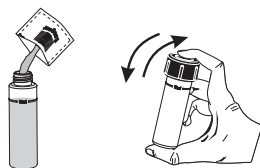

- Reinsert the cuvette into the instrument.

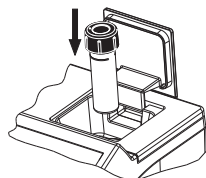

- Press **Timer** and the display will show the countdown prior to the measurement or, alternatively, wait for 1 minute and press **Read**. When the timer ends the meter will perform the reading.

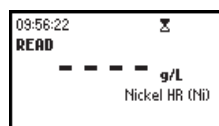
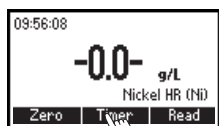

- The instrument displays concentration in **g/L** of nickel.

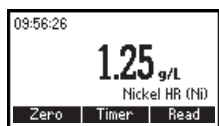

INTERFERENCES

Interference may be caused by copper.

NICKEL LOW RANGE

SPECIFICATIONS

Range	0.000 to 1.000 mg/L	
Resolution	0.001 mg/L	
Accuracy	±0.010 mg/L ±7% of reading at 25 °C	
Typical EMC	±0.001 mg/L	
Deviation		
Light Source	Tungsten lamp with narrow band interference filter @ 575 nm	
Method	Adaptation of the PAN method. The reaction between nickel and the reagents causes an orange tint in the sample.	

REQUIRED REAGENTS

Code	Description	Quantity
HI 93740A-0	Phthalate-phosphate	2 packets
HI 93740B-0	0.3% PAN indicator	2 mL
HI 93740C-0	EDTA	2 packets
HI 93703-51	Dispersing Agent	4-6 drops (only when necessary, see note)

REAGENT SETS

HI 93740-01 Reagents for 50 tests

HI 93740-03 Reagents for 150 tests

For other accessories see page 132.

MEASUREMENT PROCEDURE

- Select the *Nickel LR* method using the procedure described in the *Method Selection* section (see page 12).

Note: for best results perform your tests between 20-24°C.

- Fill one graduated beaker with 25 mL of deionized water (blank) and another one with 25 mL of sample.

- Add the content of one packet of HI 93740A-0 Phthalate-phosphate reagent to each beaker. Cap and swirl gently until the reagent is dissolved.

Note: If sample contains iron (Fe^{3+}), it is important that all powder be dissolved completely before continuing with following step.

- Add 1 mL of HI 93740B-0 0.3% PAN solution to each beaker, cap and swirl to mix.

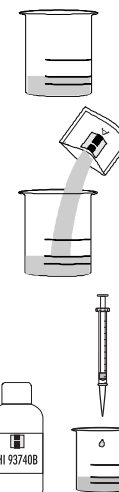

- Press **Timer** and the display will show a countdown prior to adding reagent C or, alternatively, wait for 15 minutes. Add one packet of HI 93740C-0 EDTA reagent to each beaker, cap and swirl to mix until completely dissolved.

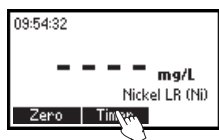

- Fill one cuvette up to the mark with 10 mL of the blank.



- Place the cuvette into the holder and close the lid.

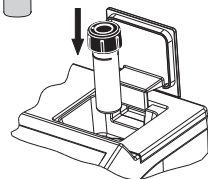

- Press the **Zero** key. The display will show “-0.0-” when the meter is zeroed and ready for measurement.

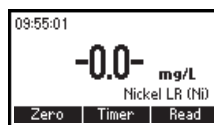
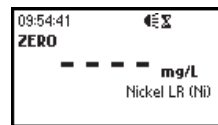
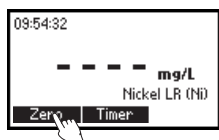

- Fill a second cuvette up to the mark with 10 mL of the reacted sample.



- Insert the second cuvette into the instrument.

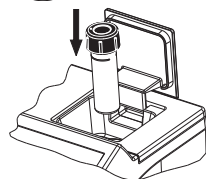

- Press **Read** to start the reading. The instrument displays the results in mg/L of nickel.

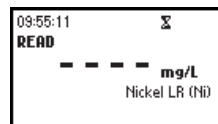

Note: a temperature above 30°C may cause turbidity. In this case, before zeroing and taking readings, add 2-3 drops of Dispersing Agent (HI 93703-51) to each cuvette and swirl until turbidity is removed.

INTERFERENCES

Interference may be caused by:

Co^{2+} must not be present

Fe^{2+} must not be present

Al^{3+} above 32 mg/L

Ca^{2+} above 1000 mg/L (as CaCO_3)

Cd^{2+} above 20 mg/L

Cl^- above 8000 mg/L

Cr^{3+} above 20 mg/L

Cr^{6+} above 40 mg/L

Cu^{2+} above 15 mg/L

F^- above 20 mg/L

Fe^{3+} above 10 mg/L

K^+ above 500 mg/L

Mg^{2+} above 400 mg/L

Mn^{2+} above 25 mg/L

Mo^{6+} above 60 mg/L

Na^+ above 5000 mg/L

Pb^{2+} above 20 mg/L

Zn^{2+} above 30 mg/L

NITRATE

SPECIFICATIONS

Range	0.0 to 30.0 mg/L
Resolution	0.1 mg/L
Accuracy	±0.5 mg/L ±10% of reading at 25 °C
Typical EMC Deviation	±0.1 mg/L
Light Source	Tungsten lamp with narrow band interference filter @ 525 nm
Method	Adaptation of the cadmium reduction method. The reaction between nitrate and the reagent causes an amber tint in the sample.

REQUIRED REAGENTS

Code	Description	Quantity
HI 93728-0	Powder reagent	1 packet

REAGENT SETS

HI 93728-01 Reagents for 100 tests
 HI 93728-03 Reagents for 300 tests
 For other accessories see page 132.

MEASUREMENT PROCEDURE

- Select the *Nitrate* method using the procedure described in the *Method Selection* section (see page 12).
- Using the pipette, fill the cuvette with 6 ml of sample, up to half of its height, and replace the cap.
- Place the cuvette into the holder and close the lid.

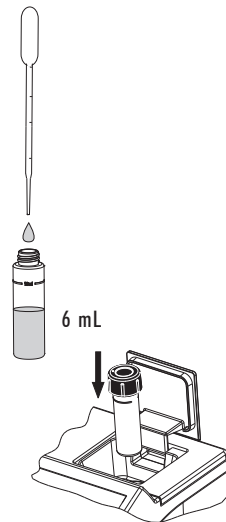

- Press the **Zero** key. The display will show “-0.0-” when the meter is zeroed and ready for measurement.

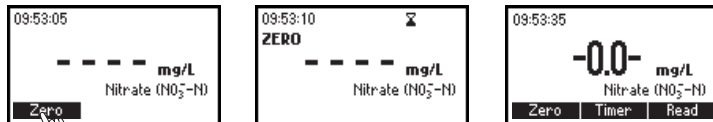

- Remove the cuvette and add the content of one packet of HI 93728-0 reagent.



- Replace the cap and immediately shake vigorously up and down for exactly 10 seconds. Continue to mix by inverting the cuvette gently for 50 seconds, while taking care not to induce air bubbles. Powder will not completely dissolve. Time and way of shaking could sensitively affect the measurement.
- Reinsert the cuvette into the instrument, taking care not to shake it.
- Press **Timer** and the display will show the countdown prior to the measurement or, alternatively, wait for 4 minutes and 30 seconds and press **Read**. When the timer ends the meter will perform the reading. The instrument displays the results in **mg/L of nitrate-nitrogen**.

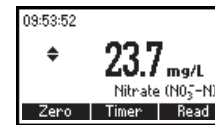
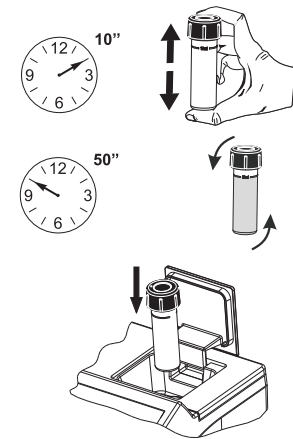

- Press **▲** or **▼** to access the second level functions.
- Press the **Chem Frm** key to convert the result in mg/L of nitrate (NO_3^-).

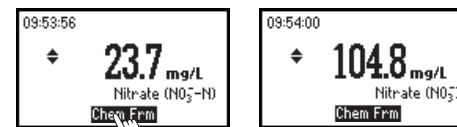

- Press **▲** or **▼** to return to the measurement screen.

INTERFERENCES

Interference may be caused by:
 Ammonia and amines, as urea and primary aliphatic amines
 Chloride above 100 ppm
 Chlorine above 2 ppm
 Copper
 Iron(III)
 Strong oxidizing and reducing substances
 Sulfide must be absent

NITRITE HIGH RANGE

SPECIFICATIONS

Range	0 to 150 mg/L
Resolution	1 mg/L
Accuracy	±4 mg/L ±4% of reading at 25 °C
Typical EMC	±1 mg/L
Deviation	
Light Source	Tungsten lamp with narrow band interference filter @ 575 nm
Method	Adaptation of the Ferrous Sulfate method. The reaction between nitrite and the reagent causes a greenish-brown tint in the sample.

REQUIRED REAGENTS

Code	Description	Quantity
HI 93708-0	Powder reagent	1 packet

REAGENT SETS

HI 93708-01 Reagents for 100 tests

HI 93708-03 Reagents for 300 tests

For other accessories see page 132.

MEASUREMENT PROCEDURE

- Select the *Nitrite HR* method using the procedure described in the *Method Selection* section (see page 12).
- Fill the cuvette up to the mark with 10 mL of unreacted sample and replace the cap.
- Place the cuvette into the holder and close the lid.

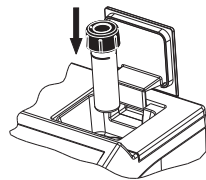

- Press the **Zero** key. The display will show “-0.0-” when the meter is zeroed and ready for measurement.

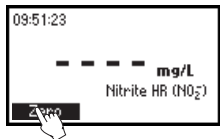

- Remove the cuvette.

- Add the content of one packet of HI 93708-0 reagent. Replace the cap and shake gently until completely dissolved.

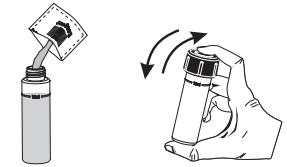

- Reinsert the cuvette into the instrument.

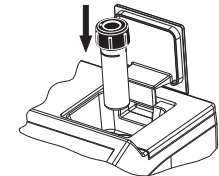

- Press **Timer** and the display will show the countdown prior to the measurement or, alternatively, wait for 10 minutes and press **Read**. When the timer ends the meter will perform the reading. The instrument displays concentration in **mg/L of nitrite**.

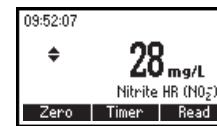
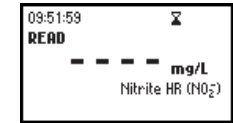

- Press **▲** or **▼** to access the second level functions.
- Press the **Chem Frm** key to convert the result in mg/L of nitrogen-nitrite (NO₂⁻-N) and sodium nitrite (NaNO₂).

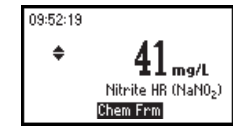

- Press **▲** or **▼** to return to the measurement screen.

NITRITE LOW RANGE

SPECIFICATIONS

Range	0.00 to 1.15 mg/L
Resolution	0.01 mg/L
Accuracy	±0.06 mg/L ±4% of reading at 25 °C
Typical EMC	±0.01 mg/L
Deviation	
Light Source	Tungsten lamp with narrow band interference filter @ 525 nm
Method	Adaptation of the EPA Diazotization method 354.1. The reaction between nitrite and the reagent causes a pink tint in the sample.

REQUIRED REAGENTS

Code	Description	Quantity
HI 93707-0	Powder reagent	1 packet

REAGENT SETS

HI 93707-01 Reagents for 100 tests

HI 93707-03 Reagents for 300 tests

For other accessories see page 132.

MEASUREMENT PROCEDURE

- Select the *Nitrite LR* method using the procedure described in the *Method Selection* section (see page 12).
- Fill the cuvette up to the mark with 10 mL of unreacted sample (up to the mark) and replace the cap.

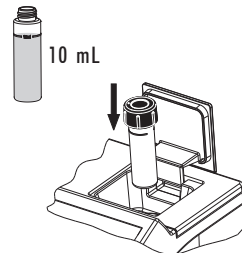

- Place the cuvette into the holder and close the lid.
- Press the **Zero** key. The display will show “-0.0-” when the meter is zeroed and ready for measurement.

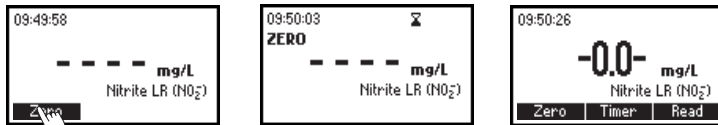

- Remove the cuvette.
- Add the content of one packet of HI 93707-0 reagent. Replace the cap and shake gently for about 15 seconds.

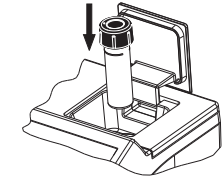
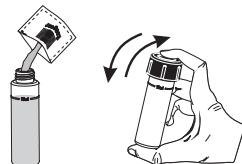

- Reinsert the cuvette into the instrument.
- Press **Timer** and the display will show the countdown prior to the measurement or, alternatively, wait for 6 minutes and press **Read**. When the timer ends the meter will perform the reading. The instrument displays concentration in **mg/L of nitrite**.

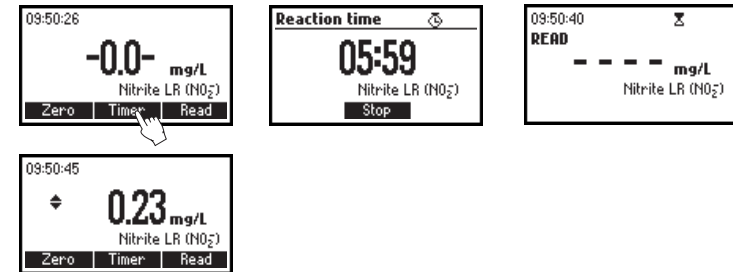

- Press **▲** or **▼** to access the second level functions.
- Press the **Chem Frm** key to convert the result in mg/L of nitrogen-nitrite (NO₂⁻-N) and sodium nitrite (NaNO₂).



- Press **▲** or **▼** to return to the measurement screen.

INTERFERENCES

Interference may be caused by the following ions:

ferrous, ferric, cupric, mercurous, silver, antimonious, bismuth, auric, lead, metavanadate and chloroplatinate. Strongly reducing and oxidizing reagents.

High levels of nitrate (above 100 mg/L) could yield falsely high readings due to a minute amount of reduction to nitrite that could occur at these levels.

DISSOLVED OXYGEN

SPECIFICATIONS

Range	0.0 to 10.0 mg/L
Resolution	0.1 mg/L
Accuracy	±0.4 mg/L ±3% of reading at 25 °C
Typical EMC	± 0.1 mg/L
Deviation	
Light Source	Tungsten lamp with narrow band interference filter @ 420 nm
Method	Adaptation of the <i>Standard Methods for the Examination of Water and Wastewater, 18th edition</i> , Azide modified Winkler method. The reaction between dissolved oxygen and the reagents causes a yellow tint in the sample.

REQUIRED REAGENTS

Code	Description	Quantity
HI 93732A-0	Reagent A	5 drops
HI 93732B-0	Reagent B	5 drops
HI 93732C-0	Reagent C	10 drops

REAGENT SET

HI 93732-01 Reagents for 100 tests
 HI 93732-03 Reagents for 300 tests
 For other accessories see page 132.

MEASUREMENT PROCEDURE

- Select the *Dissolved Oxygen* method using the procedure described in the *Method Selection* section (see page 12).
- Fill one 60 mL glass bottle completely with the unreacted sample.
- Replace the cap and ensure that a small part of the sample spills over.
- Remove the cap and add 5 drops of HI 93732A-0 and 5 drops of HI 93732B-0.
- Add more sample, to fill the bottle completely. Replace the cap again and ensure that a part of the sample spills over. This is to make sure that no air bubbles have been trapped inside, which could alter the reading.
- Invert several times the bottle. The sample becomes orange-yellow and a flocculent agent will appear.

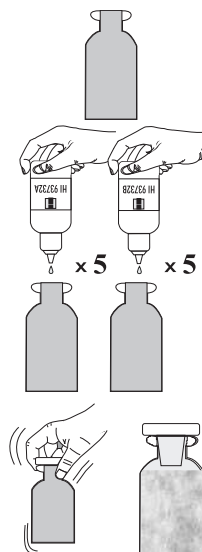

- Let the sample stand and the flocculent agent will start to settle.
- After approximately 2 minutes, when the upper half of the bottle becomes limpid, add 10 drops of HI 93732C-0.
- Replace the cap and invert the bottle until the settled flocculent dissolves completely. The sample is ready for measurement when it is yellow and completely limpid.

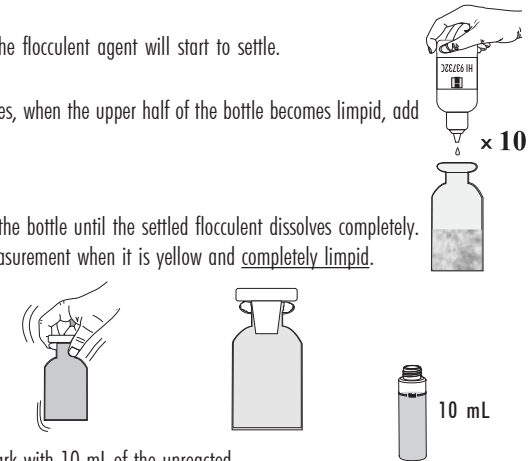

- Fill the cuvette up to the mark with 10 mL of the unreacted (original) sample, and replace the cap. This is the blank.
- Place the cuvette into the holder and close the lid.
- Press the **Zero** key. The display will show “-0.0-” when the meter is zeroed and ready for measurement.

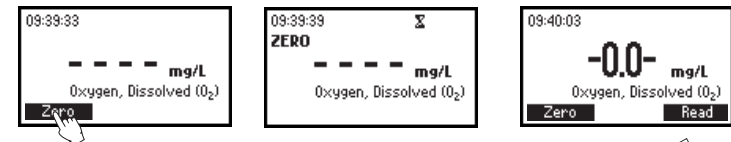
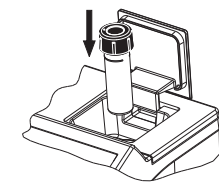

- Remove the cuvette.
- Fill another cuvette up to the mark with 10 mL of the reacted sample and replace the cap.
- Reinsert the cuvette into the instrument.
- Press **Read** to start the reading. The instrument will display the results in mg/L of dissolved oxygen.

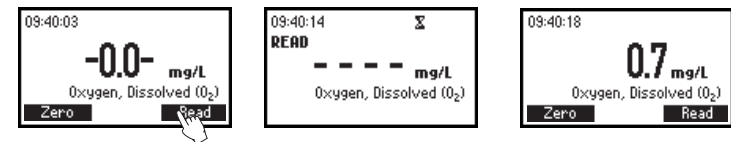

INTERFERENCES

Interferences may be caused by reducing and oxidizing materials.

OXYGEN DEMAND, CHEMICAL HIGH RANGE

SPECIFICATIONS

Range	0 to 15000 mg/L COD
Resolution	10 mg/L
Accuracy	± 150 mg/L or ± 3 % of reading @ 25 °C, whichever is greater
Typical EMC Deviation	± 10 mg/L
Light Source	Tungsten lamp with narrow band interference filter @ 610 nm
Method	Adaptation of the USEPA 410.4 approved method for the COD determination on surface waters and wastewaters. Oxidizable organic compounds reduce the dichromate ion (orange) to the chromic ion (green). The amount of chromic ion formed is determined.

REQUIRED REAGENTS

Description	Q.ty/test	Q.ty/set
Reagent Vial	1 vial	25 vials
Deionized Water	0.2 mL	optional

Note: Store the unused vials in their container in a cool and dark place.

REAGENT SET

HI 93754C-25 Reagents for up to 25 tests

REQUIRED ACCESSORIES

- HI 839800-01 Hanna reactor (115 VAC)
 - HI 839800-02 Hanna reactor (230 VAC)
 - HI 740216 Test tube cooling rack (25 holes)
 - HI 740217 Laboratory bench safety shield
- For other accessories see page 132.

MEASUREMENT PROCEDURE



Before using the reagent kit carefully read all the instructions and the Material Safety Data Sheet (MSDS). Pay particular attention to all warnings, cautions and notes. Failure to do so may result in serious injury to the operator.

Reagent Blank Correction: This method requires a reagent blank correction. A single blank vial may be used more than once. The blank vial is stable for several months (room temperature). For most accurate measurement, run a blank for each set of measurements and always use the same lot of reagents for blank and samples.

- Choose a homogeneous sample. Samples containing settleable solids need to be homogenized with a blender.
- Preheat the Hanna Reactor HI 839800 to 150 °C (302°F). For correct use of the reactor follow Reactor Instruction Manual.
Use of the optional HI 740217 safety shield is strongly recommended.
DO NOT USE AN OVEN OR MICROWAVE samples may leak and generate a corrosive and possibly explosive atmosphere.
- Remove the cap from two Reagent Vials.



- Add exactly 0.2 mL of sample to one vial (sample vial), and 0.2 mL of deionized water to the other vial (blank vial), while keeping the vials at a 45-degree angle. Replace the cap tightly and mix by inverting each vial a couple of times.

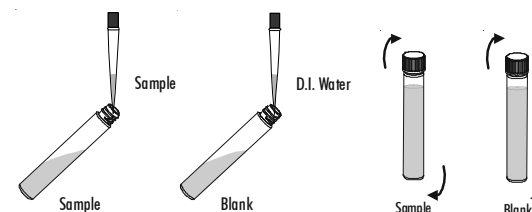

Warning: the vials will become very hot during mixing, be careful when handling them.

- Insert the vials into the reactor and heat them for 2 hours at 150°C.
- At the end of the digestion period switch off the reactor. Wait for twenty minutes to allow the vials to cool to about 120°C.



- Invert each vial several times while still warm, then place them in the test tube rack.
Warning: the vials are still hot, be careful when handling them.

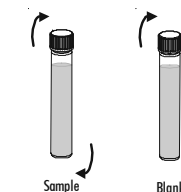

- Leave the vials in the tube rack to cool to room temperature. Do not shake or invert them anymore otherwise the samples may become turbid.



- Select the *Oxygen Demand, Chemical HR (COD)* method following one of the procedures described in the *Method Selection* section (see page 12).

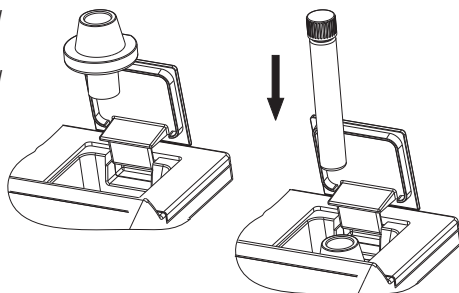

- Place the COD vial adapter in the cuvet holder and ensure that the adapter is well fit inside.
- Place the blank vial into the holder and push it completely down.
- Press the **Zero** key and the instrument will perform a zero sequence. If the zero sequence was successfully done, the display will show “-0.0-”. Now the meter is zeroed and ready for measurement.

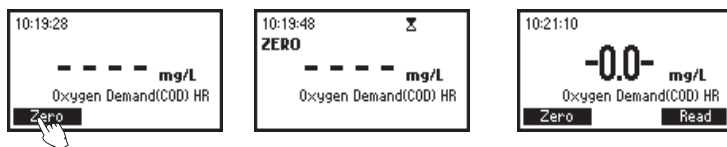

- Remove the blank vial.
- Place the sample vial into the holder and push it completely down.
- Press **Read** and the instrument will perform the reading.
- The instrument directly displays concentration in **mg/L of oxygen demand**.

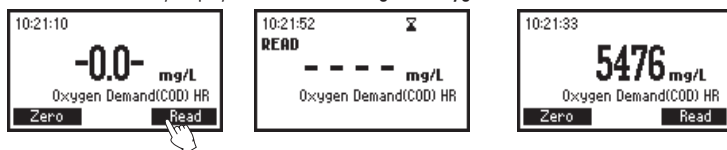

INTERFERENCES

Interference may be caused by:

Chloride (Cl^-) above 20000 mg/L.

Samples with higher chloride concentration should be diluted.

OXYGEN DEMAND, CHEMICAL MEDIUM RANGE

SPECIFICATIONS

Range	0 to 1500 mg/L COD
Resolution	1 mg/L
Accuracy	± 15 mg/L or ± 4 % of reading @ 25 °C, whichever is greater
Typical EMC Deviation	± 1 mg/L
Light Source	Tungsten lamp with narrow band interference filter @ 610 nm
Method	Adaptation of the USEPA 410.4 approved method for the COD determination on surface waters and wastewaters. Oxidizable organic compounds reduce the dichromate ion (orange) to the chromic ion (green). The amount of chromic ion formed is determined.

REQUIRED REAGENTS

Description	Q.ty/test	Q.ty/set
Reagent Vial	1 vial	25 vials
Deionized Water	2.0 mL	optional

Note: Store the unused vials in their container in a cool and dark place.

REAGENT SET

HI 93754B-25 Reagents for up to 25 tests

REQUIRED ACCESSORIES

HI 839800-01 Hanna reactor (115 VAC)

HI 839800-02 Hanna reactor (230 VAC)

HI 740216 Test tube cooling rack (25 holes)

HI 740217 Laboratory bench safety shield

For other accessories see page 132.

MEASUREMENT PROCEDURE



Before using the reagent kit carefully read all the instructions and the Manual Safety Data Sheet (MSDS). Pay particular attention to all warnings, cautions and notes. Failure to do so may result in serious injury to the operator.

Reagent Blank Correction: This method requires a reagent blank correction. A single blank vial may be used more than once. The blank vial is stable for several months (room temperature). For most accurate measurement, run a blank for each set of measurements and always use the same lot of reagents for blank and samples.

- Choose a homogeneous sample. Samples containing settleable solids need to be homogenized with a blender.
- Preheat the Hanna Reactor HI 839800 to 150 °C (302°F). For correct use of the reactor follow Reactor Instruction Manual.
Use of the optional HI 740217 safety shield is strongly recommended.
DO NOT USE AN OVEN OR MICROWAVE samples may leak and generate a corrosive and possibly explosive atmosphere.
- Remove the cap from two Reagent Vials.



- Add exactly 2.0 mL of sample to one vial (sample vial), and 2.0 mL of deionized water to the other vial (blank vial), while keeping the vials at a 45-degree angle. Replace the cap tightly and mix by inverting each vial a couple of times.

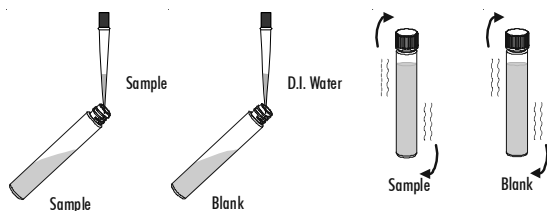

Warning: the vials will become very hot during mixing, be careful when handling them.

- Insert the vials into the reactor and heat them for 2 hours at 150°C.
- At the end of the digestion period switch off the reactor. Wait for twenty minutes to allow the vials to cool to about 120°C.
- Invert each vial several times while still warm, then place them in a test tube rack.

Warning: the vials are still hot, be careful when handling them.

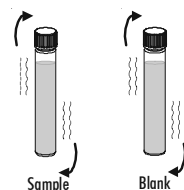

- Leave the vials in the tube rack to cool to room temperature. Do not shake or invert them, the samples may become turbid.

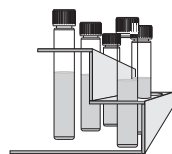

- Select the *Oxygen Demand, Chemical MR (COD)* method following one of the procedures described in the *Method Selection* section (see page 12).

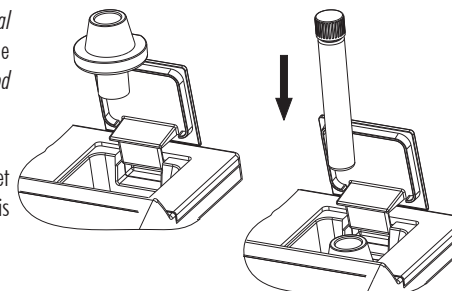

- Place the blank vial into the holder and push it completely down.
- Press the **Zero** key and the instrument will perform a zero sequence. If the zero sequence was successfully done, the display will show “-0.0-”. Now the meter is zeroed and ready for measurement.

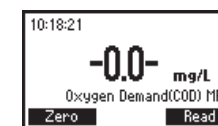
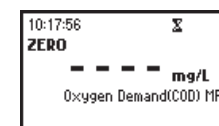
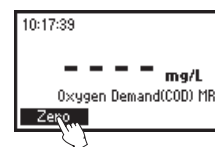

- Remove the blank vial.
- Place the sample vial into the holder and push it completely down.
- Press **Read** and the instrument will perform the reading.

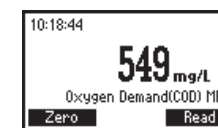
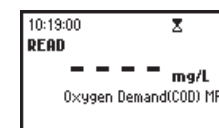
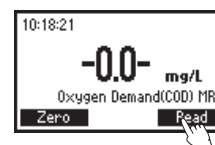

- The instrument displays concentration in **mg/L of oxygen demand** on the LCD.

INTERFERENCES

Interference may be caused by:

Chloride (Cl⁻) above 2000 mg/L.

Samples with higher chloride concentration should be diluted.

OXYGEN DEMAND, CHEMICAL LOW RANGE

SPECIFICATIONS

Range	0 to 150 mg/L COD
Resolution	1 mg/L
Accuracy	±5 mg/L or ±5 % of reading @ 25 °C, whichever is greater
Typical EMC	±1 mg/L
Deviation	
Light Source	Tungsten lamp with narrow band interference filter @ 420 nm
Method	Adaptation of the USEPA 410.4 approved method for the COD determination on surface waters and wastewaters. Oxidizable organic compounds reduce the dichromate ion (orange) to the chromic ion (green). The amount of remaining dichromate is determined.

REQUIRED REAGENTS

Description	Q.ty/test	Q.ty/set
Reagent Vial	1 vial	25 vials
Deionized Water	2.0 mL	optional

Note: Store the unused vials in their container in a cool and dark place.

REAGENT SET

HI 93754A-25 Reagents for up to 25 tests

REQUIRED ACCESSORIES

- HI 839800-01 Hanna reactor (115 VAC)
 - HI 839800-02 Hanna reactor (230 VAC)
 - HI 740216 Test tube cooling rack (25 holes)
 - HI 740217 Laboratory bench safety shield
- For other accessories see page 132.

MEASUREMENT PROCEDURE



Before using the reagent kit carefully read all the instructions and the Material Safety Data Sheet (MSDS). Pay particular attention to all warnings, cautions and notes. Failure to do so may result in serious injury to the operator.

Reagent Blank Correction: This method requires a reagent blank correction. A single blank vial may be used more than once. The blank vial is stable for several months (room temperature). For most accurate measurement, run a blank for each set of measurements and always use the same lot of reagents for blank and samples.

- Choose a homogeneous sample. Samples containing settleable solids need to be homogenized with a blender.
- Preheat the Hanna Reactor HI 839800 to 150 °C (302°F). For correct use of the reactor follow Reactor Instruction Manual.
The optional HI 740217 safety shield is strongly recommended.
DO NOT USE AN OVEN OR MICROWAVE samples may leak and generate a corrosive and possibly explosive atmosphere.
- Remove the cap from two Reagent Vials.



- Add exactly 2.0 mL of sample to one vial (sample vial), and 2.0 mL of deionized water to the other vial (blank vial), while keeping the vials at a 45-degree angle. Replace the cap tightly and mix by inverting each vial a couple of times.

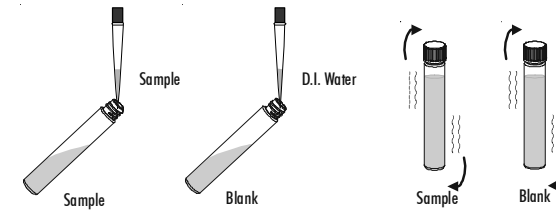

Warning: the vials will become hot during mixing, be careful when handling them.

- Insert the vials into the reactor and heat them for 2 hours at 150°C.
- At the end of the digestion period switch off the reactor. Wait for twenty minutes to allow the vials to cool to about 120°C.



- Invert each vial several times while still warm, then place them in the test tube rack.

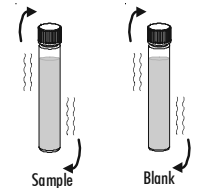

Warning: the vials are still hot, be careful when handling them.

- Leave the vials in the tube rack to cool to room temperature. Do not shake or invert them, the samples may become turbid.



- Select *Oxygen Demand, Chemical LR (COD)* method following one of the procedures described in the *Method Selection* section (see page 12).

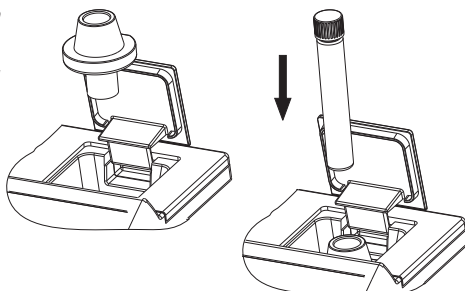

- Place the COD vial adapter in the cuvet holder and ensure that the adapter is well fit inside.
- Place the blank vial into the holder and push it completely down.
- Press the **Zero** key and the instrument will perform a zero sequence. If the zero sequence was successfully done, the display will show “-0.0-”. Now the meter is zeroed and ready for measurement.

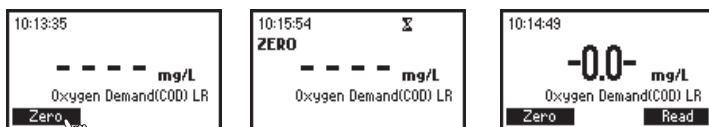

- Remove the blank vial.
- Place the sample vial into the holder and push it completely down.
- Press **Read** and the instrument will perform the reading.

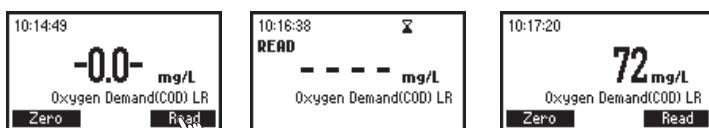

- The instrument displays concentration in **mg/L of oxygen demand**.

INTERFERENCES

Interference may be caused by:

Chloride (Cl^-) above 2000 mg/L.

Samples with higher chloride concentration should be diluted.

OZONE

SPECIFICATIONS

Range	0.00 to 2.00 mg/L
Resolution	0.01 mg/L
Accuracy	± 0.02 mg/L $\pm 3\%$ of reading at 25 °C
Typical EMC Deviation	± 0.01 mg/L
Light Source	Tungsten lamp with narrow band interference filter @ 525 nm
Method	Colorimetric DPD Method. The reaction between ozone and the DPD reagent causes a pink tint in the sample.

REQUIRED REAGENTS

Code	Description	Quantity/test
HI 93757-0	DPD Powder Reagent	1 packet
HI 93703-52-0	Glycine Powder (Optional Reagent)	1 packet

REAGENT SETS

HI 93757-01	Reagents for 100 tests
HI 93757-03	Reagents for 300 tests
HI 93703-52	Glycine Powder, Optional Reagent for 100 tests

For other accessories see page 132.

IMPORTANT NOTE: Chlorine is a strong interferent for ozone determination. If the sample is suspected to contain chlorine residues (free or total chlorine), please follow the **alternative** measurement procedure described below:

- Perform the Standard Measurement Procedure and take note of the reading: *value A*.
- On a fresh sample perform the Additional Measurement Procedure and take note of the reading: *value B*.
- Subtract reading *B* from reading *A* to obtain the ozone concentration in mg/L:
 $\text{mg/L } (\text{O}_3) = \text{value A} - \text{value B}$.

STANDARD MEASUREMENT PROCEDURE

- Select the *Ozone* method using the procedure described in the *Method Selection* section (see page 12).
- Fill the cuvette with 10 mL of unreacted sample, up to the mark, and replace the cap.
- Place the cuvette into the holder and close the lid.

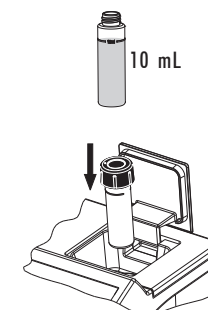

- Press the **Zero** key. The display will show “-0.0-” the meter is zeroed and ready for measurement.

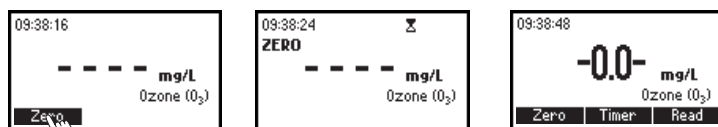

- Remove the cuvette.
- Add the content of one packet of HI 93757-0 Ozone Reagent. Replace the cap and shake gently for 20 seconds.
- Replace the cuvette into the holder and close the lid.

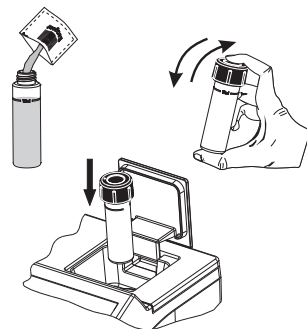

- Press **Timer** and the display will show the countdown prior to the measurement or, alternatively, wait for 2 minutes and press **Read**. When the timer ends the meter will perform the reading.



- The instrument displays concentration in **mg/L of ozone** (chlorine free samples only).



ADDITIONAL MEASUREMENT PROCEDURE

For samples containing chlorine

- Select the *Ozone* method using the procedure described in the *Method Selection* section (see page 12).
- Fill the cuvette with 10 mL of unreacted sample, up to the mark, and replace the cap.
- Place the cuvette into the holder and close the lid.

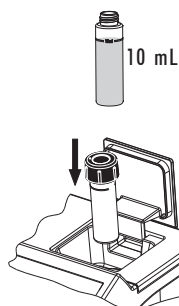

- Press the **Zero** key. The display will show “-0.0-” when the meter is zeroed and ready for measurement.

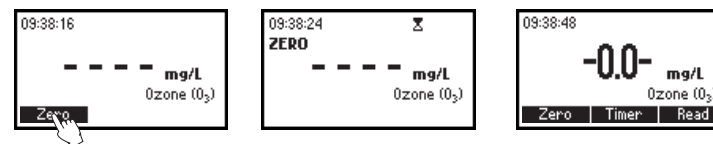

- Remove the cuvette.
- Add the content of one packet of the optional reagent HI 93703-52-0 Glycine Powder. Replace the cap and shake gently until completely dissolved.
- Add the content of one packet of HI 93757-0 Ozone Reagent. Replace the cap and shake gently for 20 seconds.

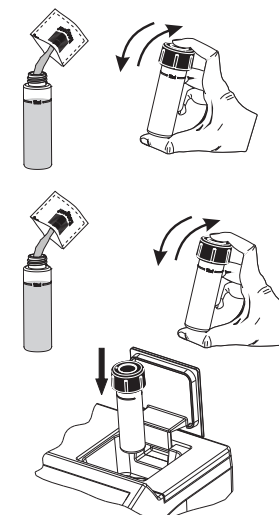

- Replace the cuvette into the holder and close the lid.
- Press **Timer** and the display will show the countdown prior to the measurement or, alternatively, wait for 2 minutes and press **Read**. When the timer ends the meter will perform the reading.



- The instrument displays a concentration value referring to chlorine interference. Subtract this value from the reading from the Standard Measurement Procedure: this will be the concentration in **mg/L of ozone** in the sample.

INTERFERENCES

Interference may be caused by: Bromine, Chlorine Dioxide, Iodine.

Alkalinity above 250 mg/L CaCO₃ will not reliably develop the full amount of color or it may rapidly fade. To resolve this, neutralize the sample with diluted HCl.

In case of water with hardness greater than 500 mg/L CaCO₃, shake the sample for approximately 2 minutes after adding the powder reagent.

pH

SPECIFICATIONS

Range	6.5 to 8.5 pH
Resolution	0.1 pH
Accuracy	±0.1 pH at 25 °C
Typical EMC Deviation	±0.1 pH
Light Source	Tungsten lamp with narrow band interference filter @ 525 nm
Method	Adaptation of the Phenol Red method. The reaction with the reagent causes a yellow to red tint in the sample.

REQUIRED REAGENTS

<u>Code</u>	<u>Description</u>	<u>Quantity</u>
HI 93710-0	Phenol Red Indicator	5 drops

REAGENT SETS

HI 93710-01 Reagents for 100 pH tests
 HI 93710-03 Reagents for 300 pH tests
 For other accessories see page 132.

MEASUREMENT PROCEDURE

- Select the *pH* method using the procedure described in the *Method Selection* section (see page 12).
- Fill the cuvette with 10 mL of unreacted sample (up to the mark) and replace the cap.



- Place the cuvette into the holder and close the lid.

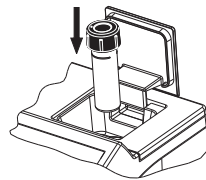

- Press the **Zero** key. The display will show “-0.0-” when the meter is zeroed and ready for measurement.

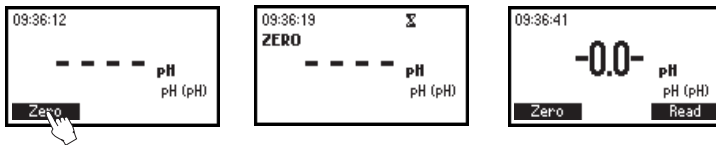

- Remove the cuvette and add 5 drops of HI 93710-0 Phenol Red Indicator. Replace the cap and mix the solution.

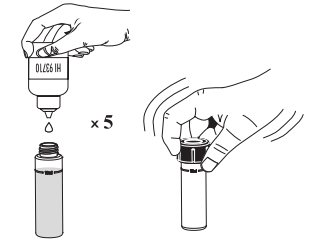

- Reinsert the cuvette into the instrument.

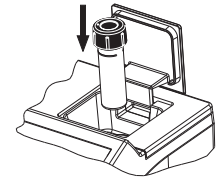

- Press the **Read** key to start the reading. The instrument displays the **pH value**.

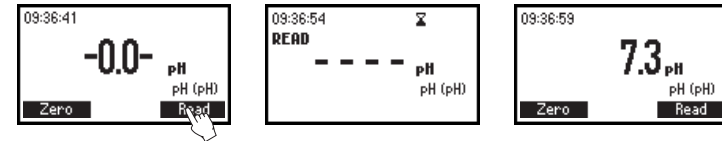

PHOSPHATE HIGH RANGE

SPECIFICATIONS

Range	0.0 to 30.0 mg/L
Resolution	0.1 mg/L
Accuracy	±1 mg/L ±4% of reading at 25 °C
Typical EMC Dev.	±0.1 mg/L
Light Source	Tungsten lamp with narrow band interference filter @ 525 nm
Method	Adaptation of the <i>Standard Methods for the Examination of Water and Wastewater, 18th edition</i> , Amino Acid method. The reaction between phosphate and reagents causes a blue tint in the sample.

REQUIRED REAGENTS

Code	Description	Quantity
HI 93717A-0	Molybdate	10 drops
HI 93717B-0	Reagent B	1 packet

REAGENT SETS

HI 93717-01 Reagents for 100 tests

HI 93717-03 Reagents for 300 tests

For other accessories see page 132.

MEASUREMENT PROCEDURE

- Select the *Phosphate HR* method using the procedure described in the *Method Selection* section (see page 12).
- Fill the cuvette with 10 mL of unreacted sample (up to the mark) and replace the cap.
- Place the cuvette into the holder and close the lid.
- Press the **Zero** key. The display will show “-0.0-” when the meter is zeroed and ready for measurement.

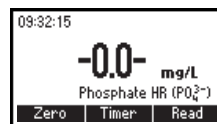
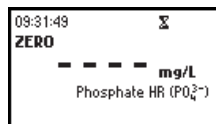
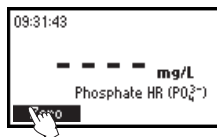
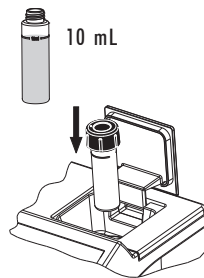

- Remove the cuvette.
- Add 10 drops of HI 93717A-0 Molybdate reagent.



- Add the content of one packet of HI 93717B-0 Phosphate HR Reagent B to the cuvette. Replace the cap and shake gently until completely dissolved.

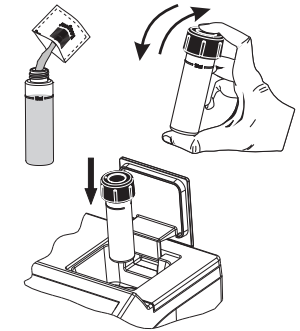

- Reinsert the cuvette into the instrument.
- Press **Timer** and the display will show the countdown prior to the measurement or, alternatively, wait for 5 minutes and press **Read**. When the timer ends the meter will perform the reading. The instrument displays the results in **mg/L of phosphate (PO₄³⁻)**.

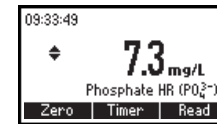
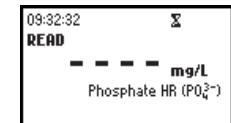
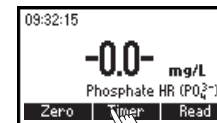

- Press **▲** or **▼** to access the second level functions.
- Press the **Chem Frm** key to convert the result in mg/L of phosphorus (P) and phosphorus pentoxide (P₂O₅).

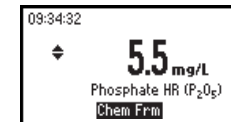
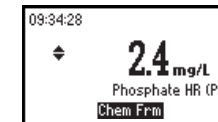
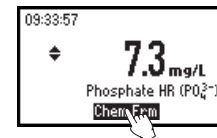

- Press **▲** or **▼** to return to the measurement screen.

INTERFERENCES

Sulfide

Chloride above 150000 mg/L

Calcium above 10000 mg/L as CaCO₃

Magnesium above 40000 mg/L as CaCO₃

Ferrous iron above 100 mg/L

PHOSPHATE LOW RANGE

SPECIFICATIONS

Range	0.00 to 2.50 mg/L
Resolution	0.01 mg/L
Accuracy	±0.04 mg/L ±4% of reading at 25 °C
Typical EMC Dev.	±0.01 mg/L
Light Source	Tungsten lamp with narrow band interference filter @ 610 nm
Method	Adaptation of the Ascorbic Acid method. The reaction between phosphate and the reagent causes a blue tint in the sample.

REQUIRED REAGENTS

Code	Description	Quantity
HI 93713-0	Powder reagent	1 packet

REAGENT SETS

HI 93713-01 Reagents for 100 tests

HI 93713-03 Reagents for 300 tests

For other accessories see page 132.

MEASUREMENT PROCEDURE

- Select the *Phosphate LR* method using the procedure described in the *Method Selection* section (see page 12).
- Rinse, cap and shake the cuvette several times with unreacted sample. Fill the cuvette with 10 mL of sample up to the mark and replace the cap.
- Place the cuvette into the holder and close the lid.

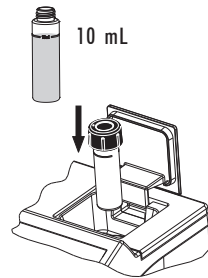

- Press the **Zero** key. The display will show “-0.0-” when the meter is zeroed and ready for measurement.

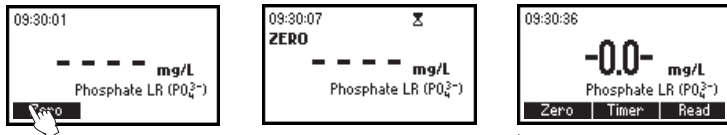

- Remove the cuvette and add the content of one packet of HI 93713-0 reagent. Replace the cap and shake gently (for about 2 minutes) until the powder is completely dissolved.

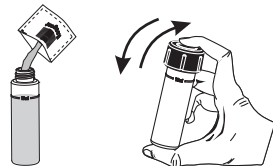

- Reinsert the cuvette into the instrument.

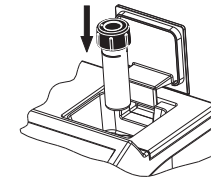

- Press **Timer** and the display will show the countdown prior to the measurement or, alternatively, wait for 3 minutes and press **Read**. When the timer ends the meter will perform the reading. The instrument displays concentration in **mg/L of phosphate (PO₄³⁻)**.

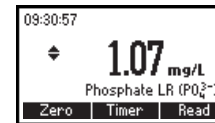
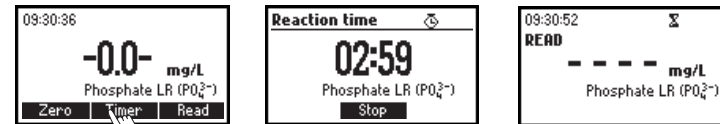

- Press **▲** or **▼** to access the second level functions.
- Press the **Chem Frm** key to convert the result in mg/L of phosphorus (P) and phosphorus pentoxide (P₂O₅).

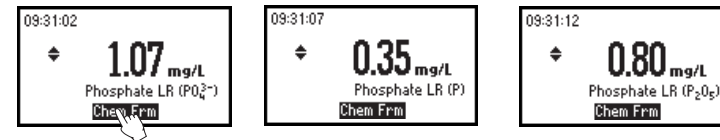

- Press **▲** or **▼** to return to the measurement screen.

INTERFERENCES

Interference may be caused by:

Iron above 50 mg/L

Silica above 50 mg/L

Silicate above 10 mg/L

Copper above 10 mg/L

Hydrogen sulfide, arsenate, turbid sample and highly buffered samples also interfere.

PHOSPHORUS

SPECIFICATIONS

Range	0.0 to 15.0 mg/L
Resolution	0.1 mg/L
Accuracy	±0.3 mg/L ±4% of reading at 25 °C
Typical EMC Dev.	±0.2 mg/L
Light Source	Tungsten lamp with narrow band interference filter @ 525 nm
Method	Adaptation of the <i>Standard Methods for the Examination of Water and Wastewater, 18th edition</i> , Amino Acid method. The reaction between phosphate and reagents causes a blue tint in the sample.

REQUIRED REAGENTS

Code	Description	Quantity
HI 93706A-0	Molybdate	10 drops
HI 93706B-0	Amino Acid Powder	1 packet

REAGENT SETS

HI 93706-01 Reagents for 100 tests

HI 93706-03 Reagents for 300 tests

For other accessories see page 132.

MEASUREMENT PROCEDURE

- Select the *Phosphorus* method using the procedure described in the *Method Selection* section (see page 12).
- Fill the cuvette with 10 mL of unreacted sample (up to the mark) and replace the cap.
- Place the cuvette into the holder and close the lid.
- Press the **Zero** key. The display will show “-0.0-” when the meter is zeroed and ready for measurement.

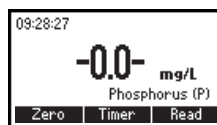
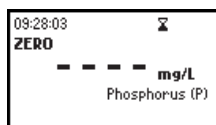
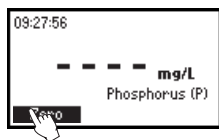
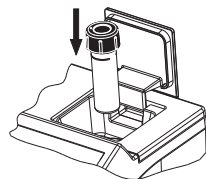

- Remove the cuvette.
- Add 10 drops of HI 93706A-0 Molybdate reagent.



- Add the content of one packet of HI 93706B-0 Phosphorus Reagent B (Amino Acid) to the cuvette. Replace the cap and shake gently until completely dissolved.

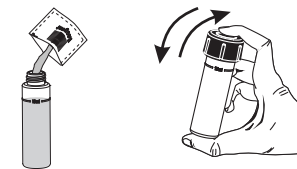

- Reinsert the cuvette into the instrument.

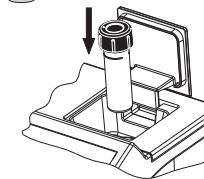

- Press **Timer** and the display will show the countdown prior to the measurement or, alternatively, wait for 5 minutes and press **Read**. When the timer ends the meter will perform the reading. The instrument displays the results in **mg/L of phosphorus (P)**.

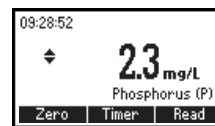
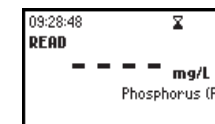
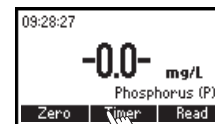

- Press **▲** or **▼** to access the second level functions.
- Press the **Chem Frm** key to convert the result in mg/L of phosphate (PO_4^{3-}) and phosphorus pentoxide (P_2O_5).

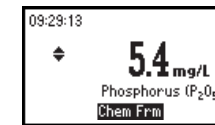
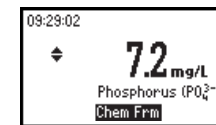
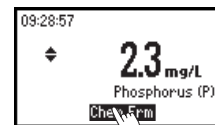

- Press **▲** or **▼** to return to the measurement screen.

INTERFERENCES

Interference may be caused by:

Sulfide

Chloride above 150000 mg/L

Calcium above 10000 mg/L as CaCO_3

Magnesium above 40000 mg/L as CaCO_3

Ferrous iron above 100 mg/L

POTASSIUM HIGH RANGE

SPECIFICATIONS

Range	20 to 200 mg/L
Resolution	5 mg/L
Accuracy	±30 mg/L ±7% of reading at 25 °C
Typical EMC	±5 mg/L
Deviation	
Light Source	Tungsten lamp with narrow band interference filter @ 610 nm
Method	Adaptation of the Turbidimetric Tetraphenylborate method. The reaction between Potassium and reagents causes turbidity in the sample.

REQUIRED REAGENTS

Code	Description	Quantity
HI 93750A-0	Potassium Reagent	6 drops
HI 93750B-0	Powder Reagent	1 packet

REAGENT SETS

HI 93750-01 Reagents for 100 tests

HI 93750-03 Reagents for 300 tests

For other accessories see page 132.

MEASUREMENT PROCEDURE

Note: for sample preparation follow the CONCENTRATED SAMPLES procedure at page 18.

- Select the *Potassium HR* method using the procedure described in the *Method Selection* section (see page 12).
- Fill the cuvette with 10 mL of sample, up to the mark.
- Add six drops of HI 93750A-0, replace the cap and swirl the solution.

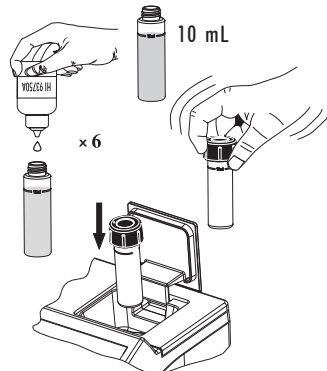

- Place the cuvette into the holder and close the lid.

- Press the **Zero** key. The display will show “-0.0-” when the meter is zeroed and ready for measurement.

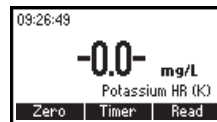
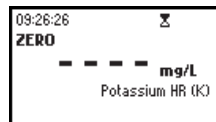
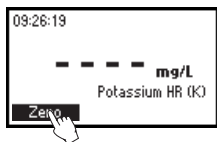

- Remove the cuvette and add the content of one packet of HI 93750B-0 reagent. Replace the cap and **gently** mix for one minute by slowly turning the cuvette upside down.

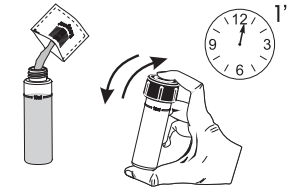

- Reinsert the cuvette into the instrument.

- Press **Timer** and the display will show the countdown prior to the measurement or, alternatively, wait for 2 minutes and press **Read**. When the timer ends the meter will perform the reading. The instrument displays the results in **mg/L (ppm) of potassium (K)**.

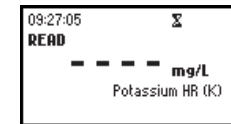
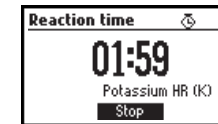
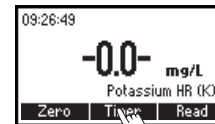
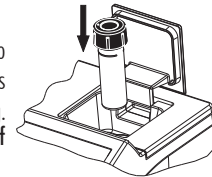

- Press **▲** or **▼** to access the second level functions.
- Press the **Chem Frm** key to convert the result in mg/L of potassium oxide (K₂O)

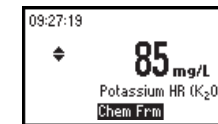
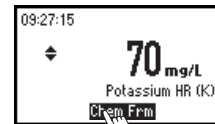

- Press **▲** or **▼** to return to the measurement screen.
- For **ULTRA HIGH RANGE** samples: follow the procedure described at page 115.

INTERFERENCES

Interferences may be caused by:
 Ammonium above 10 ppm
 Calcium above 10000 ppm as CaCO₃

Chloride above 12000 ppm
 Magnesium above 8000 ppm as CaCO₃
 Sodium above 8000 ppm

POTASSIUM ULTRA HIGH RANGE

For samples containing more than 200 ppm of Potassium: follow the sample preparation procedure described at page 18 for CONCENTRATED SAMPLES. Then add to the graduated cylinder 20 mL of the prepared sample (for HR) and fill the cylinder with demineralized water from the Demineralizer Bottle up to the 100 mL mark.

Follow the MEASUREMENT PROCEDURE at page 114. Read the result in **mg/L of potassium** on the display and multiply the reading by 5 to obtain the actual concentration of Potassium.

POTASSIUM MEDIUM RANGE

SPECIFICATIONS

Range	10 to 100 mg/L
Resolution	2.5 mg/L
Accuracy	±15 mg/L ±7% of reading at 25 °C
Typical EMC	±2.5 mg/L
Deviation	
Light Source	Tungsten lamp with narrow band interference filter @ 610 nm
Method	Adaptation of the Turbidimetric Tetraphenylborate method. The reaction between Potassium and reagents causes turbidity in the sample.

REQUIRED REAGENTS

Code	Description	Quantity
HI 93750A-0	Potassium Reagent	6 drops
HI 93750B-0	Powder Reagent	1 packet

REAGENT SETS

HI 93750-01 Reagents for 100 tests

HI 93750-03 Reagents for 300 tests

For other accessories see page 132.

MEASUREMENT PROCEDURE

Note: for sample preparation follow the CONCENTRATED SAMPLES procedure at page 18.

- Select the *Potassium MR* method using the procedure described in the *Method Selection* section (see page 12).

- Fill the cuvette with 10 mL of sample, up to the mark.

- Add six drops of HI 93750A-0, replace the cap and swirl the solution.

- Place the cuvette into the holder and close the lid.

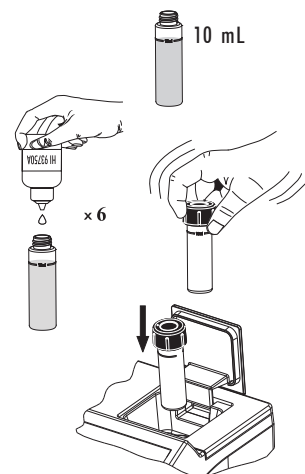

- Press the **Zero** key. The display will show “-0.0-” when the meter is zeroed and ready for measurement.

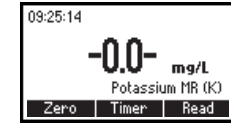
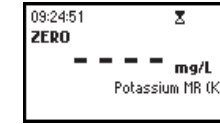
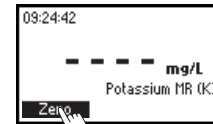

- Remove the cuvette and add the content of one packet of HI 93750B-0 reagent. Replace the cap and gently mix for one minute by slowly turning the cuvette upside down.

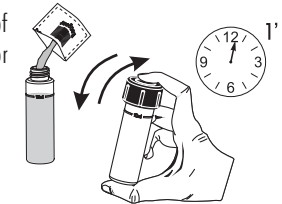

- Reinsert the cuvette into the instrument.

- Press **Timer** and the display will show the countdown prior to the measurement or, alternatively, wait for 2 minutes and press **Read**. When the timer ends the meter will perform the reading. The instrument displays the results in **mg/L (ppm) of potassium (K)**.

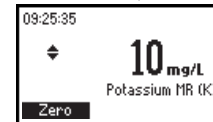
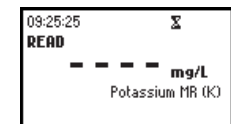
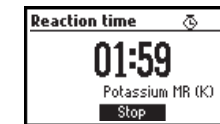
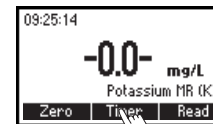
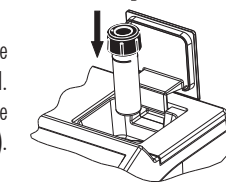

- Press **▲** or **▼** to access the second level functions.

- Press the **Chem Frm** key to convert the result in mg/L of potassium oxide (K₂O).

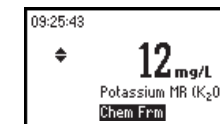
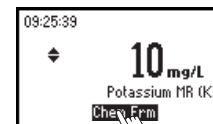

- Press **▲** or **▼** to return to the measurement screen.

INTERFERENCES

Interferences may be caused by:

Ammonium above 10 ppm

Calcium above 10000 ppm as CaCO₃

Chloride above 12000 ppm

Magnesium above 8000 ppm as CaCO₃

Sodium above 8000 ppm

POTASSIUM LOW RANGE

SPECIFICATIONS

Range	0.0 to 20.0 mg/L
Resolution	0.5 mg/L
Accuracy	±3.0 mg/L ±7% of reading at 25 °C
Typical EMC	±0.5 mg/L
Deviation	
Light Source	Tungsten lamp with narrow band interference filter @ 610 nm
Method	Adaptation of the Turbidimetric Tetraphenylborate method. The reaction between Potassium and reagents causes turbidity in the sample.

REQUIRED REAGENTS

Code	Description	Quantity
HI 93750A-0	Potassium Reagent	6 drops
HI 93750B-0	Powder Reagent	1 packet

REAGENT SETS

HI 93750-01 Reagents for 100 tests

HI 93750-03 Reagents for 300 tests

For other accessories see page 132.

MEASUREMENT PROCEDURE

Note: for sample preparation follow the COLORED OR TURBID SAMPLES procedure at page 17.

- Select the *Potassium LR* method using the procedure described in the *Method Selection* section (see page 12).

- Fill the cuvette with 10 mL of sample, up to the mark.

- Add 6 drops of HI 93750A-0 Potassium Reagent, replace the cap and swirl the solution.

- Place the cuvette into the holder and close the lid.

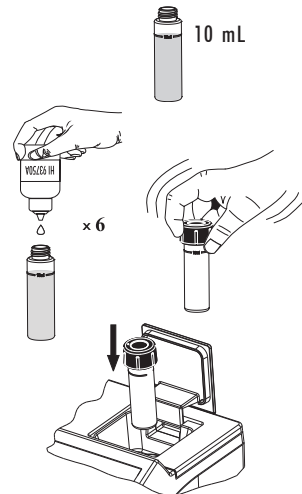

- Press the **Zero** key. The display will show “-0.0-” when the meter is zeroed and ready for measurement.

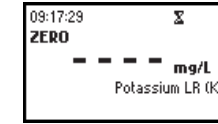
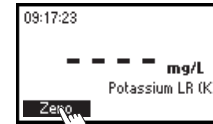

- Remove the cuvette and add the content of one packet of HI 93750B-0 reagent. Replace the cap and gently mix for one minute by slowly turning the cuvette upside down.

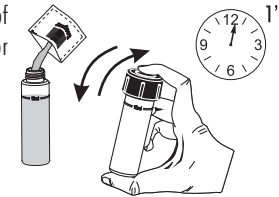

- Reinsert the cuvette into the instrument.

- Press **Timer** and the display will show the countdown prior to the measurement or, alternatively, wait for 2 minutes and press **Read**. When the timer ends the meter will perform the reading. The instrument displays the results in **mg/L (ppm) of potassium (K)**.

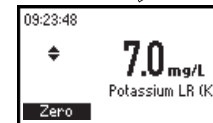
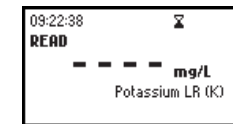
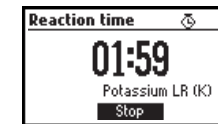
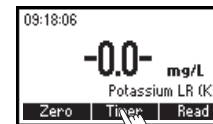
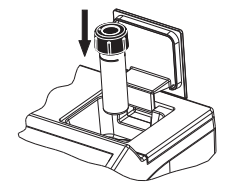

- Press **▲** or **▼** to access the second level functions.
- Press the **Chem Frm** key to convert the result in mg/L of potassium oxide (K₂O).

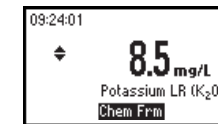
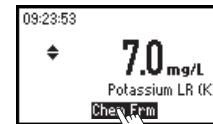

- Press **▲** or **▼** to return to the measurement screen.

INTERFERENCES

Interferences may be caused by:

Ammonium above 10 ppm

Calcium above 10000 ppm as CaCO₃

Chloride above 12000 ppm

Magnesium above 8000 ppm as CaCO₃

Sodium above 8000 ppm

SILICA

SPECIFICATIONS

Range	0.00 to 2.00 mg/L
Resolution	0.01 mg/L
Accuracy	±0.03 mg/L ±3% of reading at 25 °C
Typical EMC Deviation	±0.01 mg/L
Light Source	Tungsten lamp with narrow band interference filter @ 610 nm
Method	Adaptation of the <i>ASTM Manual of Water and Environmental Technology, D859</i> , Heteropoly Blue method. The reaction between silica and reagents causes a blue tint in the sample.

REQUIRED REAGENTS

Code	Description	Quantity
HI 93705A-0	Molybdate	6 drops
HI 93705B-0	Citric acid	1 packet
HI 93705C-0	Amino acid	1 packet

REAGENT SETS

HI 93705-01 Reagents for 100 tests

HI 93705-03 Reagents for 300 tests

For other accessories see page 132.

MEASUREMENT PROCEDURE

- Select the *Silica* method using the procedure described in the *Method Selection* section (see page 12).
- Fill the cuvette with 10 mL of unreacted sample (up to the mark).
- Add 6 drops of HI 93705A-0 Molybdate reagent. Replace the cap and swirl the solution.
- Wait for 4 minutes, add the content of one packet of HI 93705B-0 Citric acid reagent and shake until it is completely dissolved.
- Wait for 1 minute. This is the blank.
- Place the cuvette into the holder and close the lid.

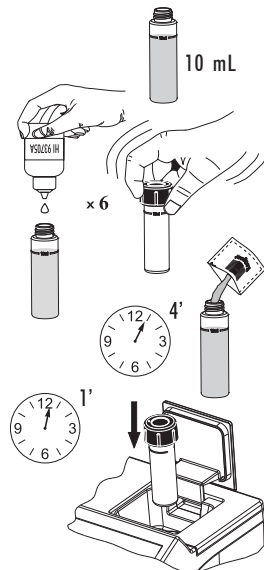

- Press the **Zero** key. The display will show “-0.0-” when the meter is zeroed and ready for measurement.

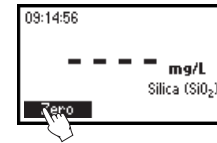

- Remove the cuvette and add the content of one packet of HI 93705C-0 Amino acid reagent and shake until it is completely dissolved.
- Reinsert the cuvette into the instrument.
- Press **Timer** and the display will show the countdown prior to the measurement. Alternatively, wait for exactly 3 minutes and press **Read**. When the timer ends the meter will perform the reading. The instrument displays concentration in **mg/L** of silica (SiO_2).

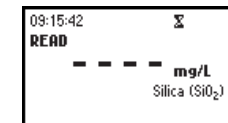
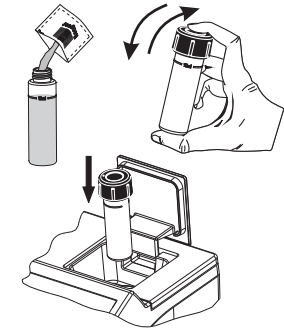

- Press **▲** or **▼** to access the second level functions.
- Press the **Chem Frm** key to convert the result in mg/L of Silicon (Si).

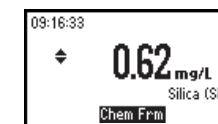
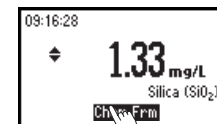

- Press **▲** or **▼** to return to the measurement screen.

INTERFERENCES

Interference may be caused by:

Phosphate above 60 mg/L

Phosphate above 75 mg/L

Sulfide and high concentration of iron

Eliminate color and turbidity interferences by zeroing the meter with the original water sample.

SILVER

SPECIFICATIONS

Range	0.000 to 1.000 mg/L
Resolution	0.005 mg/L
Accuracy	± 0.020 mg/L $\pm 5\%$ of reading at 25 °C
Typical EMC	± 0.001 mg/L
Deviation	
Light Source	Tungsten lamp with narrow band interference filter @ 575 nm.
Method	Adaptation of the PAN method. The reaction between silver and reagents causes an orange tint in the sample.

REQUIRED REAGENTS

Code	Description	Quantity
HI 93737A-0	Buffer Reagent A	1 mL
HI 93737B-0	Buffer Reagent B	1 mL
HI 93737C-0	Indicator Reagent C	2 mL
HI 93737D-0	Fixing Reagent D	2 mL
HI 93703-51	Dispersing Agent	4-6 drops

REAGENT SETS

HI 93737-01 Reagents for 50 tests

HI 93737-03 Reagents for 150 tests

For other accessories see page 132.

MEASUREMENT PROCEDURE

- Select the *Silver* method using the procedure described in the *Method Selection* section (see page 12).

Note: for best results perform your tests between 20-24°C.

- Fill two graduated beakers with 25 mL of sample.



- Add 1.0 mL of HI 93737A-0 Buffer reagent to one beaker (the blank) and swirl gently to mix.

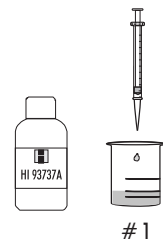

- Add exactly 1.0 mL of HI 93737B-0 Buffer reagent to the second beaker (the sample) and swirl gently to mix. Press **Timer** and the display will show the countdown prior to adding reagent C or, alternatively, wait for 2 minutes.

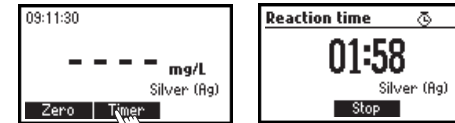

- Then add exactly 1.0 mL of HI 93737C-0 Indicator reagent to each beaker and swirl. Press **Timer** or, alternatively, wait for 2 minutes.

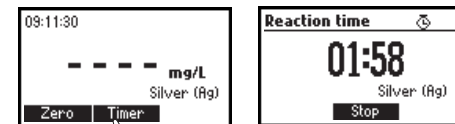

- Then, in both cases, add 1.0 mL of HI 93737D-0 Fixing reagent to each beaker and swirl. Press **Timer** or, alternatively, wait for 2 minutes.

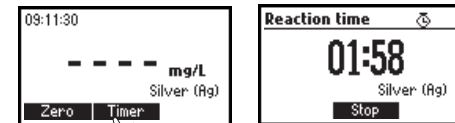

- Fill one cuvette up to the mark with 10 mL of the blank.

- Add 3 drops of Dispersing Agent (HI 93703-51), replace the cap and invert gently to mix for about 10 seconds.

- Place the cuvette into the holder and close the lid.

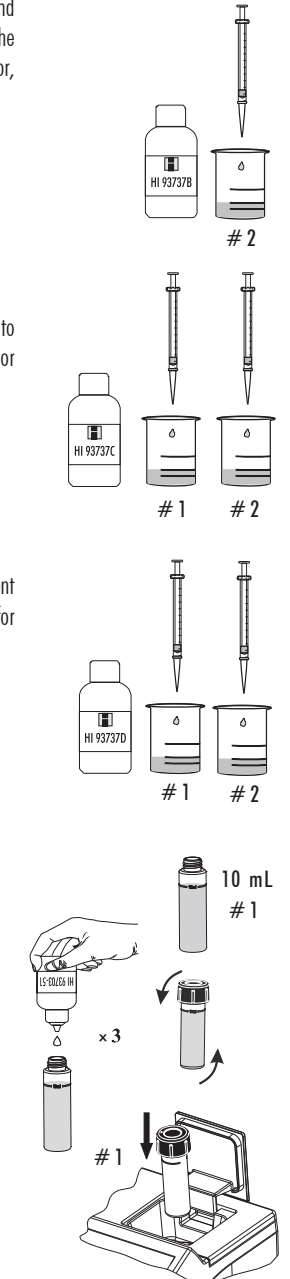

- Press the **Zero** key. The display will show “-0.0-” when the meter is zeroed and ready for measurement.

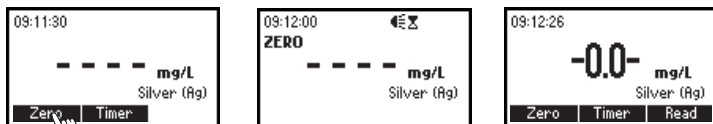

- Fill a second cuvette up to the mark with 10 mL of the reacted sample.



- Add 3 drops of Dispersing Agent (HI 93703-51), replace the cap and invert gently to mix for about 10 seconds.

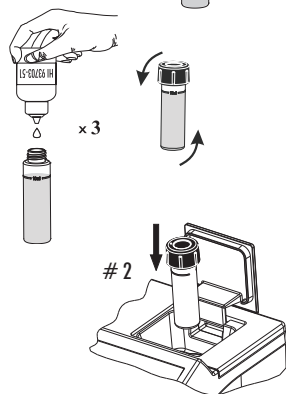

- Insert the second cuvette into the instrument.

- Press **Read** to start the reading. The instrument displays the results in mg/L of silver.

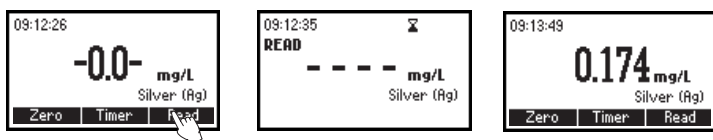

INTERFERENCES

Interference may be caused by:

Al ³⁺ above 30 mg/L	Fe ²⁺ above 1.5 mg/L
Ca ²⁺ above 1000 mg/L as CaCO ₃	Fe ³⁺ above 10 mg/L
Ca ²⁺ above 20 mg/L	K ⁺ above 500 mg/L
Cl ⁻ above 8000 mg/L	Mn ²⁺ above 25 mg/L
Co ²⁺ above 1.5 mg/L	Mg ²⁺ above 1000 mg/L as CaCO ₃
Cr ³⁺ above 20 mg/L	Na ⁺ above 5000 mg/L
Cr ⁶⁺ above 40 mg/L	Ni ²⁺ above 1.5 mg/L
Cu ²⁺ above 15 mg/L	Pb ²⁺ above 20 mg/L
F ⁻ above 20 mg/L	Zn ²⁺ above 30 mg/L

SULFATE

SPECIFICATIONS

Range	0 to 100 mg/L
Resolution	5 mg/L
Accuracy	±5 mg/L ±3% of reading at 25 °C
Light Source	Tungsten lamp with narrow band interference filter @ 466 nm
Method	Sulfate is precipitated with barium chloride crystals. Light absorbance of the suspension is measured.

REQUIRED REAGENTS

Code	Description	Quantity
HI 93751-0	Indicator reagent	1 packet

REAGENT SETS

HI 93751-01 Reagents for 100 tests

HI 93751-03 Reagents for 300 tests

For other accessories see page 132.

MEASUREMENT PROCEDURE

Note: for sample preparation follow the COLORED OR TURBID SAMPLES procedure on page 17.

- Select the *Sulfate* method using the procedure described in the *Method Selection* section (see page 12).

- Fill a cuvette with 10 mL of unreacted sample (up to the mark) and replace the cap.

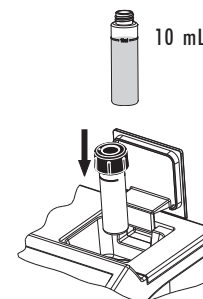

- Place the cuvette into the holder and close the lid.

- Press the **Zero** key. The display will show “-0.0-” when the meter is zeroed and ready for measurement.

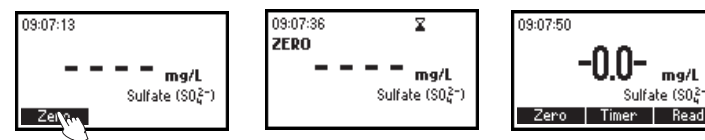

- Remove the cuvette.

- Add the content of one packet of HI 93751-0 Indicator reagent.
- Replace the cap and invert gently to mix for 1 minute (about 30 inversions).
- Reinsert the cuvette into the instrument.

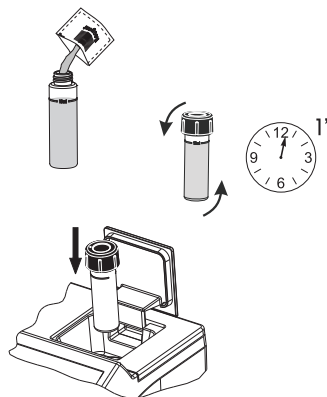

- Press **Timer** and the display will show the countdown prior to the measurement or, alternatively, wait for 5 minutes and press **Read**. When the timer ends the meter will perform the reading.



- The instrument displays concentration in **mg/L** of Sulfate (SO₄²⁻).



INTERFERENCES

Interferences may be caused by:

Calcium (as CaCO₃) above 20000 mg/L

Chloride (as Cl⁻) above 40000 mg/L

Magnesium (as MgCO₃) above 10000 mg/L

Silica (as SiO₂) above 500 mg/L

Color or suspended matter in large amounts will interfere: suspended matter should be removed by previous filtration.

Organic matter in large amounts may impede the precipitation of barium sulfate.

ZINC

SPECIFICATIONS

Range	0.00 to 3.00 mg/L
Resolution	0.01 mg/L
Accuracy	±0.03 mg/L ±3% of reading at 25 °C
Typical EMC Deviation	±0.01 mg/L
Light Source	Tungsten lamp with narrow band interference filter @ 575 nm
Method	Adaptation of the <i>Standard Methods for the Examination of Water and Wastewater, 18th edition</i> , Zincon method. The reaction between zinc and the reagents causes an orange to a dark violet tint in the sample.

REQUIRED REAGENT

<u>Code</u>	<u>Description</u>	<u>Quantity</u>
HI 93731A-0	Zinc Reagent	1 packet
HI 93731B-0	Cyclohexanone	0.5 mL

REAGENT SETS

HI 93731-01 Reagents for 100 tests

HI 93731-03 Reagents for 300 tests

For other accessories see page 132.

MEASUREMENT PROCEDURE

- Select the *Zinc* method using the procedure described in the *Method Selection* section (see page 12).
- Fill one graduated mixing cylinder up to the 20 mL mark with the sample.
- Add the content of one packet of HI 93731A-0 Zinc reagent, close the cylinder and invert several times to mix until completely dissolved.

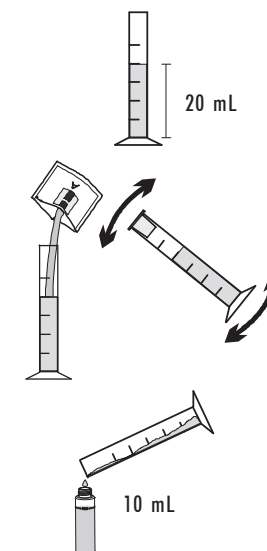

- Fill one cuvette with 10 mL of the reacted sample up to the mark.

- Place the cap and insert the cuvette into the instrument and close the lid.
- Press the **Zero** key. The display will show “-0.0-” when the meter is zeroed and ready for measurement.

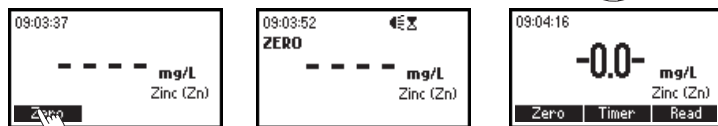
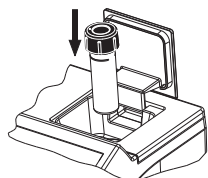

- Remove the cuvette and add 0.5 mL of HI 93731B-0 Cyclohexanone to the cuvette.

Note: To prevent any contamination from the polycarbonate cap, prior to replacing it, close the sample cuvette with the supplied HDPE plastic stopper.

- Replace the cap and mix the sample for 15 seconds.
- Insert the sample into the instrument.

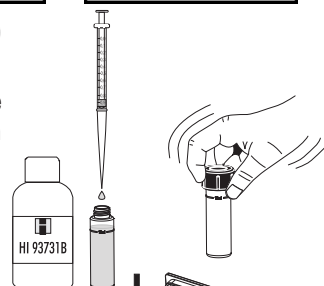

- Press **Timer** and the display will show the countdown prior to the measurement or, alternatively, wait for 3 minutes and 30 seconds and press **Read**. When the timer ends the meter will perform the reading.

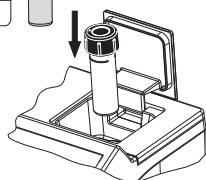

- The instrument displays the results in mg/L of zinc.

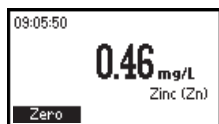

INTERFERENCES

Interference may be caused by:

- Aluminum above 6 mg/L
- Cadmium above 0.5 mg/L
- Copper above 5 mg/L
- Iron above 7 mg/L
- Manganese above 5 mg/L
- Nickel above 5 mg/L

ERRORS AND WARNINGS

The instrument shows clear warning messages when erroneous conditions appear and when measured values are outside the expected range. These messages are described below.



No Light: The light source is not functioning properly.



Light Leak: There is an excess amount of ambient light reaching the detector.



Inverted cuvettes: The sample and the zero cuvettes are inverted.



Battery Low: The battery capacity is lower than 10%.



Light Low: The instrument cannot adjust the light level. Please check that the sample does not contain any debris.



Light High: There is too much light to perform a measurement. Please check the preparation of the zero cuvette.

DATA MANAGEMENT

The analyzed data can be managed using Hanna's product HI92000, Windows® Compatible Software.

The screenshot shows the Hanna Instruments HI92000 software interface. At the top, it displays the current measurement: 0.96 mg/L Free chlorine. Below this is a data table with columns for Date, Time, Conc., Unit, Parameter, Absorbance, Instr. ID, and Instr. Serial No. The table contains three rows of data for Free chlorine measurements on 2007/06/19. The interface also includes buttons for Settings, Disconnect, Auto Log, Log Sample, and Exit, and a menu bar with options like Open, Print, Save, Export, Clear, Plot, Help, and About.

	Date	Time	Conc.	Unit	Parameter	Absorbance	Instr. ID	Instr. Serial No.
1	2007/06/19	10.04.12	0.95	mg/L	Free chlorine	0.4915167	0007	83414201XA6
2	2007/06/19	10.04.43	0.95	mg/L	Free chlorine	0.4919497	0007	83414201XA6
3	2007/06/19	10.05.03	0.96	mg/L	Free chlorine	0.4924213	0007	83414201XA6
4								
5								
6								
7								
8								
9								
10								
11								
12								
13								
14								
15								
16								
17								

Windows® is registered Trademark of "Microsoft Co."

STANDARD METHODS

Description	Range	Method
Aluminum	0.00 to 1.00 mg/L	Aluminon
Alkalinity	0 to 500 mg/L	Colorimetric
Ammonia MR	0.00 to 10.00 mg/L	Nessler
Ammonia LR	0.00 to 3.00 mg/L	Nessler
Bromine	0.00 to 8.00 mg/L	DPD
Calcium	0 to 400 mg/L	Oxalate
Chlorine, Free	0.00 to 2.50 mg/L	DPD
Chlorine, Total	0.00 to 3.50 mg/L	DPD
Chlorine Dioxide	0.00 to 2.00 mg/L	Chlorophenol Red
Chromium VI HR	0 to 1000 µg/L	Diphenylcarbohydrazide
Chromium VI LR	0 to 300 µg/L	Diphenylcarbohydrazide
Color of Water	0 to 500 PCU	Colorimetric Platinum Cobalt
Copper HR	0.00 to 5.00 mg/L	Bicinchoninate
Copper LR	0 to 1000 µg/L	Bicinchoninate
Cyanuric Acid	0 to 80 mg/L	Turbidimetric
Fluoride	0.00 to 2.00 mg/L	SPADNS
Calcium Hardness	0.00 to 2.70 mg/L	Colorimetric
Magnesium Hardness	0.00 to 2.00 mg/L	Colorimetric
Hydrazine	0 to 400 µg/L	p-Dimethylaminobenzaldehyde
Iodine	0.0 to 12.5 mg/L	DPD
Iron HR	0.00 to 5.00 mg/L	Phenanthroline
Iron LR	0 to 400 µg/L	TPTZ
Magnesium	0 to 150 mg/L	Calmagite
Manganese HR	0.0 to 20.0 mg/L	Periodate Oxidation
Manganese LR	0 to 300 µg/L	PAN
Molybdenum	0.0 to 40.0 mg/L	Mercaptoacetic Acid
Nickel HR	0.00 to 7.00 g/L	Photometric
Nickel LR	0.000 to 1.000 mg/L	PAN
Nitrate	0.0 to 30.0 mg/L	Cadmium Reduction
Nitrite HR	0 to 150 mg/L	Ferrous Sulfate
Nitrite LR	0.00 to 1.15 mg/L	Diazotization
Oxygen, Dissolved	0.0 to 10.0 mg/L	Winkler
COD HR	0 to 15000 mg/L	Dichromate, Mercuric Sulfate
COD MR	0 to 1500 mg/L	Dichromate, Mercuric Sulfate
COD LR	0 to 150 mg/L	Dichromate, Mercuric Sulfate
Ozone	0.00 to 2.00 mg/L	DPD
pH	6.5 to 8.5 pH	Phenol Red
Phosphate HR	0.0 to 30.0 mg/L	Amino Acid
Phosphate LR	0.00 to 2.50 mg/L	Ascorbic Acid

Phosphorus	0.0 to 15.0 mg/L	Amino Acid
Potassium HR	20 to 200 mg/L	Turbidimetric
Potassium MR	10 to 100 mg/L	Turbidimetric
Potassium LR	0.0 to 20.0 mg/L	Turbidimetric
Silica	0.00 to 2.00 mg/L	Heteropoly Blue
Silver	0.000 to 1.000 mg/L	PAN
Sulfate	0 to 100 mg/L	Turbidimetric
Zinc	0.00 to 3.00 mg/L	Zincon

ACCESSORIES

REAGENT SETS

HI 93700-01	100 ammonia LR tests
HI 93700-03	300 ammonia LR tests
HI 93701-01	100 free chlorine tests (powder)
HI 93701-03	300 free chlorine tests (powder)
HI 93701-F	300 free chlorine tests (liquid)
HI 93701-T	300 total chlorine tests (liquid)
HI 93702-01	100 copper HR tests
HI 93702-03	300 copper HR tests
HI 93704-01	100 hydrazine tests
HI 93704-03	300 hydrazine tests
HI 93705-01	100 silica tests
HI 93705-03	300 silica tests
HI 93706-01	100 phosphorus tests
HI 93706-03	300 phosphorus tests
HI 93707-01	100 nitrite LR tests
HI 93707-03	300 nitrite LR tests
HI 93708-01	100 nitrite HR tests
HI 93708-03	300 nitrite HR tests
HI 93709-01	100 manganese HR tests
HI 93709-03	300 manganese HR tests
HI 93710-01	100 pH tests
HI 93710-03	300 pH tests
HI 93711-01	100 total chlorine tests (powder)
HI 93711-03	300 total chlorine tests (powder)
HI 93712-01	100 aluminum tests
HI 93712-03	300 aluminum tests
HI 93713-01	100 phosphate LR tests
HI 93713-03	300 phosphate LR tests
HI 93715-01	100 ammonia MR tests
HI 93715-03	300 ammonia MR tests
HI 93716-01	100 bromine tests
HI 93716-03	300 bromine tests

HI 93717-01	100 phosphate HR tests
HI 93717-03	300 phosphate HR tests
HI 93718-01	100 iodine tests
HI 93718-03	300 iodine tests
HI 93719-01	100 Mg hardness tests
HI 93719-03	300 Mg hardness tests
HI 93720-01	100 Ca hardness tests
HI 93720-03	300 Ca hardness tests
HI 93721-01	100 iron HR tests
HI 93721-03	300 iron HR tests
HI 93722-01	100 cyanuric acid tests
HI 93722-03	300 cyanuric acid tests
HI 93723-01	100 chromium VI HR tests
HI 93723-03	300 chromium VI HR tests
HI 93726-01	100 nickel HR tests
HI 93726-03	300 nickel HR tests
HI 93728-01	100 nitrate tests
HI 93728-03	300 nitrate tests
HI 93729-01	100 fluoride tests
HI 93729-03	300 fluoride tests
HI 93730-01	100 molybdenum tests
HI 93730-03	300 molybdenum tests
HI 93731-01	100 zinc tests
HI 93731-03	300 zinc tests
HI 93732-01	100 dissolved oxygen tests
HI 93732-03	300 dissolved oxygen tests
HI 93737-01	50 silver tests
HI 93737-03	150 silver tests
HI 93738-01	100 chlorine dioxide tests
HI 93738-03	300 chlorine dioxide tests
HI 93740-01	50 nickel LR tests
HI 93740-03	150 nickel LR tests
HI 93746-01	50 iron LR tests
HI 93746-03	150 iron LR tests
HI 93748-01	50 manganese LR tests
HI 93748-03	150 manganese LR tests
HI 93749-01	100 chromium VI LR tests
HI 93749-03	300 chromium VI LR tests
HI 93754A-25	25 COD, LR EPA*, Dichromate Method test
HI 93754B-25	25 COD, MR EPA*, Dichromate Method test
HI 93754C-25	25 COD, HR, Dichromate Method test
HI 93754D-25	25 COD, LR, Dichromate Method, Mercury Free test
HI 93754E-25	25 COD, MR, Dichromate Method Mercury Free test

HI 93754F-25	25 COD, LR ISO, Dichromate Method test
HI 93754G-25	25 COD, MR ISO**, Dichromate Method test
HI 93755-01	100 alkalinity tests
HI 93755-03	300 alkalinity tests
HI 93755-53	Chlorine Remover
HI 937521-01	50 calcium tests
HI 937521-03	150 calcium tests
HI 937520-01	50 magnesium tests
HI 937520-03	150 magnesium tests
HI 93757-01	100 ozone tests
HI 93757-03	300 ozone tests
HI 93703-52-2	Glycine Powder, Optional Reagent for 100 tests
HI 93750-01	100 potassium HR tests
HI 93750-03	300 potassium HR tests
HI 93751-01	100 sulfate tests
HI 93751-03	300 sulfate tests
HI 95747-01	100 copper LR tests
HI 95747-03	300 copper LR tests

OTHER ACCESSORIES

HI 731318	cloth for wiping cuvettes (4 pcs)
HI 731321	glass cuvettes (4 pcs)
HI 731325W	new cap for cuvette (4 pcs)
HI 740034	cap for 100 mL beaker (6 pcs)
HI 740036	100 mL plastic beaker (6 pcs)
HI 740038	60 mL glass bottle and stopper
HI 740142	1 mL graduated syringe
HI 740143	1 mL graduated syringe (6 pcs)
HI 740144	pipette tip (6 pcs)
HI 740157	plastic refilling pipette (20 pcs)
HI 740220	25 mL glass cylinders with caps (2 pcs)
HI 740223	170 mL plastic beaker
HI 740224	170 mL plastic beakers (12 pcs)
HI 740225	60 mL graduated syringe
HI 740226	5 mL graduated syringe
HI 740227	filter assembly
HI 740228	filter discs (25 pcs)
HI 740229	100 mL graduated cylinder
HI 740230	230 mL demineralized water
HI 740235	COD adapter
HI 92000	Windows compatible software
HI 920013	PC connection cable
HI 93703-50	cuvette cleaning solution (230 mL)
HI 93703-54	dried resin (100 g)
HI 93703-55	activated carbon (50 pcs)

WARRANTY

All Hanna Instruments meters are warranted for two years against defects in workmanship and materials when used for its intended purpose and maintained according to the instructions.

This warranty is limited to repair or replacement free of charge.

Damages due to accident, misuse, tampering or lack of prescribed maintenance are not covered.

If service is required, contact your dealer. If under warranty, report the model number, date of purchase, serial number and the nature of the failure. If the repair is not covered by the warranty, you will be notified of the charges incurred.

If the instrument is to be returned to Hanna Instruments, first obtain a Returned Goods Authorization Number from the Customer Service Department and then send it with shipment costs prepaid. When shipping any instrument, make sure it is properly packaged for complete protection.

To validate your warranty, fill out and return the enclosed warranty card within 14 days from the date of purchase.

Recommendations for Users

Before using these products, make sure that they are entirely suitable for your specific application and for the environment in which they are used.

Operation of these instruments may cause unacceptable interferences to other electronic equipments, this requiring the operator to take all necessary steps to correct interferences.

Any variation introduced by the user to the supplied equipment may degrade the instruments' EMC performance.

To avoid damages or burns, do not put the instrument in microwave ovens. For yours and the instrument safety do not use or store the instrument in hazardous environments.

Hanna Instruments reserves the right to modify the design, construction and appearance of its products without advance notice.

HANNA LITERATURE

Hanna publishes a wide range of catalogs and handbooks for an equally wide range of applications. The reference literature currently covers areas such as:

- Water Treatment
- Process
- Swimming Pools
- Agriculture
- Food
- Laboratory

and many others. New reference material is constantly being added to the library.

For these and other catalogs, handbooks and leaflets contact your dealer or the Hanna Customer Service Center nearest to you. To find the Hanna Office in your vicinity, check our home page at www.hannainst.com.



Hanna Instruments Inc.
Highland Industrial Park
584 Park East Drive
Woonsocket, RI 02895 USA

Technical Support for Customers
Tel. (800) 426 6287
Fax (401) 765 7575
E-mail tech@hannainst.com
www.hannainst.com

Local Sales and Customer Service Office

