



INSTRUMENTS

Gas Tracer Operator's Manual

Part Number: 71-0336

Revision: E

Released: 4/14/17

www.rkiinstruments.com

WARNING

Read and understand this instruction manual before operating instrument. Improper use of the gas monitor could result in bodily harm or death.

Periodic calibration and maintenance of the gas monitor is essential for proper operation and correct readings. Please calibrate and maintain this instrument regularly! Frequency of calibration depends upon the type of use you have and the sensor types. Typical calibration frequencies for most applications are between 1 and 3 months, but can be required more often or less often based on your usage.

Warranty

RKI Instruments, Inc. warrants the Gas Tracer sold by us to be free from defects in materials, workmanship, and performance for a period of two years from the date of shipment from RKI Instruments, Inc. This includes the instrument and the original sensors.

Replacement parts are warranted for 1 year from the date of their shipment from RKI Instruments, Inc. except for replacement sensors which are warranted for 2 years. Any parts found defective within their warranty period will be repaired or replaced, at our option, free of charge. This warranty does not apply to those items which by their nature are subject to deterioration or consumption in normal service, and which must be cleaned, repaired, or replaced on a routine basis. Examples of such items are:

Absorbent cartridges

Filter elements, disks, or sheets

Pump diaphragms and valves

Warranty is voided by abuse including mechanical damage, alteration, rough handling, or repair procedures not in accordance with the instruction manual. This warranty indicates the full extent of our liability, and we are not responsible for removal or replacement costs, local repair costs, transportation costs, or contingent expenses incurred without our prior approval.

THIS WARRANTY IS EXPRESSLY IN LIEU OF ANY AND ALL OTHER WARRANTIES AND REPRESENTATIONS, EXPRESSED OR IMPLIED, AND ALL OTHER OBLIGATIONS OR LIABILITIES ON THE PART OF RKI INSTRUMENTS, INC. INCLUDING BUT NOT LIMITED TO THE WARRANTY OF MERCHANTABILITY OR FITNESS FOR A PARTICULAR PURPOSE. IN NO EVENT SHALL RKI INSTRUMENTS, INC. BE LIABLE FOR INDIRECT, INCIDENTAL, OR CONSEQUENTIAL LOSS OR DAMAGE OF ANY KIND CONNECTED WITH THE USE OF ITS PRODUCTS OR FAILURE OF ITS PRODUCTS TO FUNCTION OR OPERATE PROPERLY.

This warranty covers instruments and parts sold to users only by authorized distributors, dealers, and representatives as appointed by RKI Instruments, Inc.

We do not assume indemnification for any accident or damage caused by the operation of this gas monitor and our warranty is limited to replacement of parts or our complete goods.

Table of Contents

Chapter 1: Introduction	1
Overview	1
About the Gas Tracer	1
Specifications	3
About This Manual	4
Chapter 2: Description	5
Overview	5
Instrument Description	5
<i>Case</i>	6
<i>Sensors</i>	6
<i>LCD</i>	9
<i>Control Buttons</i>	9
<i>Printed Circuit Boards</i>	9
<i>Alarm LED Arrays</i>	9
<i>Infrared Communications Port</i>	9
<i>Buzzer</i>	10
<i>Vibrator</i>	10
<i>Batteries</i>	10
<i>Pump</i>	11
<i>Flow Chamber</i>	11
<i>Sensors and Filters</i>	11
<i>Inlet Filter Holder</i>	12
Standard Accessories	12
<i>Tapered Rubber Nozzle</i>	12
<i>Belt Clip</i>	12
<i>Wrist Strap</i>	12
<i>Sample Hose & 10 Inch Probe</i>	12
Optional Accessories	13
<i>Charging Stations</i>	13
<i>Optional Probes</i>	15
<i>Purge Tee Fitting</i>	18
<i>External Dilution Fitting</i>	18
<i>Humidifier Tube</i>	18

Chapter 3: Using the Gas Tracer in Normal Mode	20
Overview	20
Start Up, Normal Mode	20
<i>Turning On the Gas Tracer, Normal Mode Only.</i>	20
<i>Turning On the Gas Tracer in Normal With All Modes Active</i>	26
<i>Performing a Fresh Air Adjustment, Normal Mode.</i>	28
<i>Turning Off the Gas Tracer, Normal Mode</i>	29
Measuring Mode, Normal Operation	29
<i>Monitoring an Area.</i>	29
<i>Using Optional Probes and Fittings.</i>	30
<i>Combustible Gas Detection.</i>	32
<i>CO with H₂S Response Configuration</i>	34
<i>Snap Log Mode, Normal Operation</i>	35
Measuring Mode, Alarms	38
<i>Alarm Indications</i>	38
<i>Resetting and Silencing Alarms</i>	40
<i>Responding to Alarms.</i>	41
Inert Mode	44
<i>Alarms</i>	44
<i>Start Up and Operation.</i>	44
Display Mode.	45
<i>HC Range Screen.</i>	46
<i>Peak Screen</i>	47
<i>STEL Screen</i>	47
<i>TWA Screen.</i>	48
<i>Alarm Points Screen</i>	48
<i>Operation Time Screen</i>	50
<i>Date/Time Screen</i>	50
<i>Remaining Log Time Screen</i>	53
<i>Clear Data Logger Screens</i>	51
<i>Pump Off Screen</i>	53
<i>User ID Screen</i>	53
<i>Station ID Screen</i>	54
<i>Snap Logging Screen.</i>	56
<i>Peak Bar Select Screen.</i>	59
Datalogging	60
SDM-2012	61

Calibration Mode	61
<i>Calibration/Bump Test Supplies and Equipment</i>	61
<i>Preparing for Calibration or Bump Test</i>	62
<i>Calibrating the Gas Tracer</i>	63
<i>Bump Testing the Gas Tracer</i>	71
<i>Calibrating and Bump Testing the PPM Combustible Sensor</i>	76
Chapter 4: Using the Gas Tracer in Bar Hole Mode	88
Overview	88
Start Up, Bar Hole Mode	88
<i>Turning On the Gas Tracer, Bar Hole Mode</i>	88
<i>Performing a Fresh Air Adjustment, Bar Hole Mode</i>	94
Bar Hole Testing	94
<i>Performing a Bar Hole Test</i>	95
<i>Turning Off the Gas Tracer, Bar Hole Mode</i>	97
Chapter 5: Using the Gas Tracer in Leak Check Mode	98
Overview	98
Start Up, Leak Check Mode	98
<i>Turning on the Gas Tracer, Leak Check Mode</i>	98
<i>Performing a Fresh Air Adjustment, Leak Check Mode</i>	104
Leak Testing	105
<i>Setting the Display Range Value</i>	105
<i>Locating a Leak</i>	106
<i>Overscale Conditions</i>	107
<i>Turning the Alarm On and Off in Leak Check Mode</i>	107
<i>Peak Hold Mode</i>	108
<i>Snap Log Mode, Leak Check Mode Operation</i>	109
<i>Viewing Snap Log Data in Leak Check Mode Operation</i>	112
<i>Turning Off the Gas Tracer, Leak Check Mode</i>	114
Chapter 6: Maintenance Mode	115
Overview	115
Tips for Using Maintenance Mode	116
Using Maintenance Mode	116
<i>Updating the Date and Time Settings</i>	118
<i>Performing a Fresh Air Adjustment</i>	119

<i>Calibrating Using Auto Calibration</i>	120
<i>Calibration Using Single Calibration</i>	123
<i>Performing a Bump Test</i>	126
<i>Calibrating and Bump Testing the PPM Combustible Sensor</i>	132
<i>Turning the Lunch Break Setting On or Off</i>	142
<i>Updating the Alarm Latching Settings</i>	143
<i>Updating the Alarm Silence Settings</i>	144
<i>Updating the Data Logging Interval</i>	145
<i>Updating the Alarm Point Settings</i>	146
<i>Turning the Clear Data Logger Screen On or Off</i>	150
<i>Turning the Bump Test Function On or Off</i>	151
<i>Turning the Pump Off Screen On or Off</i>	151
<i>Updating the Bump Test Parameters</i>	152
<i>Updating the Confirmation Beep Setting</i>	154
<i>Updating the DataLog Overwrite Setting</i>	154
<i>Updating the Calibration Interval</i>	155
<i>Updating the Calibration Reminder Setting</i>	156
<i>Updating the Calibration Expired Action Setting</i>	156
<i>Updating the Calibration Check Setting</i>	157
<i>Updating the Bump Test Interval</i>	158
<i>Updating the Bump Test Reminder Setting</i>	159
<i>Updating the Bump Test Expired Action Setting</i>	159
<i>Updating the Bump Test Check Setting</i>	160
<i>Turning the ID Display Function On or Off</i>	161
<i>Updating the LCD Backlight Time Setting</i>	161
<i>Updating the Autozero Function</i>	162
<i>Updating the Demand Zero Function</i>	162
<i>Updating the Leak Check/Bar Hole Mode Setting</i>	163
<i>Updating the Bar Hole Sampling Time</i>	165
<i>Updating the Leak Check Mode CO Display Setting</i>	165
<i>Viewing the ROM/SUM Information</i>	166
<i>Turning the Password Function On or Off</i>	167
<i>Performing a Low Flow Setpoint Adjustment</i>	168
<i>Exiting Maintenance Mode</i>	169

Chapter 7: Maintenance 170

Overview	170
Troubleshooting	170

Replacing or Recharging the Batteries	173
<i>Replacing Alkaline Batteries</i>	173
<i>Replacing the Lithium Ion Battery Pack</i>	174
<i>Recharging the Lithium Ion Battery Pack in the Instrument</i>	175
<i>Recharging the Lithium Ion Battery Pack Out of the Instrument</i>	177
Replacing the LEL and CO Filters	180
Replacing a Sensor	182
Replacing the Hydrophobic Disk Filter, Cotton Filter, and Wire Mesh Disk	184
Parts List	186

Appendix A: Calibrating with a Sample Bag 189

Overview	189
Calibration Supplies & Equipment	189
Preparing for Calibration or Bump Test	190
<i>Normal Operation Fresh Air Adjustment</i>	190
<i>Filling the Gas Bag</i>	191
Calibrating the Gas Tracer	192
<i>Calibrating with the Auto Calibration Method</i>	193
<i>Calibrating with the Single Calibration Method</i>	197
Bump Testing	200
Calibrating and Bump Testing the PPM Combustible Sensor	207
<i>Performing a Fresh Air Adjustment</i>	208
<i>Performing an Auto Calibration</i>	209
<i>Performing a Single Calibration</i>	212
<i>Performing a Bump Test</i>	213
Parts List	219

WARNING: Understand manual before operating. Substitution of components may impair intrinsic safety. To prevent ignition of a hazardous atmosphere, batteries must only be changed or charged in an area known to be nonhazardous. Not tested in oxygen enriched atmospheres (above 21%).

Chapter 1: Introduction

Overview

This chapter briefly describes the Gas Tracer. This chapter also describes the *Gas Tracer Operator's Manual* (this document). Table 1 at the end of this chapter lists the specifications for the Gas Tracer.

About the Gas Tracer

Using an advanced detection system consisting of up to five gas sensors, the Gas Tracer sample draw gas monitor detects the presence of combustible gas, oxygen (O₂), and carbon monoxide (CO) simultaneously. The Gas Tracer's compact size and easy-to-use design makes it ideally suited for a wide range of applications, including sewage treatment plants, utility manholes, tunnels, hazardous waste sites, power stations, petrochemical refineries, mines, paper mills, drilling rigs, and fire fighting stations. The Leak Check Mode allows you to pinpoint gas leaks. The Gas Tracer offers a full range of features, including:

- Simultaneous three-gas monitoring of combustible gases, O₂, and CO (in Normal Mode)
- Choice of three operating modes: Normal Mode for typical confined space or area monitoring, Bar Hole Mode for checking of bar holes when searching for underground gas leaks, and Leak Check Mode for pinpointing gas leaks
- Sample-drawing pump with up to 50-foot range
- Liquid crystal display (LCD) for complete and understandable information at a glance
- Distinctive audible/vibrating alarms for dangerous gas conditions and audible alarms for unit malfunction
- Microprocessor control for reliability, ease of use, and advanced capabilities
- Alarm trend data (when used in Normal Mode)
- Data logging functions (when used in Normal Mode)
- STEL/TWA (when used in Normal Mode) and over range alarm display

- Peak hold and average readouts (when used in Normal Mode)
- Built-in time function
- RF shielded high impact plastic case
- ATEX certification for II1G Ex ia IIC T4 Ga

WARNING: The Gas Tracer detects oxygen deficiency, elevated levels of oxygen, combustible gases, and carbon monoxide, all of which can be dangerous or life threatening. When using the Gas Tracer, you must follow the instructions and warnings in this manual to assure proper and safe operation of the unit and to minimize the risk of personal injury. Be sure to maintain and periodically calibrate the Gas Tracer as described in this manual.

Specifications

Table 1: Gas Tracer Specifications

Target Gas	<ul style="list-style-type: none"> • %LEL Combustible Gas (Methane Calibration Standard)* • PPM Combustible Gas (Methane Calibration Standard)* 	% Volume Combustible Gas (Methane Calibration Standard)	Oxygen (O ₂)	Carbon Monoxide (CO)
Range (Increment)	0-100% LEL (1% LEL)	0 - 100% vol (1% vol)	0-40.0% vol (0.1 vol%)	0-500 ppm (1 ppm)
Leak Check Mode Range (Increment)	0-5000 ppm (10 ppm) <i>NOTE: Detection range is 0-5000 ppm, but displayed range can be 0-500, 0-1000, 0-2000 or 0-5000 ppm.</i>	n/a	n/a	n/a
Sampling Method	Sample Draw			
Response Time	T90 Within 30 Seconds			
Accuracy	LEL: ± 5% of reading or ± 2% LEL (whichever is greater) PPM: ± 30 ppm or ± 5% of reading (whichever is greater)	± 5% of reading or ± 2% full scale (whichever is greater)	± 0.5% O ₂	± 5% of reading or ± 5 ppm CO (whichever is greater)
Display	Digital LCD Display			
Gas Alarms (Factory Settings)	Alarm 1 10% LEL Alarm 2 50% LEL	None	Alarm 1 19.5 vol% (Decreasing) Alarm 2 23.5 vol% (Increasing)	Alarm 1 25 ppm Alarm 2 50 ppm TWA 25 ppm STEL 200 ppm
Operating Temperature & Humidity	-20°C to 50°C/Below 85% RH (Without Condensation)			

Safety/ Regulatory	<ul style="list-style-type: none"> • ATEX: II 1 G Ex ia IIC T4 Ga Certificate Number DEKRA 11ATEX0123 • IECEx: Ex ia IIC T4 Ga Certificate Number DEK 11.0045
Power Supply	<ul style="list-style-type: none"> • Three AA size alkaline batteries standard • Lithium Ion Battery Pack (3.7 VDC Nominal) optional, Direct Charging
Continuous Operating Hours @ 25 °C	<ul style="list-style-type: none"> • Alkaline Batteries: 15 Hours (Non Alarm Operation, Fully Charged) • Lithium Ion Battery Pack: 10 Hours (Non alarm Operation, Fully Charged)
Case	High-impact Plastic with protective rubber layer, RF Shielded, Dust and Weather Proof
Standard Accessories	<ul style="list-style-type: none"> • 10 foot hose • 10 inch probe • Flexible 4 inch tapered rubber nozzle
Optional Accessories	<ul style="list-style-type: none"> • Rechargeable Lithium-Ion Battery Pack • 115 VAC Charging Station • 12 VDC Charging Station • Product CD, includes Data Logger Management Program Software • IrDA/USB Cable for Downloading Data to a Computer With Data Logger Management Program (not needed if computer has an infrared port) • SDM-2012 Automatic Calibration Station & Software • Various Probes (see "Parts List" on page 186)
Dimensions and Weight	Approximately 171(H) x 65(W) x 39(D) mm (5.6"H x 2.5"W x 1.5"D) Approximately 310 g (11 oz.)
*Some versions of the Gas Tracer are available with the LEL and/or PPM sensors factory set for HC (general hydrocarbons) and calibrated to isobutane. Consult RKI Instruments, Inc. for further information.	

About this Manual

The *Gas Tracer Operator's Manual* uses the following conventions for notes, cautions, and warnings.

NOTE: Describes additional or critical information.

CAUTION: Describes potential damage to equipment.

WARNING: Describes potential danger that can result in injury or death.

Chapter 2: Description

Overview

This chapter describes the Gas Tracer instrument and accessories.

Instrument Description

The instrument includes the case, sensors, LCD, control buttons, printed circuit boards, alarm LED's, infrared communication port, buzzer, vibrator, batteries, pump, flow chamber, and inlet filter holder.

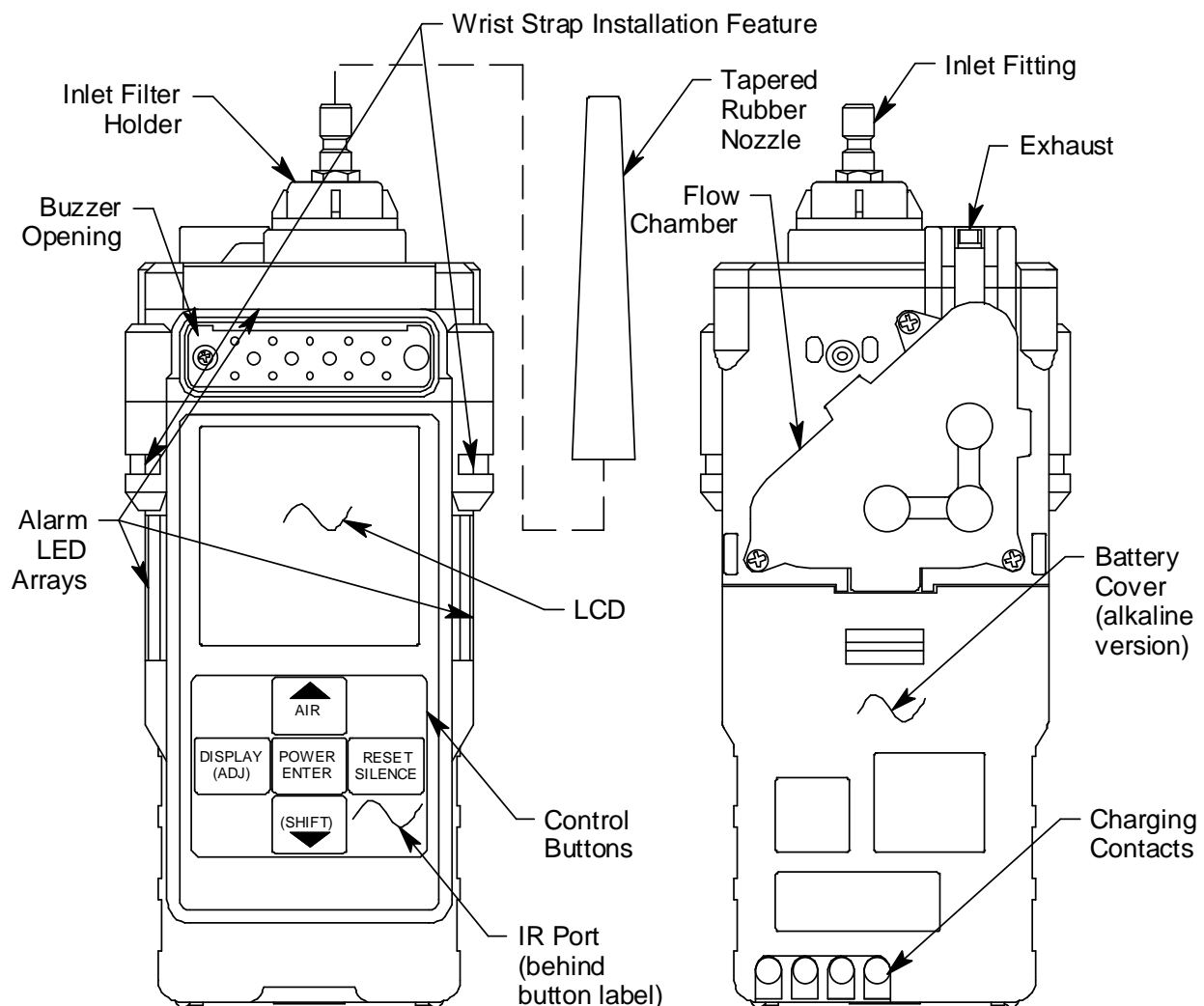

Figure 1: Components of the Gas Tracer, Front & Back

Rechargeable Version

Alkaline Version

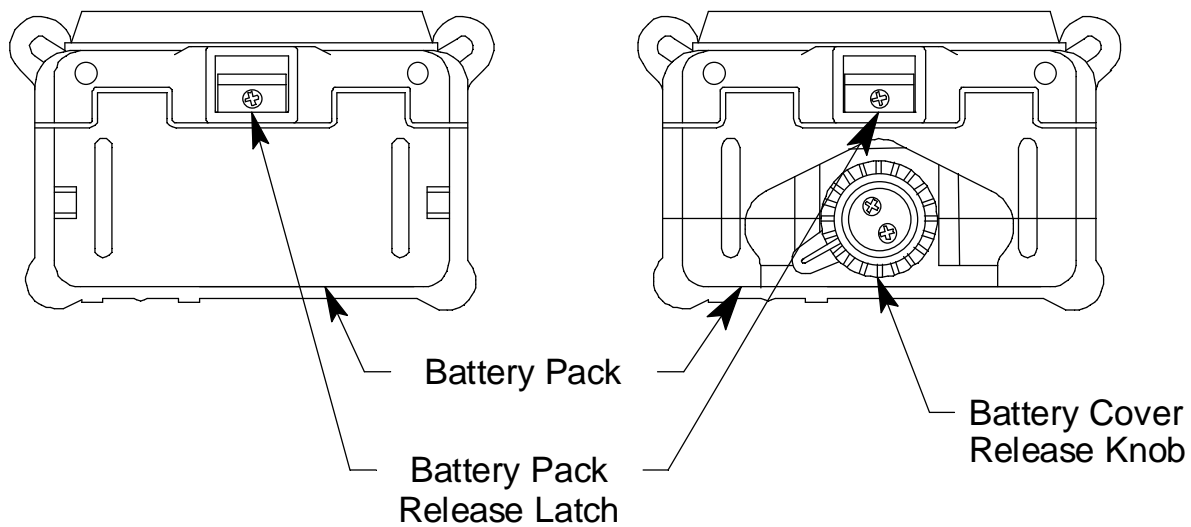

Figure 2: Components of the Gas Tracer, Bottom

Case

The Gas Tracer's sturdy, high-impact plastic case is radio frequency (RF) resistant and is suitable for use in many environmental conditions, indoors and out. The case is dust proof and weather resistant. A rubber layer on the outside of the case protects it from scratches and impact damage.

A clear plastic window through which the LCD can be viewed is located on the front of the case. Four brass charging contacts that are used when the Gas Tracer is placed in the charging station are on the back of the case. Both the rechargeable and alkaline version include a removable battery pack. The battery pack release latch is on the bottom. The alkaline battery version also includes a battery cover release knob. The battery pack and flow chamber are located on the back of the Gas Tracer. The inlet filter holder is located on the top of the Gas Tracer case.

Sensors

The Gas Tracer uses up to five sensors to monitor combustible gas, oxygen (O₂), and carbon monoxide (CO) simultaneously. The sensors are located inside the Gas Tracer and are held in their sockets by the flow chamber. The sensors use different detection principles, as described below.

Combustible Gas Sensors

% LEL Sensor (NC-6264A)

The % LEL sensor detects combustible gas in the % LEL range. It uses a catalytic element for detection. The reaction of gas with oxygen on the catalyst causes a change in the resistance of the element which affects the current flowing through it. The current is amplified by the Gas Tracer's circuitry, converted to a measurement of combustible gas concentration, and displayed on the LCD.

PPM Sensor (SH-8641)

The ppm combustible sensor detects combustible gas in the ppm range. It is used in Leak Check Mode. It is a combination catalytic/MOS type sensor with a current output. The current is amplified by the Gas Tracer's circuitry, converted to a measurement of combustible gas concentration, and displayed on the LCD.

%Volume Sensor (TE-7561)

The % volume sensor detects combustible gas in the % volume range. It uses a thermal conductivity (TC) element for detection. The presence of combustible gas cools the element causing a change in the resistance of the element which affects the current flowing through it. The current is amplified by the Gas Tracer's circuitry, converted to a measurement of combustible gas concentration, and displayed on the LCD.

Oxygen Sensor

The O₂ sensor is a galvanic type of sensor. A membrane covers the cell and allows gas to diffuse into the cell at a rate proportional to the partial pressure of oxygen. The oxygen reacts in the cell and produces a voltage proportional to the concentration of oxygen. The voltage is measured by the Gas Tracer's circuitry, converted to a measurement of gas concentration, and displayed on the LCD.

CO Sensor

The CO sensor is an electrochemical cell that consist of two precious metal electrodes in a dilute acid electrolyte. A gas permeable membrane covers the sensor face and allows gas to diffuse into the electrolyte. The gas reacts in the sensor and produces a current proportional to the concentration of the target gas. The current is amplified by the Gas Tracer's circuitry, converted to a measurement of gas concentration, and displayed on the LCD.

Dummy Sensors

Any unit that has less than 5 sensors will have a dummy sensor installed in one or more sensor positions. Dummy sensors are factory installed. The flat top of the dummy sensor should face up and the bottom hollow side should face down. The unit shown below is a standard 4-sensor unit for LEL/O₂/ppm/CO and has a dummy sensor installed in the %volume combustible sensor position.

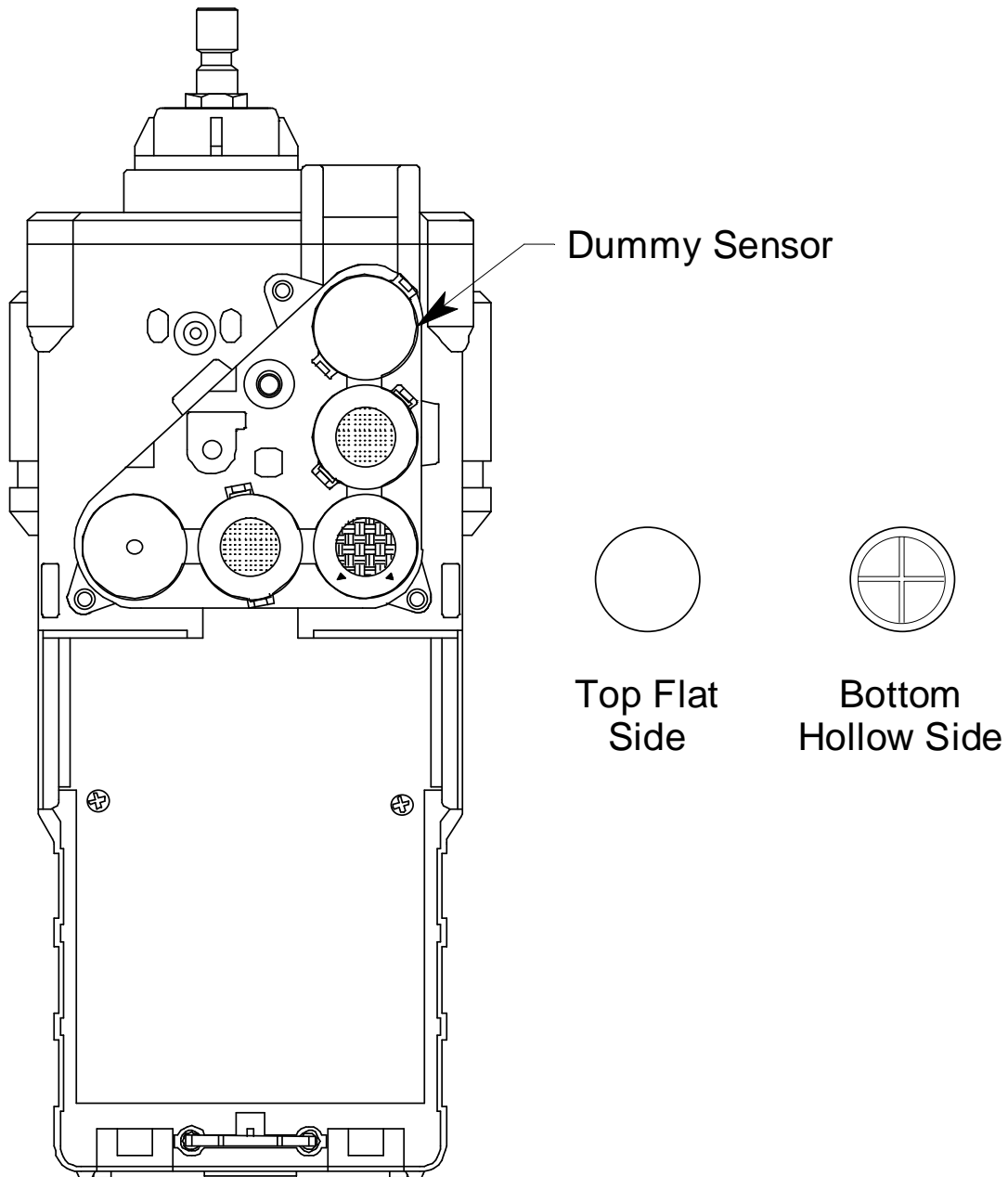

Figure 3: Dummy Sensors

LCD

A digital LCD (liquid crystal display) is visible through a clear plastic window on the front of the case. The LCD display simultaneously shows the gas reading for all installed sensors. The display also shows information for each of the Gas Tracer's program modes.

Control Buttons

Five control buttons are located below the LCD. They are arranged around a central button, the POWER ENTER button. The DISPLAY (ADJ) button is on the left, the RESET SILENCE button on the right, the AIR▲ button on the top, and the (SHIFT)▼ is on the bottom.

Table 2: Gas Tracer Control Button Functions

Button	Function(s)
POWER ENTER	<ul style="list-style-type: none">• turns the Gas Tracer on and off.• used during setup and calibration.
RESET SILENCE	silences and resets audible alarm if the Gas Tracer is programmed for latching alarms and the alarm silence option is on ¹
DISPLAY (ADJ)	<ul style="list-style-type: none">• activates Display Mode• enters instructions into the Gas Tracer's microprocessor
AIR▲	<ul style="list-style-type: none">• activates the demand-zero function (automatically adjusts the Gas Tracer in fresh-air conditions)• scrolls through the display and settings modes
(SHIFT)▼	<ul style="list-style-type: none">• scrolls through the display and settings modes• enters instructions into the Gas Tracer's microprocessor
¹ The Gas Tracer's alarms are user-adjustable. See "Chapter 6: Maintenance Mode" on page 115.	

Printed Circuit Boards

The Gas Tracer printed circuit boards analyze, record, control, store, and display the information collected. The circuit boards are located inside the case. They are not user serviceable.

Alarm LED Arrays

Three red alarm LED (light emitting diode) arrays are visible through frosted plastic lenses in the case. One is on the top front, one on the left side, and one on the right side. The alarm LED arrays alert you to gas, low battery, and failure alarms.

Infrared Communications Port

An infrared (IR) communications port is located just below the RESET SILENCE button. The signal goes through the control button material.

The data transmitted through the port is in standard IrDA protocol. A computer's infrared port or an IrDA/USB cable connected to a computer's USB port can be used to download data saved by the Gas Tracer to a computer using the Gas Tracer Data Logger Management Program. See the GX-2012 Data Logger Management Program operator's manual for data logging and downloading instructions.

Buzzer

One solid-state electronic buzzer is located inside the case. Holes on the top front of the case allow the sound to exit the case. The buzzer sounds for gas alarms, malfunctions, low battery voltage, and as an indicator during use of the Gas Tracer's many display and adjustment options.

Vibrator

A vibrating motor inside the Gas Tracer case vibrates for gas alarms, unit malfunctions, and as an indicator during normal use of the various modes of the Gas Tracer.

Batteries

Three AA-size alkaline batteries (standard) or an optional rechargeable lithium ion battery pack (3.7 VDC) power the Gas Tracer. Instrument run time is dependent upon battery type. At 25°C the alkaline batteries last up to 15 hours and the lithium ion battery pack lasts up to 10 hours. The battery icon in the upper right of the LCD shows remaining battery life.

When the Gas Tracer detects a low battery voltage, a low battery warning is activated. When battery voltage is too low for normal operation, the Gas Tracer sounds a dead battery alarm.

The alkaline batteries can be replaced by removing the battery cover on the back of the case. The lithium ion pack can be replaced by removing the entire battery pack. Push the battery pack latch on the bottom of the unit toward the front of the unit to release the pack.

The lithium ion battery pack can be recharged by placing the Gas Tracer in its optional battery charging station or by placing the battery pack in the charging station.

NOTE: Use of batteries or battery chargers not specified by RKI Instruments, Inc. will void the CSA classification and may void the warranty. See "Replacing or Recharging the Batteries" on page 173.

WARNING: To prevent ignition of a hazardous atmosphere, batteries must only be changed or charged in an area known to be nonhazardous.

Pump

A diaphragm pump inside the Gas Tracer draws the sample to the sensors. It can draw sample from as far as 50 feet from the Gas Tracer. The pump is not user serviceable.

CAUTION: Sample hose lengths of more than 50 feet are not recommended for the Gas Tracer because of flow rate reduction.

Flow Chamber

The flow chamber is on the back of the Gas Tracer and is held in place by three phillips screws. The flow chamber seals to the rubber sensor gasket which seals to the sensor faces inside the Gas Tracer and routes flow from the pump to the sensors to the exhaust port (also a part of the flow chamber).

Sensors and Filters

The sensors are located underneath the flow chamber and are only accessible if you remove the flow chamber and the sensor gasket.

An H₂S removal filter disk is placed into a recess in the sensor gasket over the %LEL sensor. It prevents H₂S in the ambient air from reaching the unit's combustible gas sensor. Removing H₂S that is present in the monitored air prolongs the life of the sensor. The H₂S filter disk is dark red in color and although it may darken over time, its color is not indicative of remaining filter life. The H₂S filter disk can absorb H₂S for 33 ppm hours and should be replaced after that much exposure. With this many ppm hours of absorption, the H₂S filter disk should be replaced after 80 minutes of exposure to 25 ppm H₂S. This equates to replacing the H₂S filter disk after 40 2-minute calibrations with a cylinder containing 25 ppm H₂S. If H₂S exists in the monitoring environment, the H₂S filter disk will have to be replaced more frequently.

A charcoal filter is placed into a recess in the sensor gasket over the CO sensor. The charcoal filter is black, has a woven texture, and is impregnated with an H₂S absorbing material. The CO sensor will respond if exposed to H₂S and certain hydrocarbon gases. The charcoal filter disk scrubs these gases out of the sample to avoid false CO readings. If false or elevated CO readings are noticed, especially in

the presence of H₂S, change the charcoal filter.

NOTE: If you have a Gas Tracer that is intended for CO with H₂S response operation, a charcoal filter will not be installed. Do not install a charcoal filter.

Inlet Filter Holder

The filter holder is a clear plastic dome shaped piece on the top of the case. A male quick connect fitting is located on the inlet filter holder. This is the Gas Tracer's inlet fitting. A cotton dust filter is inside the filter holder. The filter holder may be removed by turning it counterclockwise and pulling it away from the case. Two flat membrane disk hydrophobic filters, a wire mesh disk, and a rubber filter retaining gasket are held in place by the filter holder and are located in the bottom of the case chamber where the filter holder is installed.

Standard Accessories

The standard accessories include the tapered rubber nozzle, belt clip, sample hose, and 10 inch probe. An optional bar hole probe is also available and is described at the end of this section.

Tapered Rubber Nozzle

A cone shaped 4 inch long rubber nozzle is included with the Gas Tracer as standard. It can be installed on the inlet fitting by pushing the larger end over it. The smaller end can be inserted through a hole in a wall or some other access to an enclosed area to sample the environment.

Belt Clip

A belt clip can be mounted to the back of the case using 3 phillips head screws. The belt clip allows the Gas Tracer to be securely attached to a belt.

Wrist Strap

A wrist strap is included with the Gas Tracer and can be attached to the right or left wrist strap installation feature.

Sample Hose & 10 Inch Probe

A 10 foot sample hose and a 10 inch probe are included as standard with the Gas Tracer. When desired, the rubber nozzle may be removed and the sample hose and 10 inch probe may be connected to the inlet

fitting. Sample hose lengths are available from 10 feet to 50 feet (see “Parts List” on page 186). The quick connect end of the sample hose connects to the inlet fitting of the Gas Tracer and the probe screws onto the end of the hose with the threaded fitting.

CAUTION: *Sample hose lengths of more than 50 feet are not recommended for the Gas Tracer because of flow rate reduction.*

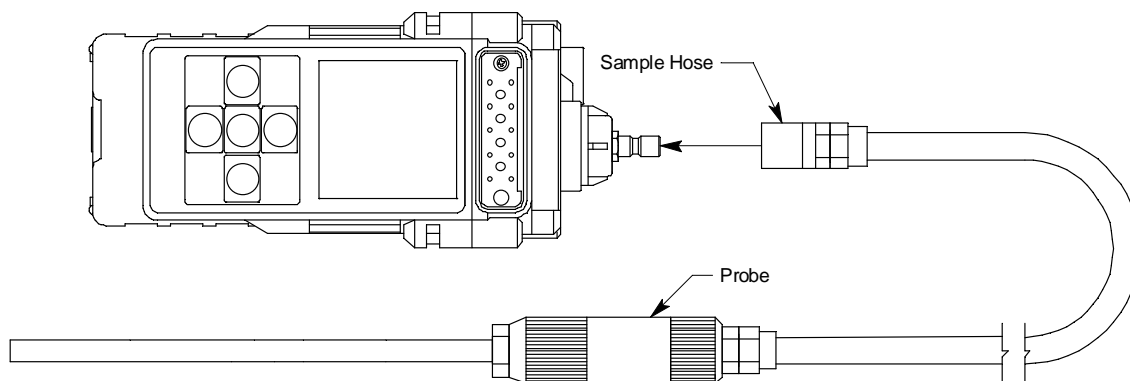

Figure 4: Sample Hose and Probe

Optional Accessories

Several optional accessories are available for the Gas Tracer. They include a rechargeable lithium ion battery pack, battery charging stations, various special probes, a purge tee fitting, and a dilution fitting. The most commonly used optional accessories are described below. Detailed instructions regarding the use of these and other available accessories are included in other parts of this manual. Data logging accessories are briefly described in “Data Logging” on page 60.

Rechargeable Lithium Ion Battery Pack

A rechargeable lithium ion battery pack is available for the Gas Tracer. A fully charged battery pack will power the Gas Tracer for 10 hours. The batteries will last for a minimum of 500 charge cycles. See the “Parts List” on page 186 for ordering information.

Charging Stations

The Gas Tracer lithium ion battery pack is charged with the Gas Tracer charging station. Two battery charging stations are available for the Gas Tracer, the standard AC charging station, and a DC charging station with a vehicle plug adapter.

AC Powered Charging Station

The standard AC powered charging station consists of an instrument charging base and an AC adapter. The AC adapter plugs into a 115 VAC wall outlet and connects to the charging station with a jack on the end of a five foot DC output cable. The AC adapter will also work for 100 VAC or 220 VAC if an appropriate plug adapter is provided. The AC charging station is shown below in Figure 5.

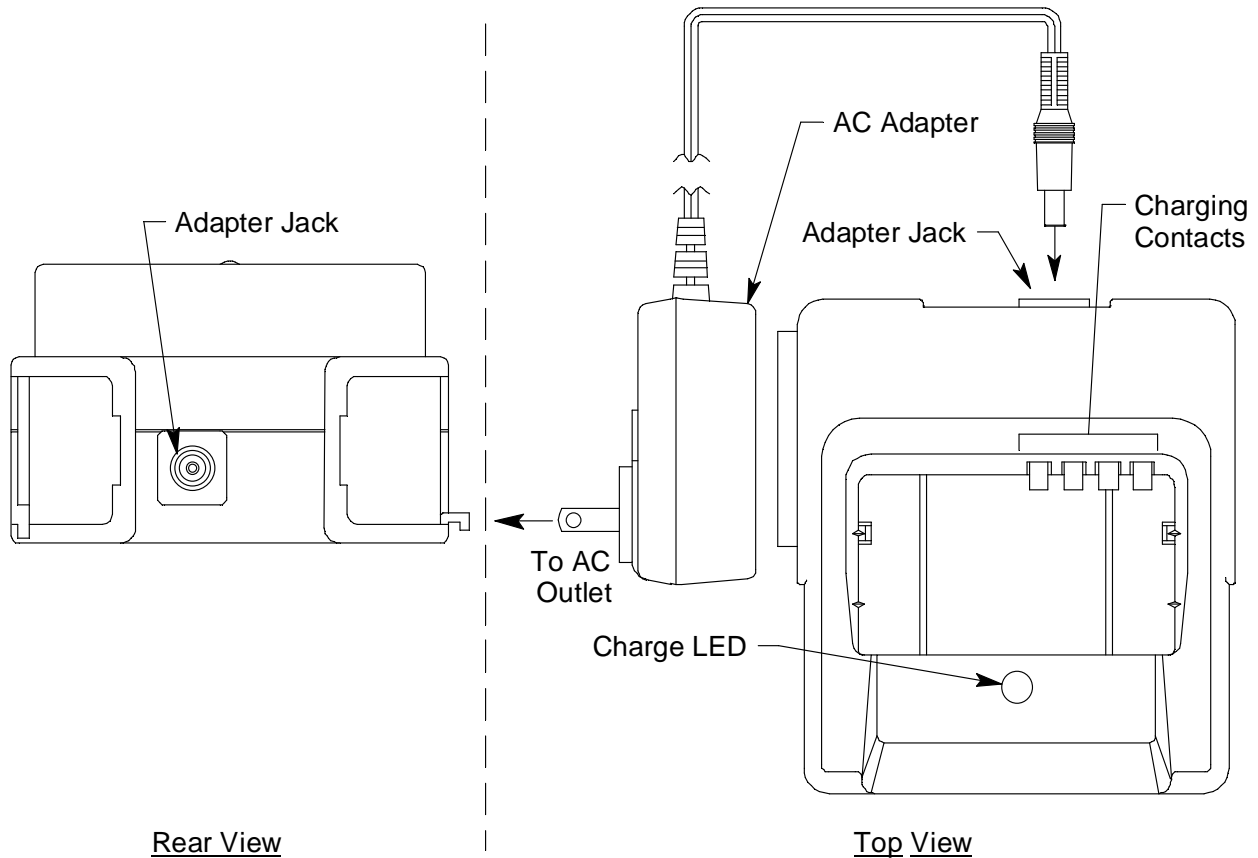

Figure 5: Gas Tracer AC Powered Charging Station

DC Powered Charging Station

An optional DC powered charging station is available with a vehicle plug 12 VDC adapter. It uses the same charging base as the AC charging station but comes with a velcro strap to secure the Gas Tracer in the charging base.

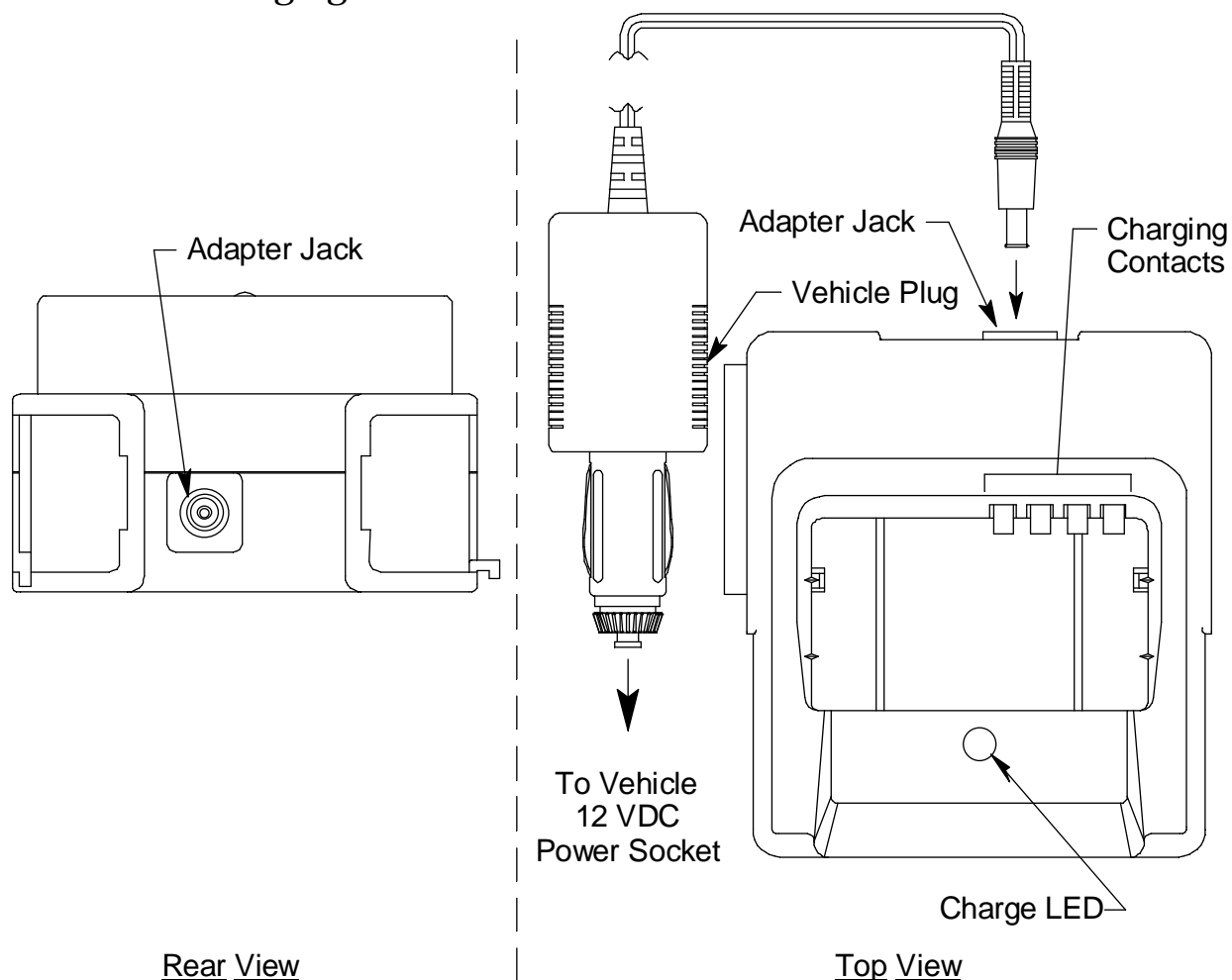

Figure 6: Gas Tracer DC Powered Charging Station

Optional Probes

Various optional probes designed for specific applications are available for the Gas Tracer. They include the following:

- 30 inch aluminum probe

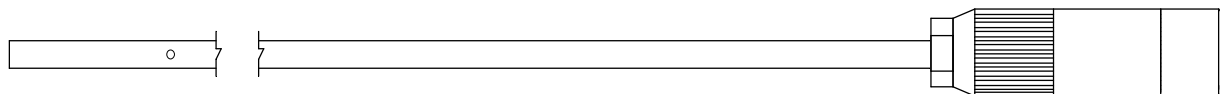

Figure 7: 30 Inch Aluminum Probe

This probe is designed for applications where it is necessary to put the probe tip in areas that are out of reach with the standard probe. A small breather hole near the end of the probe tube prevents

interruption of sampling and a low flow alarm if the probe tip is blocked.

- 30 inch stainless steel probe

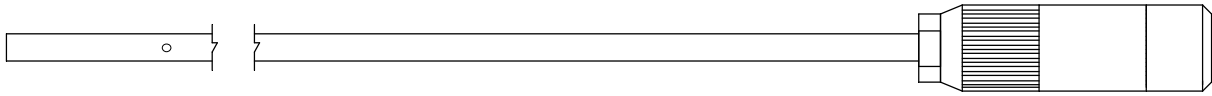

Figure 8: 30 Inch Stainless Steel Probe

This probe is physically the same as the 30 inch aluminum probe and is intended for applications where a high level of corrosion resistance is required in the long probe tube.

- Barhole probe

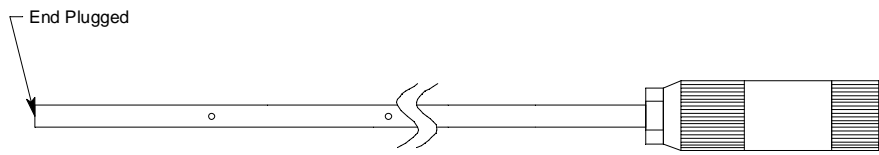

Figure 9: Barhole Probe

An optional bar hole probe is available for the Gas Tracer. It is designed to be used when the Gas Tracer is operated in Bar Hole Mode to check bar holes when tracking down underground gas pipe leaks (see “Chapter 4: Using the Gas Tracer in Bar Hole Mode” on page 88). The bar hole probe has the same handle as the standard probe, but has a 30 inch fiberglass tube instead of the standard tube. Four holes are drilled through the 30 inch tube’s wall near the end and the end is plugged so that debris from the barhole cannot be drawn into the tube. The sample is drawn through the drilled holes in the tube wall.

- 32 inch telescoping probe with dust filter

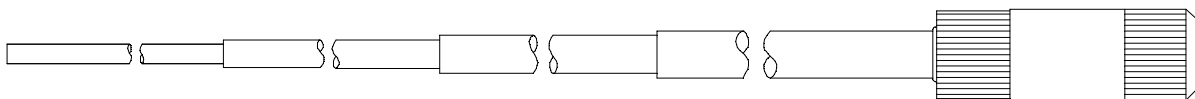

Figure 10: 32 Inch Telescoping Probe with Dust Filter

This probe is designed for use where it is necessary to put the probe tip in areas not accessible with the 10 inch probe with dust filter and applications where the probe tube must be collapsible for storage.

- 7 foot telescoping probe with dust filter

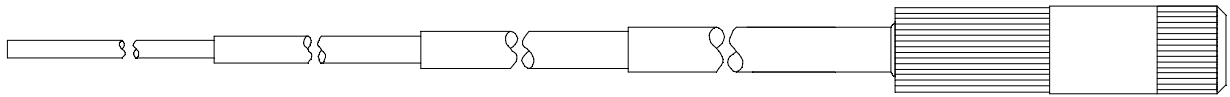

Figure 11: 7 Foot Telescoping Probe with Dust Filter

This probe is designed for use where it is necessary to put the probe tip in areas not accessible with the 32 inch telescoping probe with dust filter and applications where the probe tube must be collapsible for storage.

- 8 meter hose with floating head

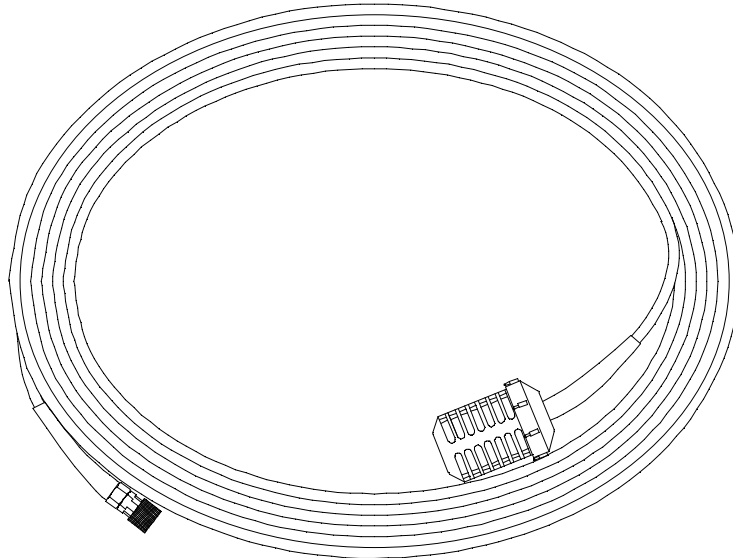

Figure 12: 8 Meter Hose with Floating Head

This probe is designed to be used in a tank or a well that may have water or some other liquid at the bottom. As you lower the probe down, if it hits water, it will float and continue to monitor the area.

See the “Parts List” on page 186 for probe ordering information.

Purge Tee Fitting

The 17-4430RK-01 purge fitting is used to detect gas levels in a pressurized gas stream from a pipeline or vessel being purged. The sample port of the purge fitting is inserted into the flowing gas, and the vent port will allow any excess gas to release to the atmosphere to avoid damage to pump or sensors.

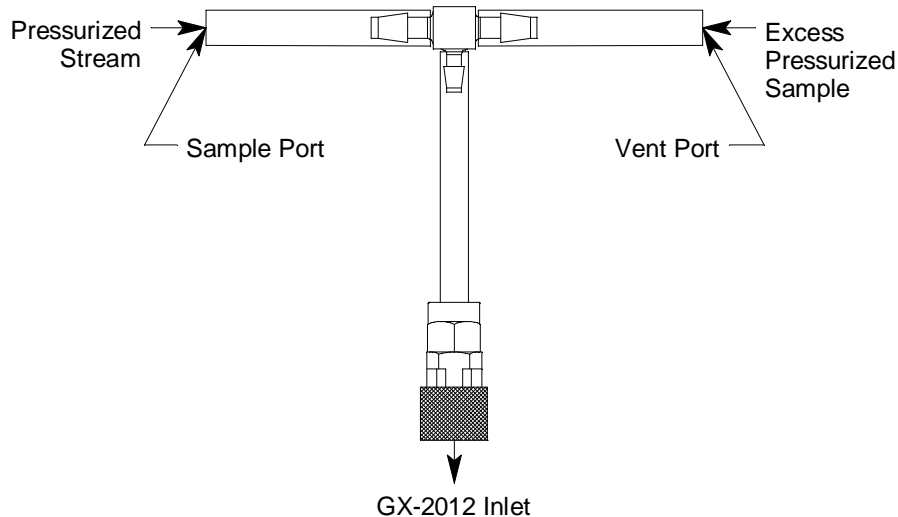

Figure 13: Purge Tee Fitting

External Dilution Fitting

An external dilution fitting is available for the Gas Tracer. It is a 1:1 dilution fitting and is designed to mate with the inlet fitting and accept a sample hose or probe. The fittings are made with brass and nickel plated brass and are appropriate for use with the four standard gases. The dilution fitting is normally used when it is necessary to introduce air into a sample that has no oxygen or a very low level of oxygen, such as a nitrogen purged sample. It can also be used when one of the target gas levels in the sample area will likely be present in a concentration above the detection range for that gas. Since the fittings partially consist of unplated brass, they are not appropriate for detection of elevated levels of H₂S.

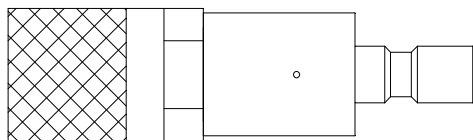

Figure 14: Dilution Fitting

Humidifier Tube

A 6 inch humidifier tube comes with any calibration kits purchased for the Gas Tracer. It is for use in calibrating the ppm combustible gas sensor. If you did not purchase a calibration kit for the Gas Tracer and purchased calibration cylinders independently, you will need to

purchase a humidifier tube in order to properly calibrate the ppm combustible gas sensor. Use the humidifier tube to connect the ppm calibration cylinder to the Gas Tracer.

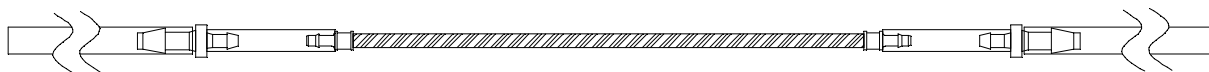

Figure 15: Humidifier Tube

NOTE: When removing the humidifier tube from the Gas Tracer or a demand flow regulator, be sure to grasp it by the clear tubing at the ends of the humidifier tube assembly, not the humidifier tube itself.

Chapter 3: Using the Gas Tracer in Normal Mode

Overview

This chapter explains how to operate the Gas Tracer in Normal Mode. Normal Mode is used to perform confined space entry monitoring or general area monitoring. While in Normal Mode, Display Mode and Calibration Mode are accessible.

Start Up, Normal Mode

This section explains how to start up the Gas Tracer in Normal Mode, get it ready for operation, and turn it off.

NOTE: The screens illustrated in this section are for a 3-gas unit that has the % LEL range for the combustible gas channel. The screens displayed by your Gas Tracer may be slightly different.

Turning On the Gas Tracer, Normal Mode Only

The following description of the Gas Tracer start up sequence assumes that the following items in Maintenance Mode are turned on: **LNCH BRK**, **ID DISP**, **CL RMNDR**, and **BP RMNDR**. If any of these items is turned off, then the corresponding screen will not appear. This description also assumes that Bar Hole Mode and Leak Check Mode are not active.

1. Connect the tapered rubber nozzle or the sample hose to the Gas Tracer's quick connect inlet fitting.
2. If a sample hose is used, screw the probe onto the sample hose's threaded fitting.
3. Press and briefly hold down the POWER ENTER button. Release the button when you hear a beep.

4. If **LNCH BRK** is turned on, the Resume Datalog Screen displays.

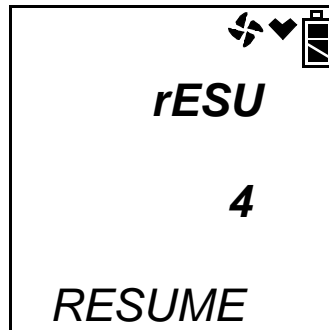

- Press and release the POWER ENTER button to continue accumulating time-weighted average (TWA), PEAK readings, and time in operation from the last time the Gas Tracer was used. The short-term exposure limit [STEL] reading is reset each time the Gas Tracer is turned on.
- Press and release the DISPLAY(ADJ) button to reset the accumulation of these measurements.

If you do not press the POWER ENTER or DISPLAY(ADJ) button within 5 seconds, the Gas Tracer automatically resumes accumulating the TWA, PEAK readings, and time in operation.

5. If **CL RMNDR** is turned on (factory setting), the screen that appears next depends on how **CL EXPRD** is set in the Maintenance Mode Menu (page 156).
- If the unit is due for calibration and **CL EXPRD** is set to CONFIRM (factory setting), then the following screen displays.

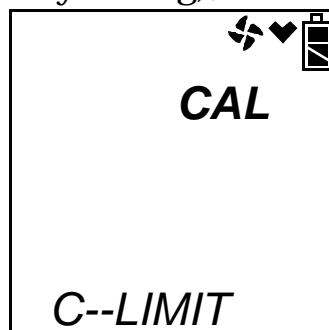

The alarm LED's and buzzer will pulse several times. After this, press the RESET SILENCE button until you hear a beep to continue.

- If the unit is due for calibration and **CL EXPRD** is set to NOT USE, then the following screen displays.

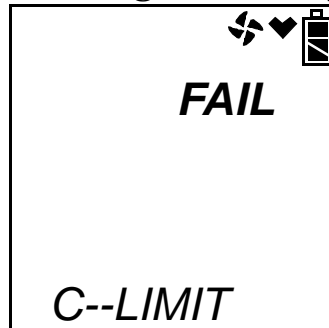

The Gas Tracer cannot be used until a calibration has been performed either by selecting **AUTO CAL** or **ONE CAL** in the Maintenance Mode menu. See “Calibrating Using Auto Calibration” on page 120 or “Calibrating Using Single Calibration” on page 123 for calibration instructions.

- If calibration is not due or **CL EXPRD** is set to NO EFFECT, then the following screen appears for a few seconds indicating when the next calibration is due.

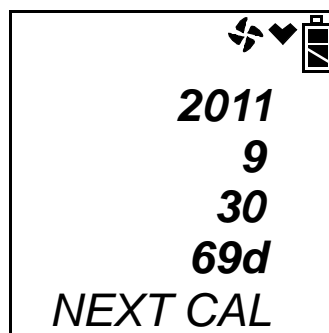

6. If **BP RMNDR** is turned on (factory setting is OFF), the screen that appears next depends on how **BP EXPRD** is set in the Maintenance Mode Menu (page 156).

- If the unit is due for a bump test and **BP EXPRD** is set to CONFIRM (factory setting), then the following screen displays.

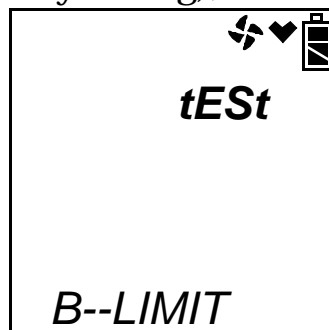

The alarm LED's and buzzer will pulse several times. After this, press the RESET SILENCE button until you hear a beep to

continue.

- If the unit is due for a bump test and **BP EXPRD** is set to NOT USE, then the following screen displays.

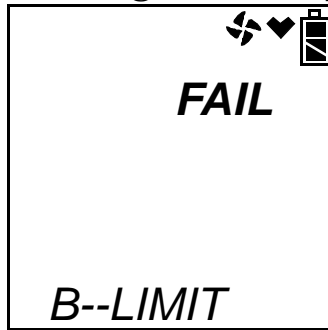

The Gas Tracer cannot be used until a bump test has been performed by selecting **BUMP** in the Maintenance Mode menu. See “Performing a Bump Test” on page 126 for bump testing instructions.

- If a bump test is not due or **BP EXPRD** is set to NO EFFECT, then the following screen appears for a few seconds indicating when the next bump test is due.

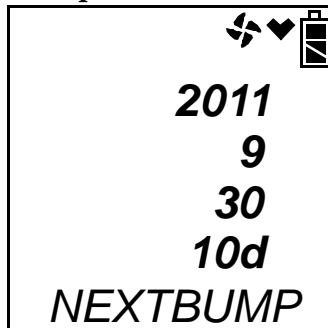

NOTE: If both **CL RMNDR** and **BP RMNDR** are turned off, a WARM UP screen will display before the warm up sequence continues.

7. If **ID DISP** is turned on (see page 161), the User ID Screen displays for a few seconds and then the Station ID Screen displays for a few seconds.

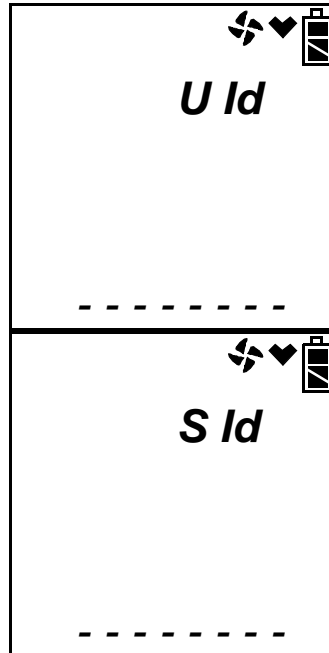

8. The Date/Time Screen appears for a few seconds.

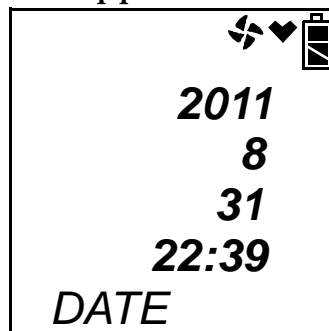

This screen displays the current year, month, day, and time.

9. The Battery Level and Alarm Pattern Screen appears next.

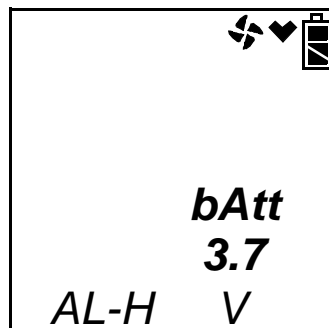

AL -- H indicates latching (hold) alarms and AL -- A indicates self-resetting (automatic) alarms. The number shown indicates the voltage of the batteries. A fully charged lithium ion battery pack will display 3.7 V. If the unit is powered by alkaline (dry cell)

batteries, a “D” will appear in front of the “V” in the lower right corner.

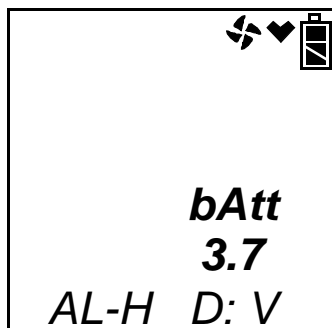

10. The display then indicates the following items for about a second each:

- Full scale values for all channels
- Warning setpoint (low gas alarm) for all channels
- Alarm setpoint (high gas alarm) for all channels
- STEL alarm setpoint for the CO channel
- TWA alarm setpoint for the CO channel

NOTE: If the combustible channel is factory set as %volume only, all gas alarms are turned off. You must press and release the RESET SILENCE button at the warning, alarm, STEL, and TWA screens to acknowledge that there are no gas alarms. The warm up will not proceed until you do so.

If the combustible channel is set as %volume only using the HC Range Screen in Display Mode, it will automatically revert to Autoranging when it is turned off and on again and the no alarm acknowledgement screen will not appear.

11. If the Gas Tracer experiences a sensor failure during start up, a screen indicating which sensor failed displays. In the example below, the CO sensor has failed.

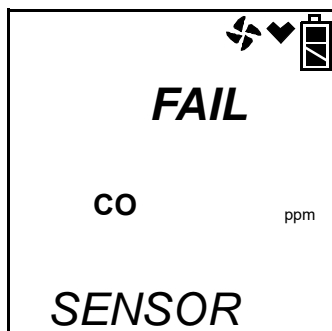

If you wish to continue, press and release the RESET SILENCE button to acknowledge the failure. The gas reading for the failed sensor will be replaced by “---”. Replace the failed sensor as soon as possible.

12. The Gas Tracer is now operating in Normal Mode and monitoring for gas in Measuring Mode. The Normal Operation Screen appears.

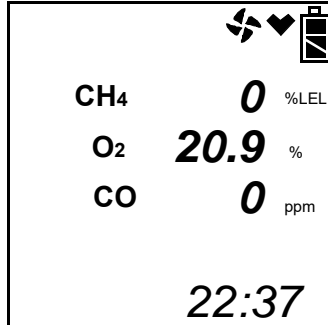

The concentrations of the target gases are displayed along with the time and battery charge level. The heart symbol displayed just to the left of the battery charge level flashes while the instrument is functioning properly. If it disappears or is steadily on, the unit is experiencing a microprocessor error. The fan symbol just to the left of the heart symbol spins while the pump is operating.

Turning On the Gas Tracer in Normal Mode With All Modes Active

If the **L./B. MODE** item in Maintenance Mode is set to LC, bH, or LC bH (see “Updating the Leak Check/Bar Hole Mode Setting” on page 163), then the user must select Normal Mode during the start up sequence to operate in Normal Mode. The standard factory setting is LC. See “Chapter 4: Using the Gas Tracer in Bar Hole Mode” on page 88 for a description of Bar Hole Mode or “Chapter 5: Using the Gas Tracer in Leak Check Mode” on page 98 for a description of Leak Check Mode.

The following description of the Gas Tracer start up sequence assumes that the following menu items in Maintenance Mode are turned on: **LNCH BRK**, **ID DISP**, **CL RMNDR**, and **BP RMNDR**. If any of these items is turned off, then the corresponding screen will not appear. It also assumes that **L./B. MODE** is set to LC bH. If **L./B. MODE** is set to LC, the Bar Hole Mode Select Screen will not appear. If **L./B. MODE** is set to bH, the Leak Check Mode Select Screen will not appear.

1. Connect the tapered rubber nozzle or the sample hose to the Gas Tracer’s quick connect inlet fitting.
2. If a sample hose is used, screw the probe onto the sample hose’s

threaded fitting.

3. Press and briefly hold down the POWER ENTER button. The Normal Mode Select Screen displays.

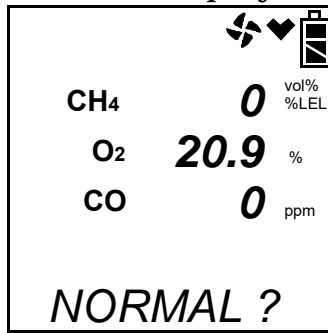

4. You can use the AIR▲ button to scroll to the Bar Hole Mode Select Screen.

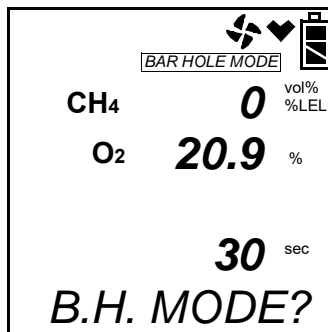

5. Press the AIR▲ button again to display the Leak Check Mode Select Screen.

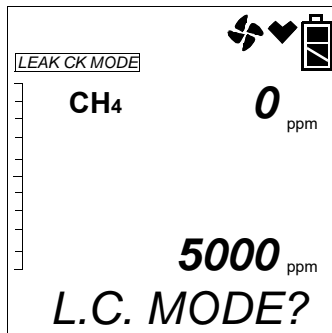

CO DISP OFF

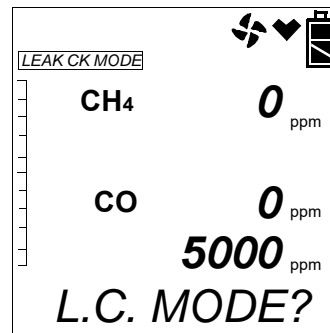

CO DISP On

NOTE: If the **CO DISP** parameter in Maintenance Mode is set to **On**, the CO channel will appear in Leak Check Mode. If the **CO DISP** parameter is set to **OFF** (factory setting), the CO channel will not appear in Leak Check Mode. See “Chapter 5: Using the Gas Tracer in Leak Check Mode” on page 98 for more information.

You can scroll up or down through these screens using the AIR▲ and (SHIFT)▼ buttons.

6. With the Normal Mode Select Screen displayed, press and release the POWER ENTER button and continue with the startup sequence as described in the previous section, “Turning On the Gas Tracer, Normal Mode Only”, from step 4 on page 21 on.

NOTE: If no button is pressed for 20 seconds, the unit will proceed into whichever mode is displayed.

7. To exit Normal Mode and return to the Mode Select Screen, press and hold the (SHIFT)▼ button for 5 seconds while in the Normal Operation Screen.

Performing a Fresh Air Adjustment, Normal Mode

Before using the Gas Tracer, it is recommended to set the fresh air readings for the target gases by performing a fresh air adjustment. This will set the combustible gas and CO channels to zero and the OXY channel to 20.9%.

1. Find a fresh-air environment. This is an environment free of toxic or combustible gases and of normal oxygen content (20.9%).
2. Turn on the unit as described above in “Turning On the Gas Tracer, Normal Mode Only” or “Turning On the Gas Tracer in Normal Mode With All Modes Active”.
3. Press and hold the AIR▲ button. The display prompts you to hold the AIR▲ button.

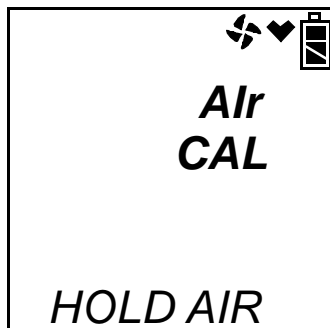

4. Continue to hold the AIR▲ button until the display prompts you to release the AIR▲ button. The Gas Tracer will count down from 8 on an autoranging combustible gas channel as it sets the fresh air reading for all channels. Once the countdown has finished, start up is complete and the unit is ready for monitoring.

Turning Off the Gas Tracer, Normal Mode

1. Press and hold the POWER ENTER button.
2. The buzzer will pulse for about three seconds and TURN OFF will be displayed along the bottom of the screen.
3. Release the button when TURN OFF disappears.

Measuring Mode, Normal Operation

The Gas Tracer has three operating modes within Normal Mode: Measuring Mode, Display Mode, and Calibration Mode. This section describes using the Gas Tracer in Measuring Mode during normal operation.

In Measuring Mode the Gas Tracer continuously monitors the sampled atmosphere and displays the gas concentrations present for its target gases. In a low-light environment, press and release any button to turn on the display backlight. See “Updating the LCD Back Light Time Setting” on page 161 to program backlight duration. If **BEEP. SET** menu item in Maintenance Mode is turned on, the Gas Tracer beeps once every 5 minutes to confirm that it’s operating. See “Updating the Confirmation Beep Setting” on page 154 for instructions to update the setting.

Monitoring an Area

1. Start up the Gas Tracer as described above in “Start Up, Normal Mode” on page 20 or “Turning On the Gas Tracer in Normal Mode With All Modes Active”. It is now in Measuring Mode.

2. Take the Gas Tracer to the monitoring area.

If the tapered rubber nozzle is used, put the nozzle tip in the area to be monitored.

If the hose and probe is used, put the probe tip in the area to be monitored.

3. Wait 10 - 15 seconds and observe the display for gas readings. If a reading is observed, allow the reading to stabilize to determine the gas concentrations present.

NOTE: Response time increases with the length of the sample hose. Long sample hoses will require more time to show a response at the Gas Tracer. The maximum sample hose length recommended for the Gas Tracer is 50 feet. Consult RKI Instruments, Inc. for longer sample hose lengths.

4. If a gas alarm occurs, take appropriate action. See “Responding to Alarms” on page 41.

Using Optional Probes and Fittings

This section describes how to use the 8 meter hose with floating head and the purge tee fitting.

Using the 8 Meter Hose with Floating Head

This probe is designed to be used in a tank or a well that may have water or some other liquid at the bottom. To use the 8 meter hose with floating probe:

1. Start up the Gas Tracer as described in “Start Up, Normal Mode” on page 20.
2. Connect the 8 meter hose with floating probe to the Gas Tracer’s quick connect inlet fitting.
3. Slowly lower the probe into the area you wish to monitor. If the probe hits water, it will float and continue to monitor the area.

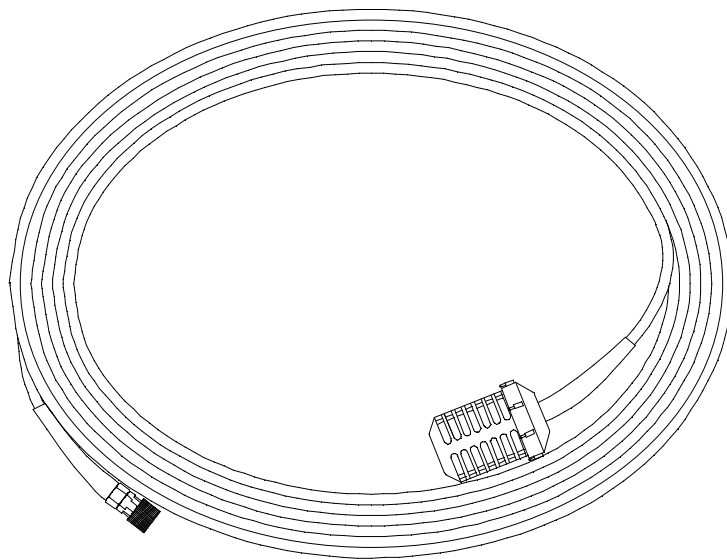

Figure 16: 8 Meter Hose with Floating Head

Using the Purge Tee Fitting

The purge fitting is used to detect gas levels in a pressurized gas stream from a pipeline or vessel being purged.

1. Start up the Gas Tracer as described in “Start Up, Normal Mode”

on page 20.

2. Connect the purge tee fitting to the Gas Tracer's quick connect inlet fitting.
3. Insert the sample port into the flowing gas. The vent port will allow any excess gas to release to the atmosphere to avoid damage to pump or sensors.

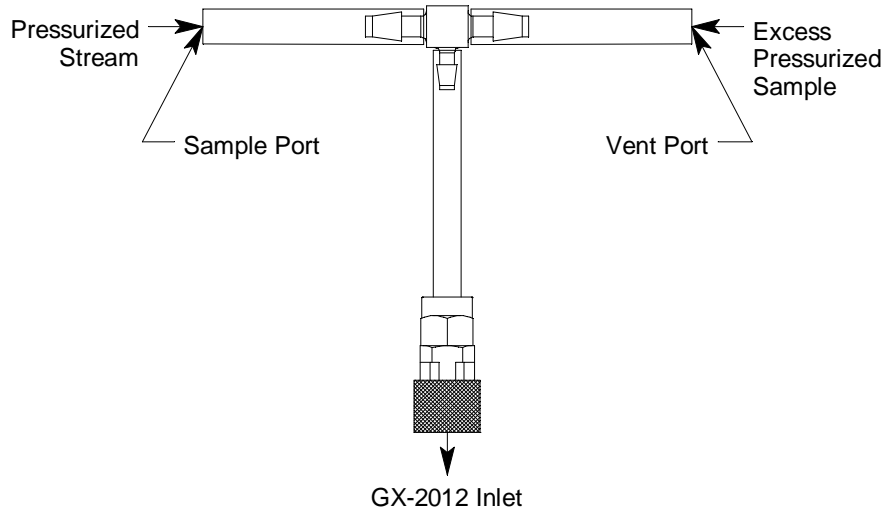

Figure 17: Purge Tee Fitting

Using the Dilution Fitting

The external dilution fitting is a 1:1 dilution fitting. It is normally used when it is necessary to introduce air into a sample that has no oxygen or a very low level of oxygen, such as a nitrogen purged sample. It can also be used when one of the target gas levels in the sample area will likely be present in a concentration above the detection range for that gas. Since the fittings partially consist of unplated brass, they are not appropriate for detection of elevated levels of H₂S.

1. Start up the Gas Tracer as described in "Start Up, Normal Mode" on page 20.
2. Install the dilution fitting to the Gas Tracer's quick connect inlet fitting.
3. Connect the tapered rubber nozzle or the sample hose to the Gas Tracer's quick connect inlet fitting.
4. If a sample hose is used, screw the probe onto the sample hose's threaded fitting.
5. Monitor the sampling area.

NOTE: The Gas Tracer can be calibrated either with or without the dilution fitting in place. If calibrated without the dilution fitting in place, then display readings must be doubled to determine the actual gas concentration. If calibrated with the dilution fitting in place, then a sample bag must be used during calibration, and the display readings will be the actual gas concentrations.

CAUTION: *If the dilution fitting is in place for calibration, do not use a demand flow regulator. Use a sample bag. The use of a demand flow regulator with a dilution fitting when calibrating will result in an inaccurate calibration.*

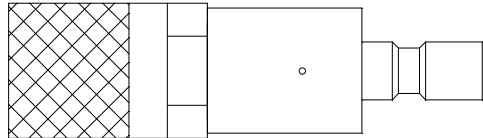

Figure 18: Dilution Fitting

Combustible Gas Detection

The Gas Tracer can support two combustible gas sensors, a TC (thermal conductivity) sensor for detection in the % volume range, and a catalytic sensor for detection in the % LEL range. Either or both sensors may be installed in your unit.

If both the % volume and % LEL sensors are installed, the combustible gas channel is setup at the factory as % LEL/% volume autoranging. In this case, the combustible gas channel will display the combustible gas concentration in % LEL up to 100% LEL. If the combustible gas concentration rises above 100% LEL, then the unit automatically begins displaying the concentration in % volume.

CAUTION: *If both combustible sensors are installed in your instrument, make sure you follow the recommendations in the next section, “Applications with High Levels of Combustible Gas” on page 33, to protect the % LEL sensor. Failure to do so will result in damage to the % LEL sensor.*

WARNING: *If the combustible channel is set for % volume only, then there are no gas alarms for any detection channel. See “HC Range Screen” on page 46.*

There are three important issues to keep in mind when monitoring for combustible gas.

Applications with High Levels of Combustible Gas

The Gas Tracer provides the % LEL sensor with some protection by turning off the % LEL sensor power temporarily when it determines that a % LEL over scale (more than 100% LEL) concentration of combustible gas is present. When this happens, “OVER” is displayed below the gas list and the display units to the right of the combustible gas channel change to % volume. However, this protection is not adequate to completely prevent damage to the sensor when it is exposed to moderate or high levels of % volume gas.

Combustible gas is present at moderate or high % volume levels in many applications such as purging applications. If your Gas Tracer is equipped with both the % LEL and %volume sensors, you must set up the instrument so that the combustible channel operates in the %volume only range when you use the instrument for this type of application to protect the % LEL sensor from damage. You can set the combustible channel to operate in the % volume range only in the HC Range Screen of Display Mode. See “HC Range Screen” on page 46 for instructions to set the combustible channel to operate in the % volume range only.

CAUTION: *Failure to set the combustible channel to % volume only operation when using the Gas Tracer for applications with moderate to high % volume levels of combustible gas will result in damage to the % LEL sensor.*

The instrument may be set up for combustible channel autoranging operation when it is used for confined space applications where % volume combustible gas concentrations are not likely to be found.

Silicone & Other Potentially Damaging Compounds

Silicone vapors and chlorine and fluorine compounds, such as chlorinated hydrocarbons, can damage the %LEL sensor. These compounds should be avoided. If exposure to these compounds is suspected, verify the %LEL response on a known gas sample.

%LEL Sensor Relative Responses

Although the standard factory setup and calibration for the combustible gas channel is to methane (CH₄), the combustible sensors will respond to other combustible gases as well.

The table below lists the conversion factors for several hydrocarbon gases **for the % LEL combustible sensor if it is calibrated to methane**. Conversion factors are not available for the % volume TC sensor. To use this table, multiply the display reading on the combustible gas channel by the factor in the appropriate row to obtain the actual gas concentration. For example, if

you are detecting pentane and the display reads 10% LEL on the combustible gas channel, you actually have $10\% \text{ LEL} \times 1.56 = 15.6\% \text{ LEL}$ pentane present.

Table 3: LEL Hydrocarbon Conversions

Gas	LEL Conversion Factor (Methane Calibration)	Gas	LEL Conversion Factor (Methane Calibration)
Acetone	1.79	Iso Butane	1.47
Acetylene	1.92	MEK	2.27
Benzene	2.00	Methane	1.00
Ethane	1.09	Methanol	1.92
Ethanol	2.50	Pentane	1.56
Ethylene	1.06	Propane	1.35
Heptane	2.50	Propylene	1.32
Hexane	2.08	Toluene	3.13
Hydrogen	1.25	Xylene	4.27
IPA	2.78		

CO with H₂S Response Configuration

Some applications may require the user to know if H₂S is present while monitoring with a Gas Tracer. The Gas Tracer does not have an H₂S sensor installed but if the charcoal filter is removed from the CO sensor, it will respond to H₂S.

Since the CO sensor cannot distinguish between CO and H₂S, the CO channel reading on the display could be a mix of CO and H₂S.

If the environment you are monitoring is completely free of CO, there is an approximate response factor that varies from sensor to sensor that can be used. The CO sensor's response to H₂S is 5 times greater than the actual H₂S concentration. For example, if the CO channel reading is 25 ppm, the actual H₂S concentration is 5 ppm. This approximation is not applicable if CO is present in the monitoring environment.

NOTE: If your Gas Tracer is configured to respond to both H₂S and CO, be sure to calibrate the CO channel using CO.

Snap Log Mode, Normal Operation

NOTE: For instructions to take snap log data if using the Gas Tracer in Leak Check Mode, see “Snap Log Mode, Leak Check Mode Operation” on page 109.

The snap logging function in Snap Log Mode allows the user to record data at a specific time and have it saved to the data logger. The data is assigned a snap log ID and is saved with the station ID that was in use when the data was taken.

To enter Snap Log Mode and record snap log data:

1. Turn the Gas Tracer on as described in “Turning On the Gas Tracer, Normal Mode Only” on page 20. Press and hold the (SHIFT)▼ button, then press and hold the AIR▲ button and hold both until you hear a beep. The unit will cycle through the following screens.

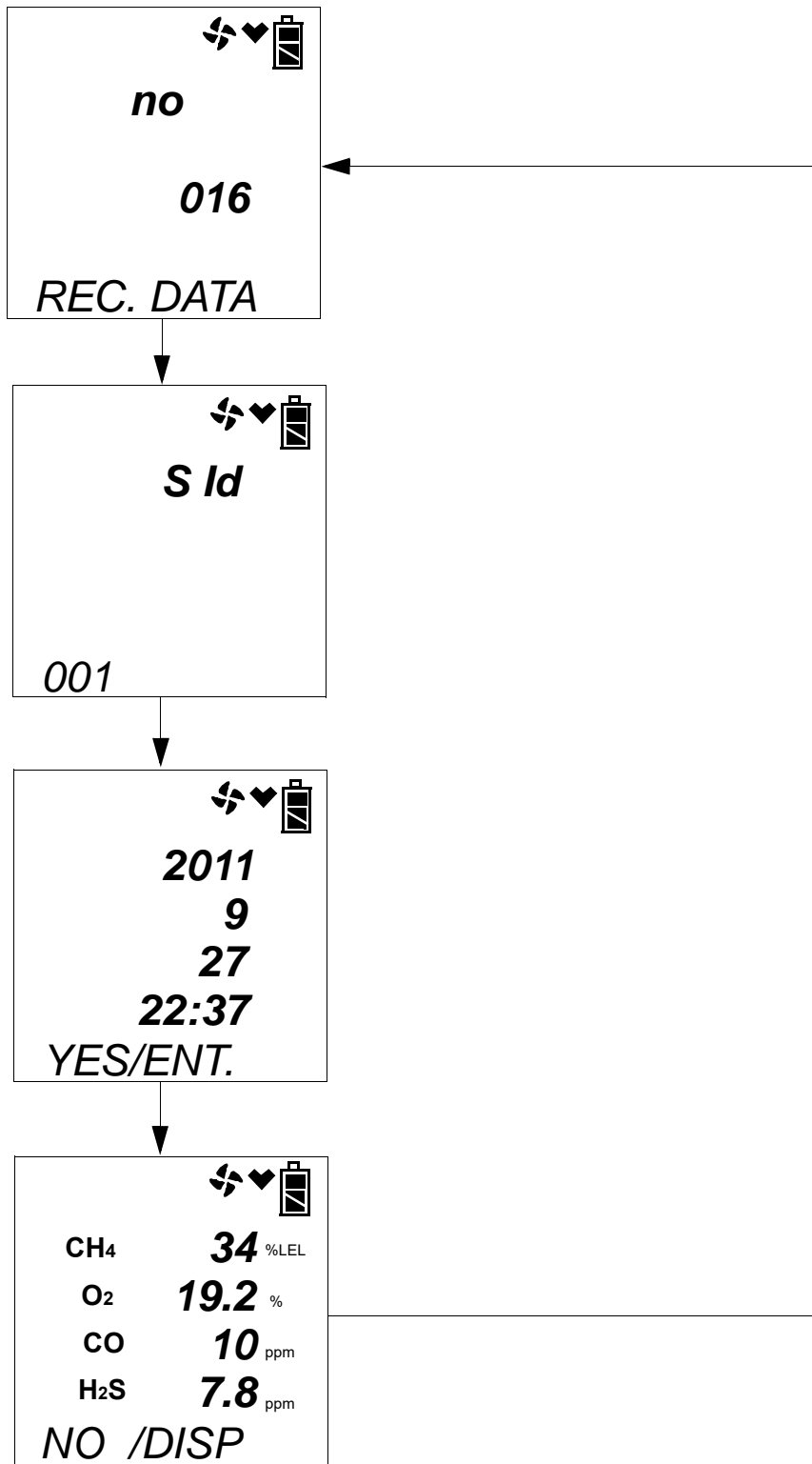

The first screen displays what snap log ID will be given to this particular set of data. This ID number increases sequentially with each set of snap log data taken. The second screen displays what Station ID will be associated with this snap log. The third screen displays the year, month, day, and time of the snap log, and that

you should press the POWER ENTER button to save a set of snap log data. The fourth screen displays the current gas readings, and that you should press the DISPLAY (ADJ) button to exit Snap Log Mode without saving a set of snap log data.

2. You can change the Station ID to be used with the snap log by pressing the (SHIFT)▼ button and then pressing the DISPLAY (ADJ) button. The Station ID Select Screen will appear and the current Station ID will be flashing.

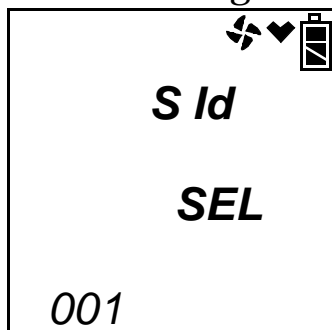

3. Use the (SHIFT)▼ and AIR▲ buttons to scroll to the desired station ID, then press and release the POWER ENTER button to return to the Snap Logging Screen sequence.

To return to the Snap Logging Screen sequence without changing the station ID, press and release RESET SILENCE.

4. To take a snap log of the current gas readings, press and release the POWER ENTER button. The unit will display **SAVED** along the bottom of the screen before returning to the Snap Logging Screen sequence.



To exit Snap Log Mode without taking a snap log or when you are finished recording snap logs, press and release the DISPLAY (ADJ) button. The unit will immediately return to the Normal Operation Screen.

5. The data recorded in Snap Log Mode can be viewed in Display Mode. See “Snap Logging Screen” on page 56 for more information.

Measuring Mode, Alarms

This section covers alarm indications in Measuring Mode. It also tells you how to reset the Gas Tracer after an alarm has occurred and how to respond to an alarm condition.

NOTE: False alarms may be caused by radio frequency (RF) or electromagnetic (EMI) interference. Keep the Gas Tracer away from RF and EMI sources such as radio transmitters or large motors.

Alarm Indications

CAUTION: *If the combustible channel is set for %volume only, then there are no gas alarms for any detection channel. See “HC Range Screen” on page 46.*

The Gas Tracer will sound an alarm, the unit will vibrate, and the LED arrays will flash when one of the target gas concentrations rises above the Warning level, or in the case of oxygen, falls below the Low Alarm setting for that gas.

The Gas Tracer also sounds an alarm, vibrates, and flashes the LED arrays when the Alarm level is reached for combustible gas and CO, when the concentration of oxygen rises above the High Alarm level, and when the STEL and TWA alarm points are reached for CO.

When a failure condition occurs, such as a sensor failure, low flow, or dead battery condition, the unit will also sound an alarm, flash the LED arrays, and vibrate.

The table below summarizes the types of alarms produced by the Gas Tracer.

Table 4: Alarm Types and Indications

Alarm Type	Visual Indications	Other Indications
Low Alarm Concentration of gas rises above the Warning level, or falls below the Low Alarm level for O ₂ .	<ul style="list-style-type: none">• WARNING appears below the gas list.• Reading for the gas in alarm flashes• Alarm LED arrays flash• Backlight turns on	<ul style="list-style-type: none">• Buzzer sounds alternating between a low and high pitch• Vibrator pulses

Table 4: Alarm Types and Indications

Alarm Type	Visual Indications	Other Indications
<p>High Alarm</p> <p>Concentration of gas rises above the Alarm level, or rises above the High Alarm level for O₂.</p>	<ul style="list-style-type: none"> • ALARM appears below the gas list. • Reading for the gas in alarm flashes • Alarm LEDs flash faster than warning indication • Backlight turns on 	<ul style="list-style-type: none"> • Buzzer sounds alternating between low and high pitch faster than warning indication • Vibrator pulses faster than warning indication
<p>TWA or STEL</p> <p>Concentration of CO rises above the TWA or STEL alarm point setting.</p>	<ul style="list-style-type: none"> • TWA or STEL appears below the gas list. • Alarm LEDs flash • Back light turns on 	<ul style="list-style-type: none"> • Buzzer sounds alternating between a low and high pitch at the same rate as warning indication • Vibrator pulses at same rate as warning indication
<p>Over Range*</p>	<ul style="list-style-type: none"> • Gas reading replaced by brackets flashing at same rate as alarm indication □□□□□ • Alarm LEDs flash at same rate as alarm indication • Back light turns on. • OVER appears below the gas list. 	<ul style="list-style-type: none"> • Buzzer sounds alternating between a low and high pitch at same rate as alarm indication • Vibrator pulses at same rate as alarm indication
<p>Low Flow*</p>	<ul style="list-style-type: none"> • The display indicates FAIL LOW FLOW • The Alarm LED's flash 	<ul style="list-style-type: none"> • Buzzer sounds a double pulsing tone (two pulses in quick succession)
<p>Low Battery Warning*</p>	<ul style="list-style-type: none"> • Battery icon blinks 	<ul style="list-style-type: none"> • None
<p>Dead Battery Alarm*</p>	<ul style="list-style-type: none"> • Gas readings replaced by FAIL • Fan symbol disappears • BATTERY displayed along bottom of screen • Alarm LED arrays flash 	<p>Buzzer sounds a double pulsing tone (two pulses in quick succession)</p>

Table 4: Alarm Types and Indications

Alarm Type	Visual Indications	Other Indications
Sensor Failure*	<ul style="list-style-type: none"> • FAIL appears at the bottom of the display and the failed sensor(s) are indicated • Alarm LED arrays flash 	Buzzer sounds a double pulsing tone (two pulses in quick succession)
Clock Failure*	<ul style="list-style-type: none"> • FAIL CLOCK appears on the display • Alarm LED arrays flash 	Buzzer sounds a double pulsing tone (two pulses in quick succession)
System Failure*	<ul style="list-style-type: none"> • FAIL SYSTEM appears on the display • Alarm LED arrays flash 	<ul style="list-style-type: none"> • Buzzer sounds a double pulsing tone (two pulses in quick succession) • A failure code appears
Microprocessor Failure* <ul style="list-style-type: none"> • NOTE: The unit will not operate if this alarm occurs. 	<ul style="list-style-type: none"> • Heart indicator is steadily on or not on at all 	<ul style="list-style-type: none"> • None
*This alarm can also occur in Bar Hole Mode		

Resetting and Silencing Alarms

You can set the Gas Tracer’s gas alarms as latching or self-resetting alarms (See “Updating the Alarm Latching Setting” on page 143) and the buzzer operation as silenceable or not silenceable (See “Updating the Alarm Silence Setting” on page 144).

- Self-resetting alarms (**LATCHING** set to OFF)

Self-resetting alarms automatically shut off and reset when the gas reading falls below (or rises above for an oxygen low alarm) the alarm setting. You cannot silence or reset self-resetting alarms.

- Latching alarms (**LATCHING** set to ON)

You can set latching alarms with or without Alarm Silence (see “Updating the Alarm Silence Setting” on page 144).

With ALRM SLNC On and LATCHING On:

When the Gas Tracer goes into a gas alarm, press the RESET SILENCE button to silence the buzzer. If the gas concentration was still above the alarm level when the button was pressed, the LEDs continue to

flash, and the Gas Tracer continues to display the current alarm level.

The gas reading must fall below (or rise above for an oxygen low alarm) the low alarm setting before you can reset the alarm. Press the RESET SILENCE button to reset the alarm. The LEDs turn off and the Gas Tracer alarm indications on the display turn off.

With ALRM SLNC OFF and LATCHING ON:

The gas reading must fall below (or rise above for an oxygen low alarm) the low alarm setting before you can reset the alarm. Press the RESET SILENCE button to reset the alarm. The LEDs and buzzer turn off and the Gas Tracer alarm indications on the display turn off.

NOTE: With ALRM SLNC set to OFF in Maintenance Mode, you cannot silence the buzzer while the gas reading is above (below for an oxygen Low Alarm) the low alarm setting.

Responding to Alarms

This section describes response to gas, over range, battery, and sensor failure alarms.

Responding to Gas Alarms

1. Determine which gas alarm has been activated.
2. Follow your established procedure for an increasing gas condition or a decreasing oxygen condition.
3. If necessary, reset the alarm using the RESET SILENCE button once the alarm condition has been cleared.

Responding to Over Range Alarms

WARNING: An over range alarm may indicate an extreme combustible gas, toxic gas, or oxygen concentration. Confirm a normal condition with a different Gas Tracer or with another gas detecting device.

1. Determine which gas alarm has been activated.
2. Follow your established procedure for an increasing gas condition.
3. Reset the alarm using the RESET SILENCE button once the alarm condition has cleared.
4. Calibrate the Gas Tracer as described in the calibration section of this manual.
5. If the over range condition continues, you may need to replace the

- sensor that has triggered the over range alarm.
6. If the over range condition continues after you have replaced the sensor, contact RKI Instruments, Inc. for further instructions.

Responding to Battery Alarms

WARNING: The Gas Tracer is not operational as a gas monitoring device during a dead battery alarm. Take the Gas Tracer to a non-hazardous area and replace or recharge the batteries as described in “Replacing or Recharging the Batteries” on page 173.

The Gas Tracer is fully functional during a low battery warning. However, only a limited amount of operating time remains, approximately 1 - 2 hours. The amount of time depends on how often the LCD backlight is used and how often the unit is responding to alarm conditions. Recharge the battery pack or replace the alkaline batteries as soon as possible as described in “Replacing or Recharging the Batteries” on page 173.

NOTE: Alarms and the back light feature consume battery power and reduce the amount of operating time remaining.

Responding to Sensor Failure Alarms

1. Determine which sensor has triggered the sensor failure alarm.
2. Try calibrating the sensor first, as described in “Calibration Mode” on page 61 before replacing it.
3. If the sensor failure continues, replace the sensor as described in “Replacing a Sensor” on page 182.
4. If the sensor failure condition continues after you have replaced the sensor, contact RKI Instruments, Inc. for further instructions.

Responding to Clock Failure Alarm

This alarm occurs if the internal unit date has been changed to something unreasonable like 15/34 (month/day).

1. Press and release the RESET SILENCE button to continue into normal operation.

CAUTION: There will be no datalogging function if you operate the instrument after a clock failure.

2. Attempt to change the date using the **DATE** menu time in

Maintenance Mode. See “Updating the Date and Time Settings” on page 118.

3. If the date cannot be set correctly, contact RKI Instruments, Inc. as soon as possible.

Responding to System Failure Alarms

1. If a system failure occurs, the system failure screen will display an error code as shown below:

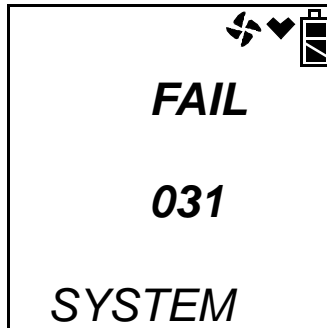

2. The error code meanings are shown below:

Table 5: Error Code Explanation

Error Code	Explanation
000	MPU failure
010	RAM failure
021	EEPROM failure
031	FLASH memory failure

3. If the error code is anything but 031 as shown above, the instrument cannot be used. Contact RKI Instruments, Inc. as soon as possible.

If the error code is 031, you may press and release the RESET SILENCE button to continue to normal operation if the instrument must be used temporarily.

CAUTION: *There will be no datalogging function if you operate the instrument after a 031 system failure. Contact RKI Instruments, Inc. as soon as possible.*

Responding to Microprocessor Failure

If your unit experiences a microprocessor failure, the heart symbol at the top of the screen will be steadily on or steadily off. The unit cannot be used in this case. Contact RKI Instruments, Inc. as soon as possible.

Inert Mode

Inert Mode is used to measure the combustible gas and/or oxygen level in a purged environment. In order for the instrument to operate in Inert Mode, the oxygen alarm must be set to H-HH operation in which both alarms are increasing. The oxygen Warning and Alarm points are factory set at 5.0% and 10.0%.

It is recommended that the %volume sensor be installed in a unit that is used to monitor combustible gas during Inert Mode operation since it does not require oxygen to work properly. The catalytic LEL sensor does not operate at oxygen concentrations below 10% volume. If it is necessary to use the catalytic LEL sensor during Inert Mode operation, a dilution fitting must be installed. Installing a dilution fitting will affect the oxygen reading since you're introducing oxygen into the sample.

Alarms

The oxygen channel alarm points in Inert Mode are different from those in Normal Mode. All other alarm point settings remain unchanged.

Since the application for Inert Mode is to detect a rising oxygen level in purged environments, both oxygen alarms are set to rising. The factory set alarm point is 5.0% volume for the Warning and 10.0% volume for the Alarm. These alarm points are user adjustable in Maintenance Mode. See "Updating the Alarm Point Settings" on page 146 for instructions to set the alarm points.

Start Up and Operation

1. With the oxygen alarm pattern set to H-HH, start up the Gas Tracer as described in "Turning On the Gas Tracer, Normal Mode Only" on page 20.

2. Once the warm up sequence is complete, the Normal Operation Screen will display and INERT will appear along the bottom of the display.

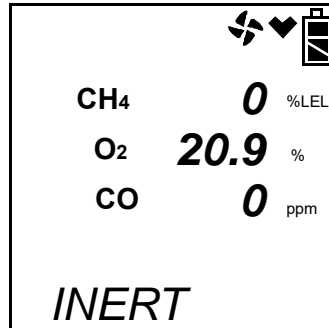

3. Since the oxygen concentration in fresh air is above both oxygen alarm points, the Gas Tracer will go into alarm if turned on in a fresh air environment.

Display Mode

This section describes using the Gas Tracer in Display Mode. With the Gas Tracer in Display Mode, you can:

- set the combustible gas channel range
- display peak readings
- display STEL and TWA readings (*CO only*)
- display full scale, warning, alarm, STEL (*CO only*), and TWA (*CO only*) values
- display time in operation
- display the date and time
- display remaining log time
- clear the data logger
- turn the pump on or off
- select a user ID
- select a station ID
- display snap logging data
- turn peak bar function on or off

To enter Display Mode, press and release the DISPLAY (ADJ) button while in Measuring Mode. To scroll from one screen to the next press and release the DISPLAY (ADJ) button.

NOTE: Each screen displays for 20 seconds. If you do not press the DISPLAY (ADJ) button to scroll to the next screen or press the POWER ENTER button to enter an item within 20 seconds, the Gas Tracer automatically returns to Measuring Mode.

HC Range Screen

This screen displays only if your Gas Tracer is equipped with both the catalytic % LEL combustible sensor and the TC % volume combustible sensor. It allows you to select the display units for the combustible channel as % LEL/% volume autoranging or % volume. If autoranging is selected, the combustible gas reading will be displayed in % LEL up to 100% LEL, which is equivalent to 5% volume for methane (CH₄). Above 100% LEL, it will be displayed in %volume. If % volume is selected, the combustible gas reading will be displayed in % volume only.

CAUTION: *If the combustible channel is set for % volume only, then there are no gas alarms for any detection channel and NO ALARM will appear in the upper left corner of the screen when you return to Normal Operation.*

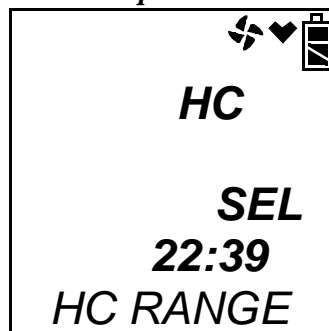

To update the HC range setting:

1. After entering Display Mode and arriving at the HC Range Screen, press and release the POWER ENTER button. The current setting will appear at the bottom of the LCD.
2. Use the AIR▲ or (SHIFT)▼button to change the setting.
3. Press the POWER ENTER button to save the change.
4. Press the DISPLAY (ADJ) button to advance to the next screen.

Peak Screen

The Peak Screen displays the highest (lowest for O₂) concentrations detected since the Gas Tracer was turned on. Peak readings are stored in the Gas Tracer's memory until a higher level is detected, the peak reading is reset, or the Gas Tracer is turned off.

The lunch break feature enables the Gas Tracer to remember peak readings when it is turned off so it can continue them when it is turned on again. See "Turning On the Gas Tracer, Normal Mode Only" on page 20. To reset the peak readings during operation, press and hold the RESET SILENCE button for a few seconds while in the peak screen.

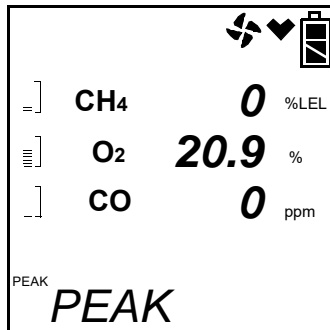

STEL Screen

The STEL Screen displays the short-term exposure limit (STEL) readings *for CO only*. The STEL reading is the average reading *during the last 15 minutes*.

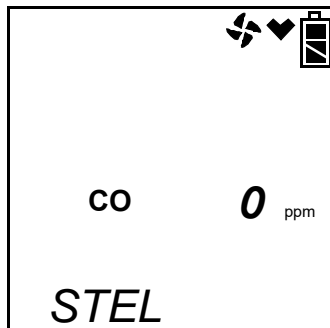

TWA Screen

The TWA Screen displays the time-weighted average (TWA) readings *for CO only*.

The TWA reading is the average reading *during the last 8 hours*. If 8 hours have not elapsed since the last time the TWA reading was cleared, the average is still calculated over 8 hours. The missing time is assigned a 0 value for readings.

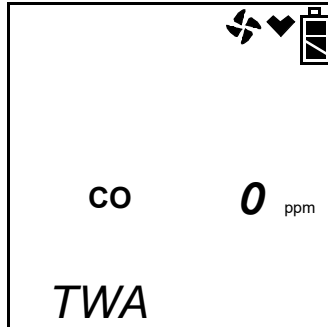

Alarm Points Screen

The Alarm Points Screen allows you to view each channel's alarm settings for full scale, warning, alarm, STEL (for CO only), and TWA (for CO only). The bottom line of the screen will alternate between ALARM--P, NO /DISP, and YES/ENT.

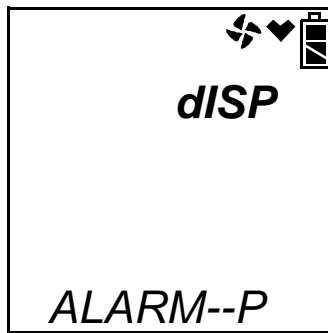

Press the POWER ENTER button to proceed to view the full scale settings. Use the AIR▲ or (SHIFT)▼ buttons to scroll through screens showing the different settings.

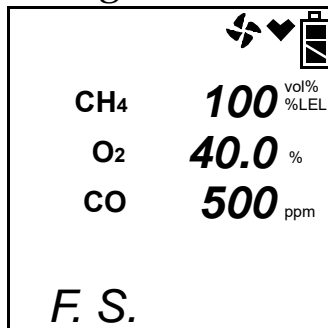

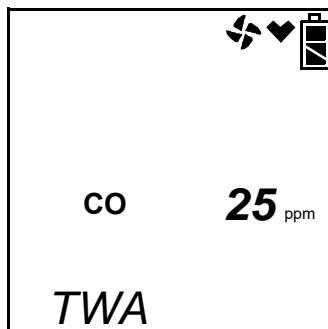
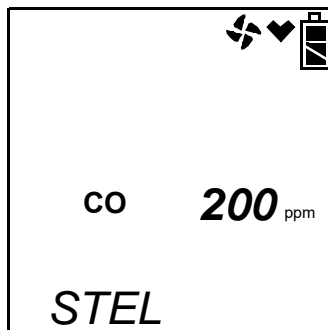
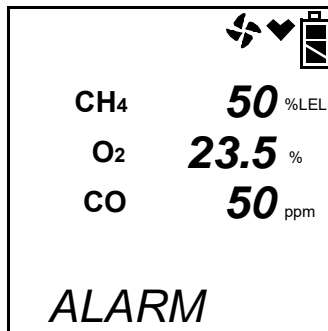
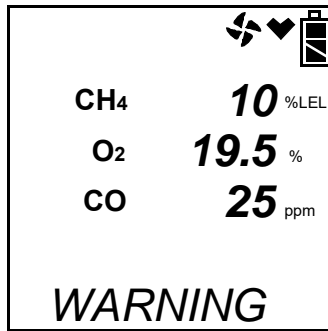

Pressing and releasing POWER ENTER while in a settings screen will cause the instrument to simulate that condition. The buzzer, LEDs, and vibration will activate. Press and release POWER ENTER again to stop the simulated alarm.

Operation Time Screen

The operation time screen displays the time in minutes since the Gas Tracer was last turned on. The operation time may be continued from the last time the Gas Tracer was in operation by using the lunch break option. See “Turning On the Gas Tracer, Normal Mode Only” on page 20.

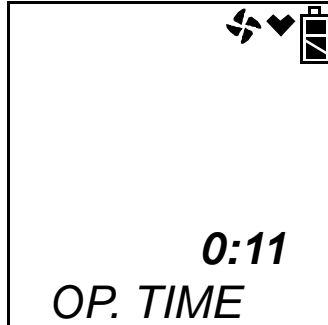

Date/Time Screen

The date/time screen displays the current date and time with the order being year, month, day, time.

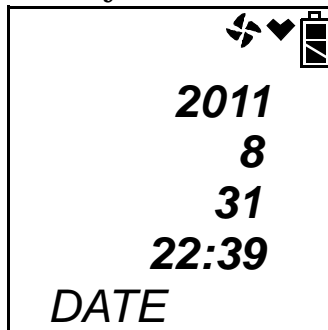

Remaining Log Time Screen

The remaining log time screen displays the time remaining until the data logger memory is full. The remaining log time depends on how often the Gas Tracer stores data to the data log, how many channels are active, and how often the Gas Tracer is turned on and off.

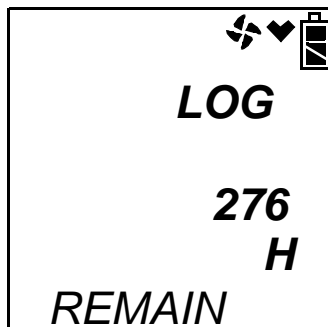

The table below illustrates how much data logging time is available for the various interval times. It assumes that the unit is set up with all 5 sensors and there are no alarm occurrences.

Table 6: Data Logging Capacity, 5 Sensor Gas Tracer

Interval Time	Data Logging Time
10 seconds	10 hours
20 seconds	20 hours
30 seconds	30 hours
1 minute	60 hours
3 minutes	180 hours
5 minutes	300 hours
10 minutes	600 hours

Clear Data Logger Screens

CAUTION: *Once you clear the data logger, you cannot retrieve any data previously stored in the data logger.*

NOTE: This item appears in Display Mode only if the **DLOG DSP** menu item in Maintenance Mode is turned ON. The factory setting for **DLOG DSP** is ON.

The clear data logger screens allow you to clear the data logger storage. You can set the Gas Tracer to overwrite the oldest data when the data log is full. See “Updating the Datalog Overwrite Setting” on page 154. The bottom line of the screen alternates between LG CLEAR, NO /DISP, and YES/ENT.

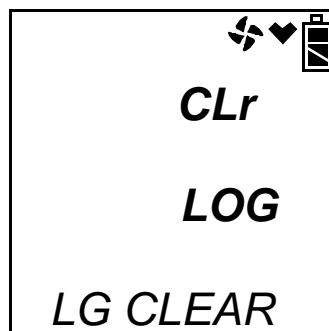

To clear the data log:

1. With the above screen displayed, press and release the POWER ENTER button. The instrument will ask you to confirm that you want to clear the data log and CLr LOG will be flashing. The

bottom line of the screen alternates between CONFIRM?, YES/ENT., AND NO /DISP.

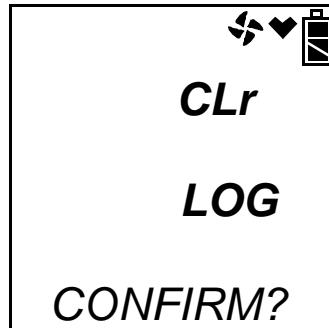

2. To cancel the clear data log and return to the Clear Data Logger Screen in Display Mode, press and release DISPLAY (ADJ).

To continue with the clear data log, press and release POWER ENTER.

3. The Gas Tracer displays 4 dashes and as the Gas Tracer clears the data, the dashes disappear. When the last dash is gone, the Gas Tracer has been cleared and the remaining log time value is reset.

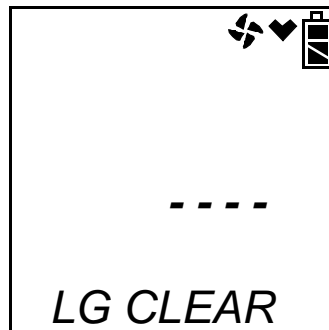

Pump OFF Screen

WARNING: The Gas Tracer is not a gas monitoring device while the pump is off.

NOTE: This item appears in Display Mode only if the **POFF DSP** menu item in Maintenance Mode is turned ON. The factory setting for **POFF DSP** is OFF.

The Gas Tracer pump can be turned on and off in this screen. The bottom line of this screen alternates between PUMP OFF, NO /DISP, and YES/ENT. This feature can be used to conserve battery life if there is a significant period of time until the next gas monitoring task, but you do not want to wait for the warmup sequence to complete if you turn the instrument off and on again.

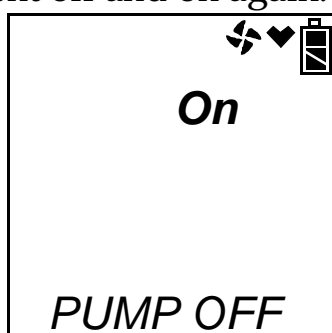

In this screen, press POWER ENTER to turn the pump off. The fan in the upper right corner of the screen will disappear. Once the pump is off, you cannot exit this screen and return to normal operation or continue in Display Mode until you turn the pump back on. To turn the pump back on and continue in Display Mode or return to Normal Operation, press the POWER ENTER button again.

User ID Screen

This screen always appears in Display Mode, regardless of the **ID DISP** setting in the Maintenance Mode menu. Each user ID can contain up to 16 characters but only the first 8 of those characters are visible in the instrument. Be sure that all user IDs are distinguishable from each other by viewing only the first 8 characters. For more information, see the GX-2012 Data Logger Management Program manual. Uppercase letters, numbers, asterisks (*), dashes (-), and a blank space are available characters. The Gas Tracer can store 128 user IDs. The bottom line of this screen alternates between YES/ENT., the current user ID, and NO /DISP.

Use this screen to identify or change the user. The user ID provides a way to identify the user during a data logging session. The user ID is

saved to the data logger for that session when you turn off the Gas Tracer or change users during operation. This allows you to change the user ID during operation and have each user ID that was used during an operating session saved for the corresponding data.

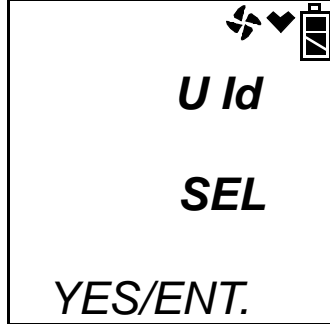

NOTE: As shipped from the factory, the user ID on this screen is shown as -- -- -- -- -- until you enter this screen and select a user ID.

To change a user:

1. After entering Display Mode and proceeding to the User ID screen, press and release the POWER ENTER button. The bottom line of this screen alternates between YES/ENT, the current user ID, and NO /DISP.

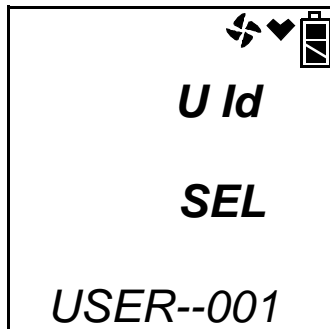

2. Use the AIR▲ and (SHIFT)▼ buttons to scroll through the 128 possible user IDs.
3. Press the POWER ENTER button to select a user ID.

Station ID Screen

This screen always appears in Display Mode, regardless of the **ID DISP** setting in the Maintenance Mode menu. Each station ID can contain up to 16 characters but only the first 8 of those characters are visible in the instrument. Be sure that all station IDs are distinguishable from each other by viewing only the first 8 characters. For more information, see the GX-2012 Data Logger Management Program manual. The bottom line of the screen alternates between YES/ENT., the current station ID, and NO /DISP. Uppercase letters,

numbers, asterisks (*), dashes (-), and a blank space are available characters. The Gas Tracer can store 128 station IDs.

Use this screen to identify or change the station. The station ID provides a way to identify the station during a data logging session. The station ID is saved to the data logger for that session when you turn off the Gas Tracer or change stations during operation. This allows you to change the station ID during operation and have each station ID that was used during an operating session saved for the corresponding data.

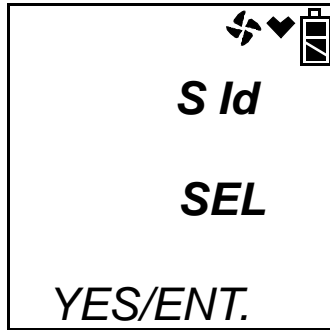

NOTE: As shipped from the factory, the station ID on this screen is shown as -- -- -- -- -- until you enter this screen and select a station ID.

To change a station:

1. After entering Display Mode and proceeding to the Station ID screen, press and hold the POWER ENTER button. The bottom line of this screen alternates between YES/ENT., the current user ID, and NO /DISP.

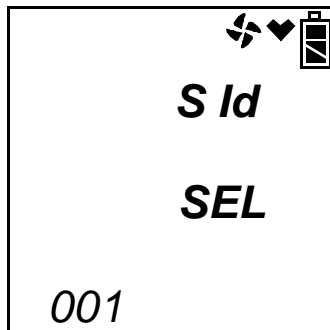

2. Use the AIR▲ and (SHIFT)▼ buttons to scroll through the 128 possible station IDs.
3. Press the POWER ENTER button to select a station ID.

Snap Logging Screen

The Snap Logging Screen allows you to view data from previous snap logs. For information on how to use the snap logging feature, see “Snap Log Mode, Normal Operation” on page 35 or “Snap Log Mode, Leak Check Mode Operation” on page 109.

1. To view snap logging data, use the AIR▲ and (SHIFT)▼ buttons to scroll to the Snap Logging Screen. The bottom line of this screen alternates between REC. DATA, NO /DISP, and YES/ENT.

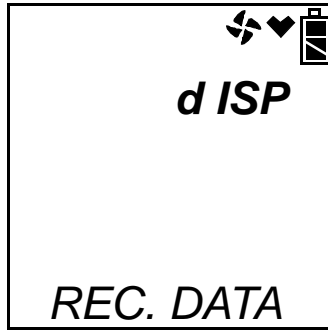

2. Press and release the POWER ENTER button. If no snap logs have been performed, the following screen will appear. Press and release the DISPLAY (ADJ) button to return to the Snap Logging Screen.

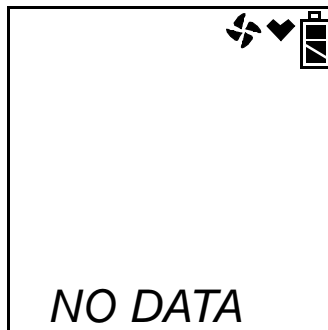

3. If snap logs have been performed in either Normal Operation or Leak Check Mode Operation, one of the following screens will appear. LEAK CK MODE will appear in the upper left corner of Leak Check Mode Operation data to indicate that the snap log was taken during Leak Check Mode Operation.

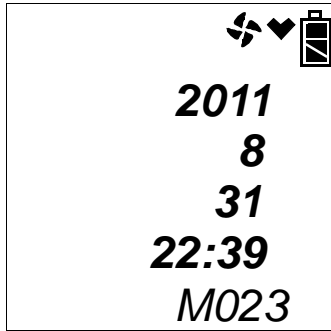

Normal Operation
Snap Log

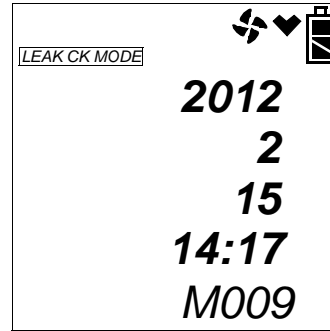

Leak Check Mode Operation
Snap Log

This screen indicates the year, month, day, and time that the most recent snap log was taken. The number along the bottom of the screen indicates the snap log ID number. The first snap log that is taken is given an ID of M001. The next snap log ID is M002. The ID number increases sequentially with each set of snap log data. Use the AIR▲ and (SHIFT)▼ buttons to scroll through different snap log IDs and view what time and day they were taken. Snap log data that was taken in Leak Check Mode operation will have two snap log ID numbers. One number is for the base reading and the other is for the peak reading.

4. To view the data in a snap log ID, press and release the POWER ENTER button. You can also go back and forth between the ID and data screens by pressing and releasing the POWER ENTER button.

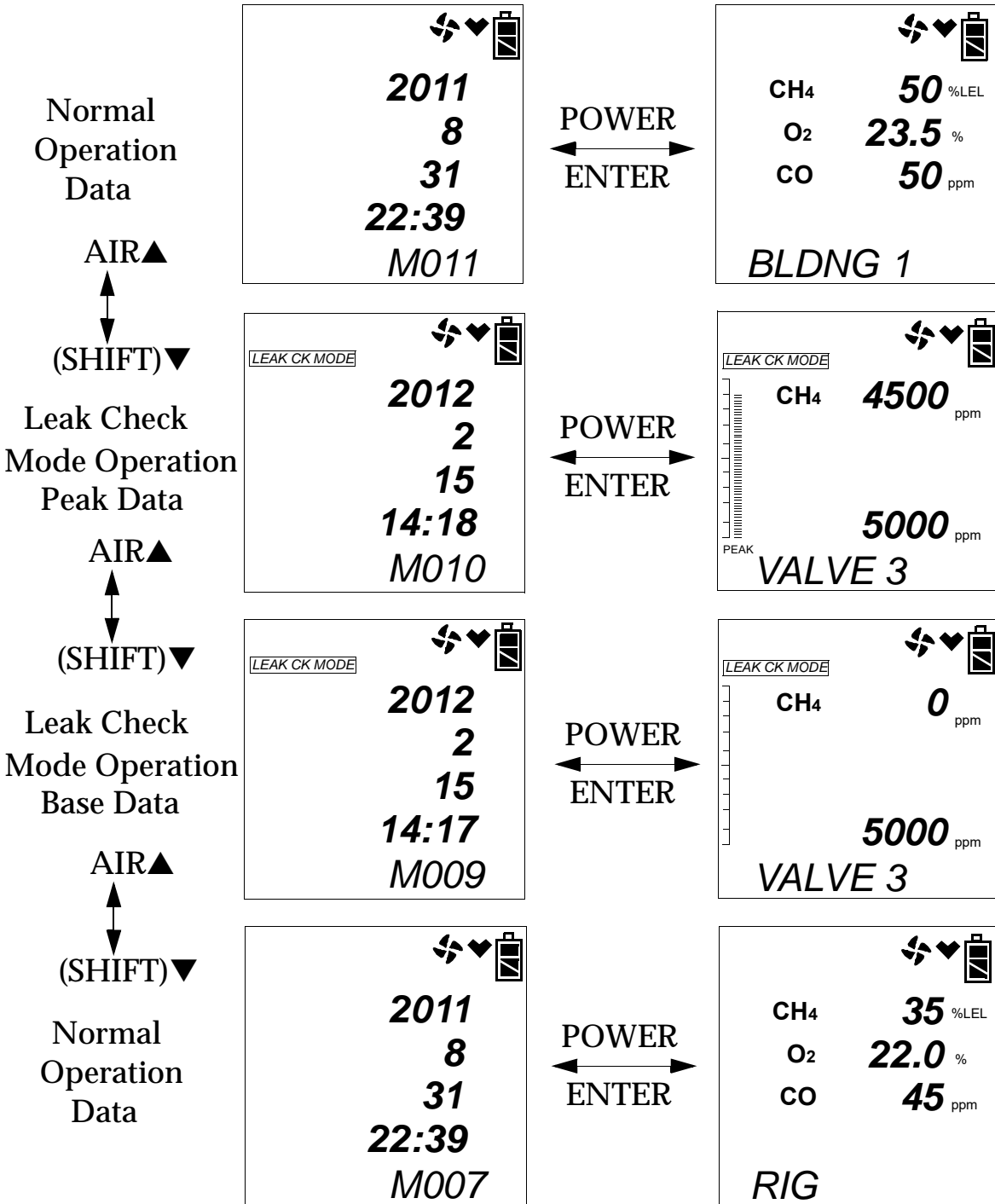

The gas readings that were taken during the snap log are displayed and the Station ID that was in use during the snap log is displayed along the bottom of the screen. Snap log data that was taken in Leak Check Mode operation will have 2 sequential screens that are part of one data set. One screen is for the base reading and the other screen is for the peak reading. The peak reading value will have PEAK displayed below the peak bar. If a base data point appears without a peak data point after it, it is because a peak data point was not taken. You can use the AIR▲ and (SHIFT)▼ buttons to scroll through the different snap logs. The gas readings and station ID will change but the snap log ID is not visible from this screen.

Peak Bar Select Screen

The Peak Bar Select Screen allows you to turn the peak bar on or off. If the function is turned on, the peak bar appears along the left side of the screen during Normal Operation and on the Peak Screen in Display Mode. It shows the peak readings for each channel in bar graph format. The bottom line of this screen alternates between the current setting, NO /DISP, and YES/ENT.

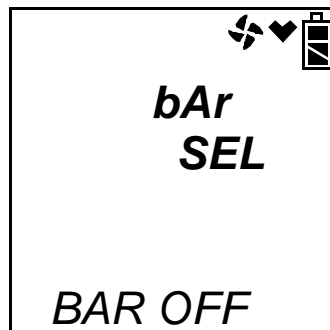

To adjust the peak bar selection:

1. Use the DISPLAY (ADJ) button to scroll to the Peak Bar Select Screen. The screen indicates the current setting.

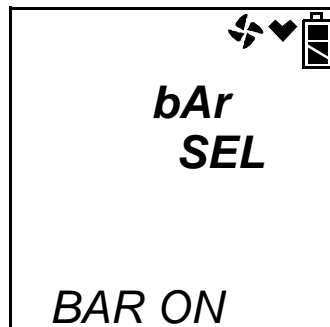

2. Press and release the POWER ENTER button.

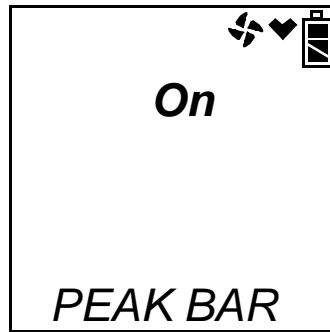

3. Use the AIR▲ and (SHIFT)▼ buttons to make your selection and press and release the POWER ENTER button.

Data Logging

NOTE: The Gas Tracer logs data while in Normal Mode or in Bar Hole Mode. If the Gas Tracer is used in Leak Check Mode, no downloadable data will be logged.

The Gas Tracer features the ability to log data to its internal memory and download it to a computer via the infrared communications port located just below the RESET SILENCE button. It logs gas readings during normal operation, alarm data, and calibration data.

NOTE: The data logging function is separate from the snap logging function. For a description of the snap logging function, see “Snap Log Mode, Normal Operation” on page 35.

To utilize the Gas Tracer’s downloading capability, you will need the Gas Tracer downloading software and a computer with an infrared port or a USB port that runs one of the following operating systems: Windows 7, Windows 8, or Windows 10. If your computer has an infrared port, then no additional accessories are needed to download data from the Gas Tracer. If your computer does not have an infrared port but does have a USB port, a USB/IrDA adapter cable can be used to download data from the Gas Tracer using a USB port. The downloading software is available at www.rkiinstruments.com/gx2012. The USB/IrDA adapter cable is also available from RKI.

For a complete description of the downloading software and procedures for downloading data to a computer, see the GX-2012 Data Logger Management Program Operator’s Manual.

SDM-2012

The Gas Tracer can be used with the SDM-2012 if desired. The SDM-2012 can charge the instrument if the lithium ion battery pack is being used. It can also bump test, calibrate, and retrieve saved data. The SDM-2012 can be operated as a single, stand-alone unit or can be used with up to 9 other SDM-2012s and operated using a computer. For more information about the operation of the SDM-2012, see the SDM-2012 operator's manual.

Calibration Mode

Calibration mode allows you to calibrate the Gas Tracer's sensor response, bump test the unit, and calibrate the PPM sensor.

The unit should be calibrated periodically. The optimum frequency of calibration depends heavily on how the Gas Tracer is used. For example, instruments used daily may need to be calibrated weekly or monthly, while instruments that are used only a few times a year may need to be calibrated before each use. Typical calibration frequencies range from monthly to quarterly.

You can program the Gas Tracer to notify you when it is due for calibration. See "Updating the Calibration Reminder Setting" on page 156.

Calibration/Bump Test Supplies and Equipment

To calibrate or bump test the Gas Tracer, you will need:

- Known calibrating samples of the gases being detected. The combustible and toxic gas samples should have concentrations in approximately the middle of the range of detection. An oxygen-free source, such as 100% nitrogen is recommended for setting the oxygen zero when using single calibration.
- A demand-flow regulator to provide adequate sample gas flow
- Non-absorbent tubing
- Humidifier tube (for calibration of ppm sensor)

CAUTION: *If you are using a calibration kit that includes a gas bag and a fixed flow regulator or dispensing valve, do not apply gas directly to the Gas Tracer with the regulator or valve or damage to the pump will result. See “Appendix A: Calibrating or Bump Testing with a Sample Bag” on page 189 for instructions to properly use a gas bag kit.*

To calibrate the %LEL, Oxygen, and CO sensors at the same time, automatically, with no need for a zero-oxygen source, you can use the auto calibration feature with a 3-gas cylinder. This section includes instructions for auto calibration and bump testing with a demand-flow regulator, a 3-gas cylinder, and a %volume methane cylinder. This section also includes instructions for calibrating one channel at a time using single calibration.

NOTE: If the combustible gas channels are calibrated to a gas other than methane, use an appropriate multigas cylinder or use single calibration to calibrate the combustible channels.

Preparing for Calibration or Bump Test

Whether you will calibrate the Gas Tracer using auto calibration or single calibration or perform a bump test, you will need to set the fresh air readings first.

1. Find a fresh-air environment. This is an environment free of toxic or combustible gases and of normal oxygen content (20.9%).
2. Turn on the unit as described in “Turning On the Gas Tracer, Normal Mode Only” on page 20 or “Turning On the Gas Tracer in Normal Mode With All Modes Active” on page 26. Use the sample hose and probe.
3. With the unit on, perform a fresh air adjust by pressing and holding the AIR▲ button. The display prompts you to hold the AIR▲ button.



4. Continue to hold the AIR▲ button until the display prompts you to release it. The Gas Tracer will set the fresh air reading for all

- channels as it counts down from 8. If the combustible channel is set as %LEL only or vol% only, there is no countdown period. The fresh air reading is set immediately.
5. Install the demand flow regulator onto the calibration cylinder.
 6. Connect the sample tubing to the demand flow regulator.

Calibrating the Gas Tracer

From Measuring Mode, enter Calibration Mode by pressing and holding the (SHIFT)▼ button, then pressing the DISPLAY(ADJ) button and releasing both. If the unit prompts you for the password, enter it by using the AIR▲ and (SHIFT)▼ buttons to select each password number and then pressing and releasing POWER ENTER to confirm it and move on to the next number. To go back a number, press and release the RESET SILENCE button. The factory set password is the same as the factory set password for Maintenance Mode: 2102. You can change the password by entering the **PASSWORD** menu item in Maintenance Mode. See “Turning the Password Function On or Off” on page 167. If you enter an incorrect password, an error screen will display.

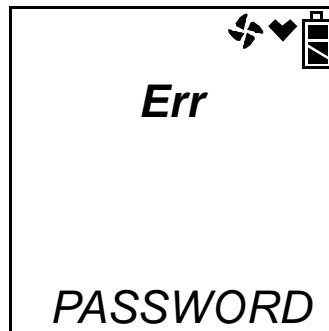

To return to normal operation, press and release the RESET SILENCE button. You may then try to reenter Calibration Mode.

MAINTENANCE will appear along the top of the screen once you have entered Calibration Mode. The first item in the calibration menu, AIR CAL, displays.

NOTE: The following screens illustrate a three-gas Gas Tracer with both a %LEL and %volume combustible gas sensor as examples only. Your Gas Tracer may display slightly different screens.

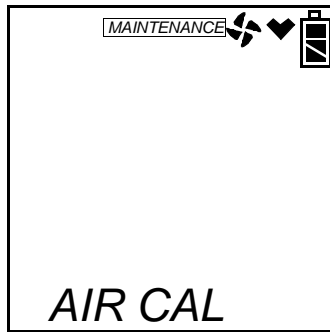

The Gas Tracer's calibration menu includes two methods of calibration:

- **Auto Calibration:** This method allows you to calibrate the combustible gas (%LEL sensor only), OXY, and CO sensors simultaneously. It is designed for use with the RKI 3-gas calibration cylinder and is the quickest and easiest method to calibrate the Gas Tracer. If installed, you may also calibrate the %volume sensor separately from the standard three.
- **Single Calibration:** This method allows you to calibrate one sensor at a time. Use this method if you are only calibrating one or two sensors, if you are calibrating only the %volume combustible sensor, or if you are not using the RKI 3-gas calibration cylinder.

NOTE: These methods only apply to the standard 3 sensors and the vol% sensor (if installed). The PPM sensor must be calibrated independently using PPM CAL. See “Calibrating and Bump Testing the PPM Combustible Sensor” on page 76 for instructions.

Calibrating with the Auto Calibration Method

This section describes calibration using the auto calibration method. To calibrate using the single calibration method, see “Calibrating with the Single Calibration Method” on page 67.

NOTE: If the combustible gas channels are calibrated to a gas other than methane, use an appropriate multigas cylinder or use single calibration to calibrate the combustible channels.

1. You may only calibrate either the standard 3 sensors or the %volume combustible sensor at a time. Once you are finished, you are returned to the initial AUTO CAL screen and must begin the auto calibration process again.
2. Use the AIR▲ and (SHIFT)▼ buttons to display the AUTO CAL

menu item, press and release the POWER ENTER button to display the calibration values screen. If you want to exit back to the main menu without completing a calibration, press and release the DISPLAY (ADJ) button.

3. Use the AIR▲ or (SHIFT)▼ buttons to alternate between the 3-gas and the %volume combustible gas calibration values screens.

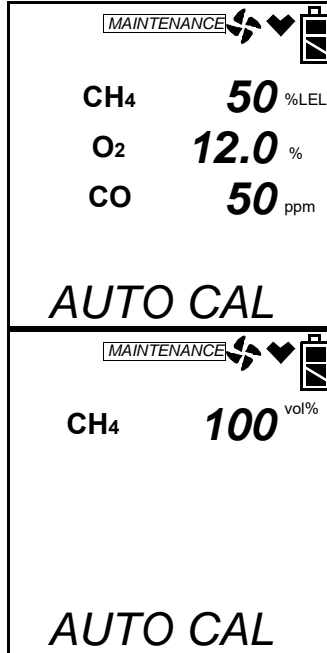

4. The gas concentrations displayed in the calibration values screens must match the gas concentrations listed on the calibration cylinders. If *all* concentrations match, go to step 12. If *one or more* concentrations do not match, continue with step 5.
5. To adjust the values on the screen, hold down the (SHIFT)▼ button, then press the DISPLAY(ADJ) button and release both. The %LEL sensor is shown here.

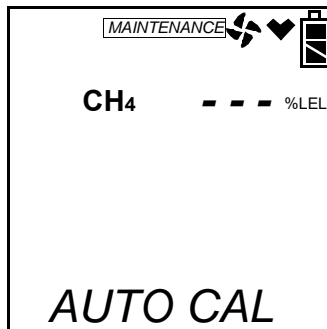

6. Use the AIR▲ and (SHIFT)▼ buttons to scroll through the sensors and select the sensor whose calibration gas value you want to adjust.
7. Press and release the POWER ENTER button. The sensor's

calibration gas value will begin to flash.

8. If necessary, use the AIR▲ and (SHIFT)▼ buttons to set the correct calibration gas value.
9. Press and release POWER ENTER button to save the change.
10. Repeat steps 6 through 9 to set the correct values for any additional sensors.
11. After the last calibration gas value is set, use the AIR▲ button to scroll to ESCAPE and press POWER ENTER to return to the calibration gas values screen.

NOTE: The RKI Three Gas Cylinder typically contains 12% O₂ by volume. Be sure to set the “OXY” reading to agree with the concentration listed on the cylinder’s label, not zero.

12. Use the AIR▲ or (SHIFT) ▼ button to select which sensor(s) you want to calibrate, the standard 3 sensors or the %volume combustible gas sensor.

The following instructions illustrate calibrating the standard 3 sensors first, then the %volume combustible gas sensor.

13. With the 3-gas calibration values screen displayed, press the POWER ENTER button. AUTO CAL begins to flash and the current gas readings are displayed. If you want to exit back to the main menu without completing a calibration, press and release the DISPLAY (ADJ) button.

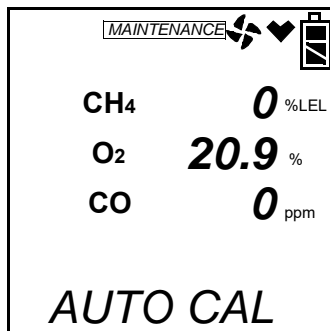

14. Connect the tubing from the demand flow regulator to the rigid tube on the probe. Allow the gas to flow for one minute.
15. Press and release the POWER ENTER button to set the calibration to the programmed values.

If all channels passed calibration, PASS displays along the bottom of the screen, then the calibration menu displays.

If any of the sensors cannot calibrate to the proper value, FAIL

displays along the bottom of the screen and the Gas Tracer lists the sensor(s) that failed to calibrate. In the example below, the OXY channel failed calibration. The other sensors calibrated normally.

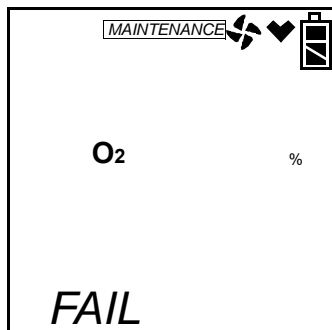

The buzzer and alarm lights activate. Press and release the RESET SILENCE button after the buzzer and lights stop to reset the alarm and return to the calibration menu. Attempt to calibrate again. If the failure continues, investigate the cause. See “Troubleshooting” on page 170.

16. Disconnect the tubing from the probe.
17. Unscrew the demand flow regulator from the calibration cylinder.
18. If you have a 5 sensor unit and wish to calibrate the %volume sensor, go back to step 1 and repeat the process selecting the %volume calibration gas value screen in step 12 and using a %volume methane cylinder.

If you are finished calibrating, use the (SHIFT)▼ button to navigate to the **NORMAL** menu item, then press and release the POWER ENTER button to return to Measuring Mode.

Calibrating with the Single Calibration Method

This section describes calibration using the Single Calibration method. To calibrate using the Auto Calibration method, see “Calibrating with the Auto Calibration Method” on page 64.

The procedure below describes a span adjustment of one channel using a calibration kit that includes a 3-gas calibration cylinder, a 0.5 LPM (liters per minute) regulator, and non-absorbent sample tubing. The standard 3-gas cylinder consists of 50% LEL methane, 12% oxygen, 50 ppm CO, and a balance of nitrogen. In the example below, the CH₄ channel’s span is adjusted. See “Parts List” on page 186 for available calibration kits and calibration kit spare parts.

Calibration cylinders that contain only one target gas may also be used for single calibration. For channels other than oxygen, RKI Instruments, Inc. recommends that you use a cylinder that contains a

concentration of 10-50% of the full scale value of the target gas. For example, if you are calibrating the combustible gas channel, your calibration cylinder should have a combustible gas concentration between 10% LEL and 50% LEL. For the oxygen channel, RKI Instruments, Inc. recommends using 100% nitrogen to perform the adjustment but any concentration between 0% oxygen (100% nitrogen) and 17% oxygen can be used to make the adjustment.

NOTE: If your combustible gas channel is calibrated to a gas other than methane, use an appropriate gas cylinder to perform the calibration.

CAUTION: *The single calibration method does not have a “FAIL” notification. If a sensor cannot be set to agree with the calibration source, see “Troubleshooting” on page 170.*

1. While in the calibration menu, use the AIR▲ or (SHIFT) ▼ button to navigate to the ONE CAL menu option.

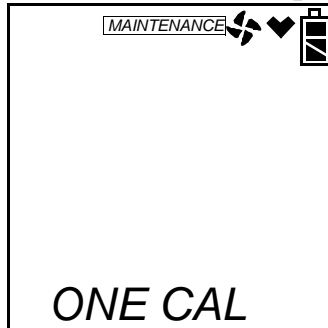

2. Press and release the POWER ENTER button to display the single calibration menu. The %LEL sensor will be displayed first.

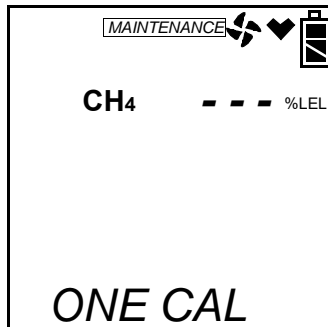

3. Use the AIR▲ or (SHIFT)▼ button to display the sensor you want to calibrate (in this example the combustible gas % LEL sensor). If you have a 5 sensor unit, the %vol sensor will be one of the choices. It is shown below.

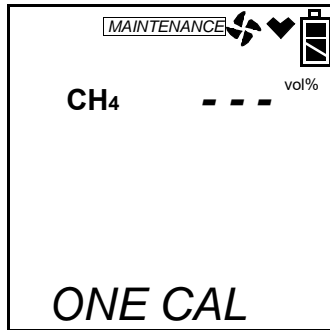

4. Press and release the POWER ENTER button. The single calibration screen displays for the sensor you selected. The gas reading flashes.

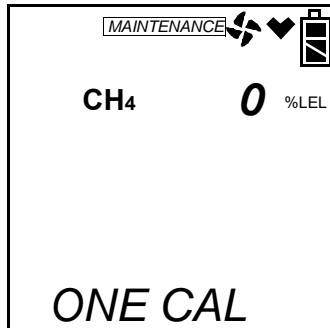

5. Connect the tubing from the demand flow regulator to the rigid tube on the probe. Allow the calibration gas to flow for one minute.
6. If necessary, use the AIR▲ and (SHIFT)▼ buttons to adjust the reading to match the concentration listed on the calibration cylinder.

If the reading already matches the concentration listed on the calibration cylinder, press and release the AIR▲ button then press and release the (SHIFT)▼ button so that the instrument sees a change and resets the calibration date.

7. Press and release the POWER ENTER button to save the span value. The LCD will indicate that the calibration has ended, then the single calibration menu displays.

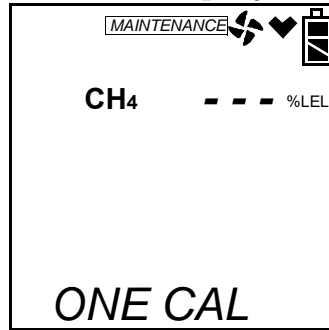

8. Disconnect the tubing from the Gas Tracer's probe.
9. Repeat steps 3 through 8 for any other sensors you want to calibrate. Make sure you use an appropriate calibration cylinder for each sensor.

CAUTION: *When calibrating the oxygen channel, verify the concentration of oxygen listed on the cylinder's label. For oxygen-free samples (100% nitrogen for example), set the oxygen zero setting to 0.0%.*

10. After the last channel is calibrated, disconnect the calibration tubing from the probe, then unscrew the demand flow regulator from the calibration cylinder.
11. Use the AIR▲ and (SHIFT)▼ buttons to scroll to ESCAPE in the ONE CAL menu.
12. Press and release the POWER ENTER button to exit ONE CAL.
13. With the ONE CAL menu option displayed, press the (SHIFT)▼ button until the NORMAL menu option is displayed.
14. Press and release the POWER ENTER button to return to Measuring Mode.

Bump Testing the Gas Tracer

NOTE: The **BUMP DSP** menu item in Maintenance Mode is factory set to OFF. The **BUMP** menu item will not appear unless **BUMP DSP** is set to ON. See “Turning the Bump Test Function On or Off” on page 151 for instructions.

NOTE: The Gas Tracer uses parameters defined in the **BUMP--SET** menu item of Maintenance Mode while performing a bump test. To view or update these parameters, see “Updating the Bump Test Parameters” on page 152.

NOTE: If the combustible gas channels are calibrated to a gas other than methane, use an appropriate multigas cylinder.

From Measuring Mode, enter Calibration Mode by pressing and holding the (SHIFT)▼ button, then pressing the DISPLAY(ADJ) button and releasing both. If the unit prompts you for the password, enter it by using the AIR▲ and (SHIFT)▼ buttons to select each password number and then pressing and releasing POWER ENTER to confirm it and move on to the next number. To go back a number, press and release the RESET SILENCE button. The factory set password is the same as the factory set password for Maintenance Mode: 2102. You can change the password by entering the **PASSWORD** menu item in Maintenance Mode. See “Turning the Password Function On or Off” on page 167. If you enter an incorrect password, an error screen will display.

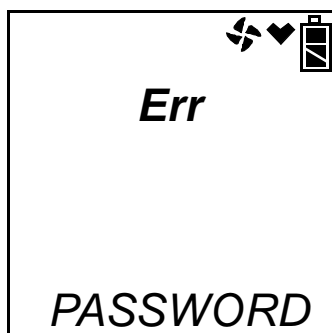

To return to normal operation, press and release the RESET SILENCE button. You may then try to reenter Calibration Mode.

MAINTENANCE will appear along the top of the screen once you have entered Calibration Mode. The first item in the calibration menu, AIR CAL, displays.

1. Install the demand flow regulator onto the calibration cylinder.
2. Connect the sample tubing to the demand flow regulator.

3. Install the hose and probe to the Gas Tracer.
4. Use the AIR▲ or (SHIFT)▼ buttons to display the BUMP menu item.

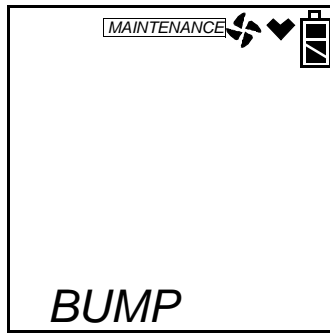

5. Press and release the POWER ENTER button to display the bump test gas values.

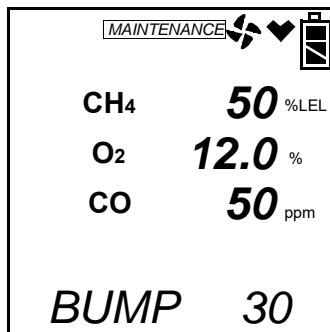

6. Use the AIR▲ or (SHIFT)▼ buttons to see the %volume combustible gas bump test value.

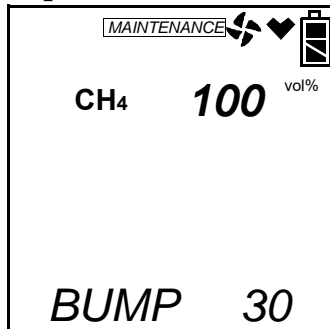

7. A bump test may be performed on the standard 3 sensors or on the %volume combustible sensor. Use the AIR▲ or (SHIFT)▼ buttons to display the screen of sensor(s) you wish to bump test.
8. Before proceeding, confirm that the bump test gas value(s) are the same as the concentration(s) in the calibration cylinder. If they are not, adjust the bump test gas value(s) by entering the AUTO CAL menu item, changing the values there, and reentering the BUMP menu.
9. Connect the tubing from the demand flow regulator to the rigid tube on the probe then quickly press and release the POWER

ENTER button. The unit will begin counting down from 30.

10. When AUTO CAL in the **BUMP--SET** menu item in Maintenance Mode is set to OFF:

- The instrument will display which channels passed or failed the bump test with a P (pass) or an F (fail) to the right of the gas.

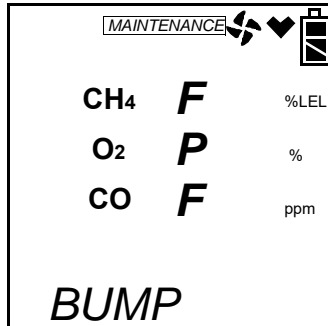

- To view the bump test gas readings press the AIR▲ or (SHIFT)▼ button. You can scroll between the bump test results and the bump test gas readings with the AIR▲ or (SHIFT)▼ button.

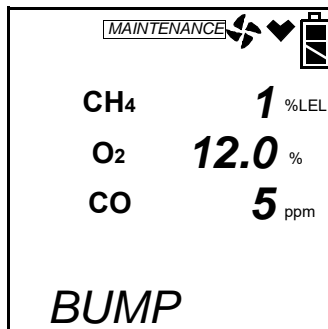

- To return to the BUMP screen in Calibration Mode, press POWER ENTER.

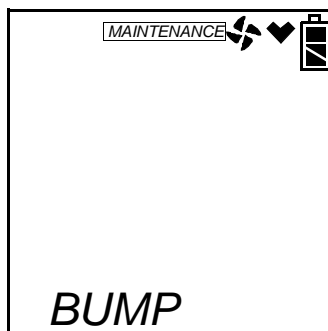

If one or more sensors fail the bump test, see “Troubleshooting” on page 170 to investigate the cause of the failure and replace the failed sensor or sensors if necessary.

- Disconnect the tubing from the probe.

11. When AUTO CAL in the **BUMP--SET** menu item in Maintenance Mode is set to ON:

If all channels pass the bump test,

- The following screen appears:

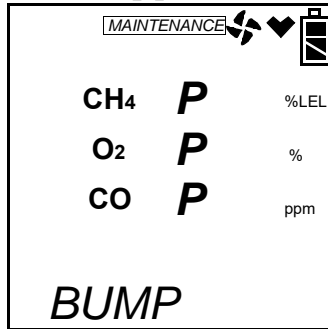

- To view the bump test gas readings press the AIR▲ or (SHIFT)▼ button. You can scroll between the bump test results and the bump test gas readings with the AIR▲ or (SHIFT)▼ button.

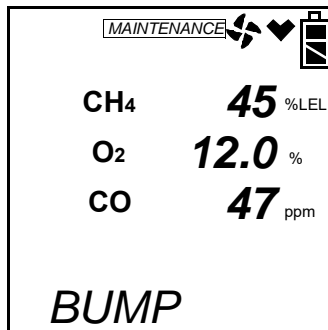

- To return to the BUMP screen in Calibration Mode, press POWER ENTER.

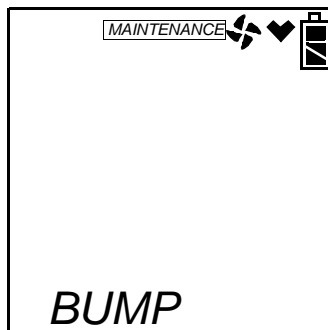

- Disconnect the tubing from the probe.

If any channel fails the bump test,

- The instrument will beep and a calibration is immediately and automatically started. Continue to apply the calibration gas. CAL on the bottom left of the screen will alternate with APPLY.

The calibration time will begin to countdown in seconds in the

lower right of the screen. The calibration time counted down during a calibration initiated because of a failed bump test is the difference between the bump test gas time and the calibration time defined in the **BUMP--SET** menu item in Maintenance Mode.

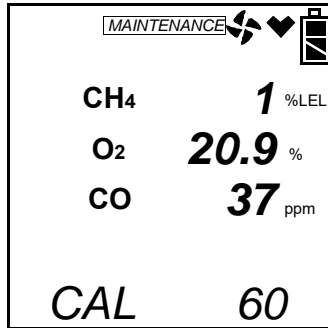

- At the end of the calibration, the instrument displays the results from both the bump test and the calibration. Use the AIR▲ or (SHIFT)▼ buttons to scroll between the calibration/ bump test results, the bump test gas readings, and the calibration gas readings.

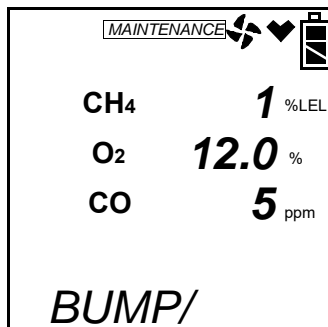
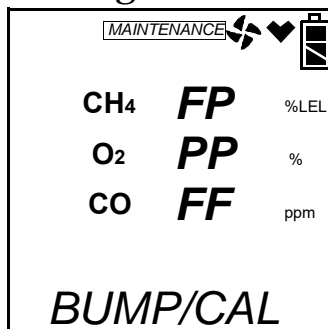

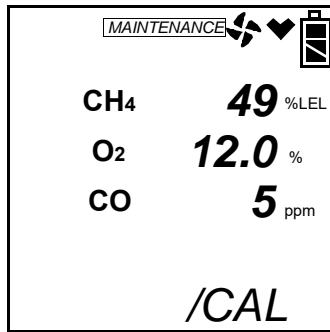

- To return to the **BUMP** screen in Calibration Mode, press **POWER ENTER** at any time. If any channel failed the calibration, the buzzer will sound a double pulsing tone until you press and release the **POWER ENTER** button.

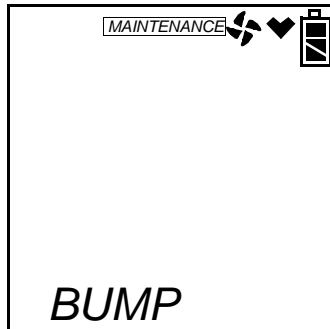

- Disconnect the tubing from the probe.
- Unscrew the demand flow regulator from the calibration cylinder.
 - With the **BUMP** menu option displayed, press the (SHIFT)▼ button until the **NORMAL** menu option is displayed.
 - Press and release the **POWER ENTER** button to return to Measuring Mode.

Calibrating and Bump Testing the PPM Combustible Sensor

The PPM sensor in the Gas Tracer needs to be calibrated and bump tested separately. It cannot be calibrated using the **AUTO CAL** or **ONE CAL** menu items in the main menu or bump tested using the **BUMP** menu item in the main menu. The **PPM CAL** menu item must be used. In addition, a 6 inch humidifier tube must be used to connect the ppm calibration cylinder to the instrument.

From Measuring Mode, enter Calibration Mode by pressing and holding the (SHIFT)▼ button, then pressing the **DISPLAY(ADJ)** button and releasing both. If the unit prompts you for the password, enter it by using the **AIR▲** and (SHIFT)▼ buttons to select each password number and then pressing and releasing **POWER ENTER** to

confirm it and move on to the next number. To go back a number, press and release the RESET SILENCE button. The factory set password is the same as the factory set password for Maintenance Mode: 2102. You can change the password by entering the **PASSWORD** menu item in Maintenance Mode. See “Turning the Password Function On or Off” on page 167. If you enter an incorrect password, an error screen will display.

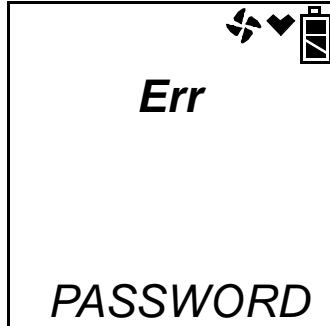

To return to normal operation, press and release the RESET SILENCE button. You may then try to reenter Calibration Mode.

MAINTENANCE will appear along the top of the screen once you have entered Calibration Mode. The first item in the calibration menu, AIR CAL, displays.

1. Use the AIR▲ or (SHIFT)▼ buttons to display the **PPM CAL** menu item.

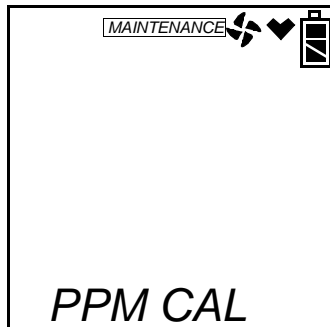

2. Press and release the POWER ENTER button. The display will indicate that the ppm sensor is warming up.

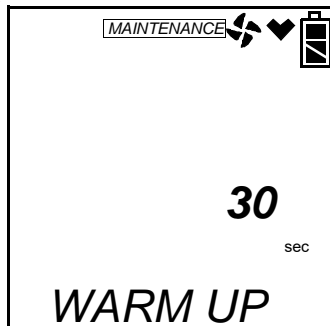

Performing a PPM Fresh Air Adjustment

This section describes how to perform a fresh air adjustment on the PPM combustible gas sensor.

1. Once the warm up is complete, you will be in PPM Cal Mode and AIR CAL will be displayed. You must perform a fresh air adjust before performing an auto calibration, a single calibration, or a bump test.

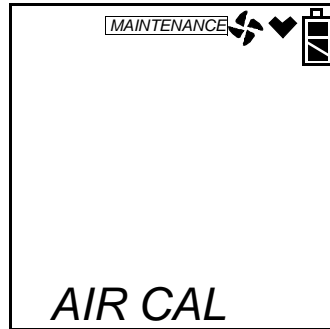

2. Be sure the Gas Tracer is in a fresh air environment.
3. Press and release the POWER ENTER button to enter the AIR CAL menu item. The unit will display the current fresh air reading and prompt you to push the AIR▲ button.

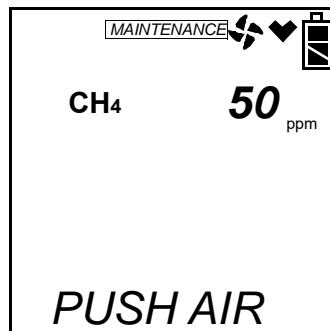

4. Allow the instrument to draw fresh air for 2 minutes.
5. Hold down the AIR▲ button. The unit will prompt you to continue holding the AIR▲ button.

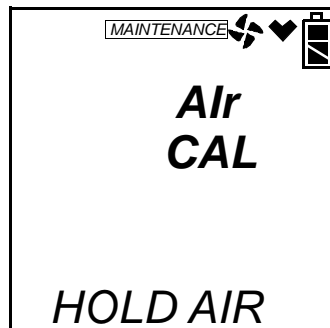

6. When the unit prompts you to release the AIR▲ button, release it. The instrument will perform a fresh air adjustment on the ppm sensor and return you to the AIR CAL menu item.

Performing a PPM AUTO CAL

This section describes how to calibrate the PPM combustible gas sensor using auto calibration.

1. Install the demand flow regulator onto the calibration cylinder.
2. Connect the humidifier to the demand flow regulator.
3. Install the hose and probe to the Gas Tracer.
4. To calibrate the ppm sensor using auto calibration, use the AIR▲ button to scroll to AUTO CAL.
5. Press and release the POWER ENTER button. The calibration value screen will be displayed. If you want to exit back to the main menu without completing a calibration, press and release the DISPLAY (ADJ) button.

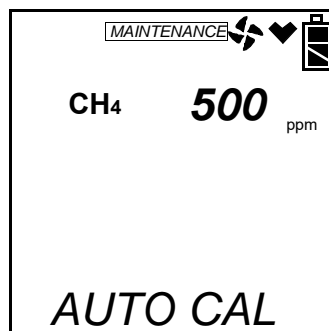

6. The gas concentration displayed in the calibration value screen must match the gas concentration listed on the calibration cylinder. If the concentration matches, go to step 12. If the concentration does not match, continue with step 7.
7. To adjust the value on the screen, hold down the (SHIFT)▼ button, then press the DISPLAY(ADJ) button and release both. The calibration gas value turns into three dashes.

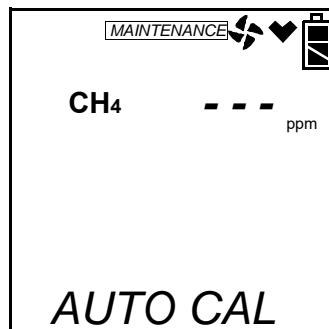

8. Press and release the POWER ENTER button. The sensor's calibration gas value will flash.
9. If necessary, use the AIR▲ and (SHIFT)▼ buttons to set the correct calibration gas value.

10. Press and release the POWER ENTER button to save the change.
11. Use the AIR▲ or (SHIFT)▼ buttons to scroll to ESCAPE and press and release POWER ENTER to return to the calibration gas value screen.
12. With the calibration gas value screen displayed, press the POWER ENTER button. AUTO CAL begins to flash and the current gas reading is displayed. If you want to exit back to the main menu without completing a calibration, press and release the DISPLAY (ADJ) button.

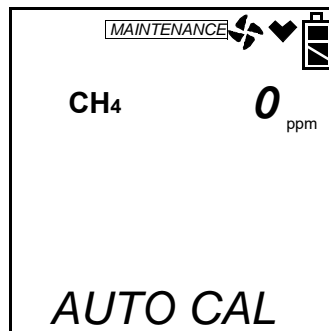

13. Connect the humidifier from the demand flow regulator to the rigid tube on the probe. Allow the gas to flow for two minutes.
14. Press and release the POWER ENTER button to set the calibration to the programmed values.

If the ppm sensor passed calibration, PASS displays along the bottom of the screen, then the AUTO CAL menu item displays.

If the ppm sensor cannot calibrate to the proper value, FAIL displays along the bottom of the screen and the Gas Tracer indicates that the ppm sensor failed to calibrate.

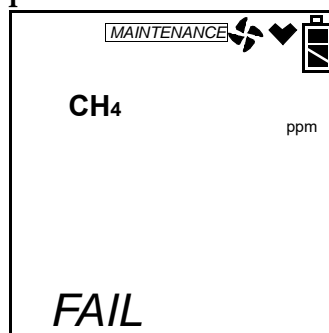

The buzzer and alarm lights activate. Press and release the RESET SILENCE button after the buzzer and lights stop to reset the alarm and return to the AUTO CAL menu item. Attempt to calibrate again. If the failure continues, investigate the cause. See “Troubleshooting” on page 170.

15. Disconnect the humidifier from the probe.

NOTE: Grasp the humidifier tube assembly by the clear tubing at the end, not the humidifier tube itself.

16. Unscrew the demand flow regulator from the calibration cylinder.
17. Use the (SHIFT)▼ button to navigate to the ESCAPE menu item, then press and release the POWER ENTER button to return to the **PPM CAL** menu item in Calibration Mode.
18. Use the (SHIFT)▼ button to navigate to the **NORMAL** menu item, then press and release the POWER ENTER button to return to Measuring Mode.

Performing a PPM Single Calibration

This section describes how to calibrate the PPM combustible gas sensor using single calibration.

1. Install the demand flow regulator onto the calibration cylinder.
2. Connect the humidifier to the demand flow regulator.
3. Install the hose and probe to the Gas Tracer.
4. To calibrate the ppm sensor using single calibration, use the AIR▲ button to scroll to ONE CAL.
5. Press and release the POWER ENTER button. The gas reading will be replaced by 3 dashes.

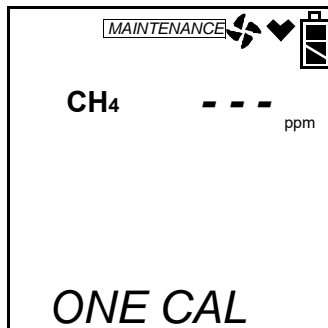

6. Press and release the POWER ENTER button. The single calibration screen displays. The gas reading flashes.

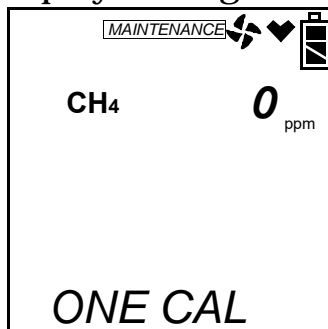

7. Connect the humidifier from the demand flow regulator to the rigid tube on the probe. Allow the calibration gas to flow for two minutes.
8. If necessary, use the AIR▲ and (SHIFT)▼ buttons to adjust the reading to match the concentration listed on the calibration cylinder.

If the reading already matches the concentration listed on the calibration cylinder, press and release the AIR▲ button then press and release the (SHIFT)▼ button so that the instrument sees a change and resets the calibration date.

9. Press and release the POWER ENTER button to save the span value. The LCD will indicate that the calibration has ended, then the **ONE CAL** menu item displays.
10. Disconnect the humidifier from the probe.

NOTE: Grasp the humidifier tube assembly by the clear tubing at the end, not the humidifier tube itself.

11. Unscrew the demand flow regulator from the calibration cylinder.
12. Use the (SHIFT)▼ button to navigate to the **ESCAPE** menu item, then press and release the POWER ENTER button to return to the **PPM CAL** menu in Calibration Mode.
13. Use the (SHIFT)▼ button to navigate to the **NORMAL** menu item, then press and release the POWER ENTER button to return to Measuring Mode.

Performing a PPM Bump Test

NOTE: The **BUMP DSP** menu item in Maintenance Mode is factory set to OFF. The **BUMP** menu item will not appear unless **BUMP DSP** is set to ON. See “Turning the Bump Test Function On or Off” on page 151 for instructions.

NOTE: The Gas Tracer uses parameters defined in the **BUMP--SET** menu item of Maintenance Mode while performing a bump test. To view or update these parameters, see “Updating the Bump Test Parameters” on page 152.

1. Install the demand flow regulator onto the calibration cylinder.
2. Connect the humidifier to the demand flow regulator.
3. Install the hose and probe to the Gas Tracer.

4. While in the **PPM CAL** menu, use the AIR▲ or (SHIFT)▼ buttons to display the **BUMP** menu item.

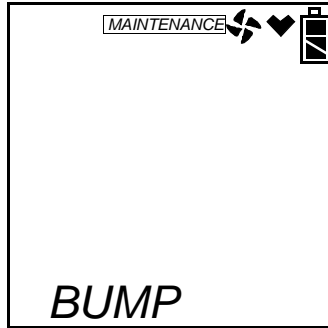

5. Press and release the POWER ENTER button. The bump test gas value screen will be displayed.

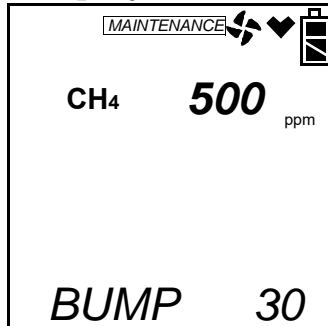

6. Before proceeding, confirm that the bump test gas value is the same as the concentration in the calibration cylinder. If it is not, adjust the bump test gas value by entering the **AUTO CAL** menu item in the **PPM CAL** menu, changing the value there, and reentering the **BUMP** menu.
7. Connect the humidifier from the demand flow regulator to the rigid tube on the probe then quickly press and release the **POWER ENTER** button. The unit will begin counting down from 30.
8. When **AUTO CAL** in the **BUMP--SET** menu item in Maintenance Mode is set to **OFF**:
 - The instrument will display if the ppm combustible sensor passed or failed with a **P** (pass) or an **F** (fail) to the right of the gas.

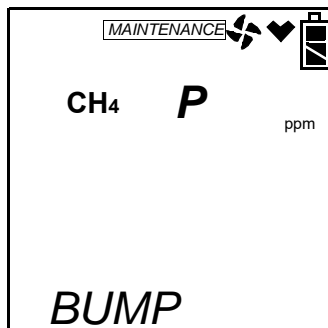

- To view the bump test gas reading press the AIR▲ or (SHIFT)▼ button. You can scroll between the bump test results and the bump test gas reading with the AIR▲ or (SHIFT)▼ button.

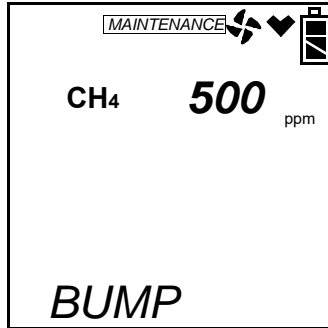

- To return to the BUMP screen in PPM CAL, press POWER ENTER.

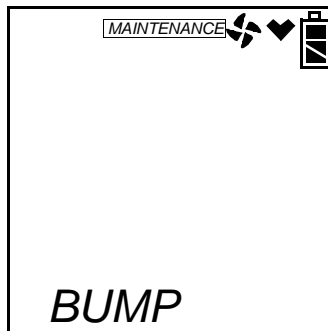

If the sensor fails the bump test, see “Troubleshooting” on page 170 to investigate the cause of the failure and replace the failed sensor if necessary.

- Disconnect the humidifier from the probe.

NOTE: Grasp the humidifier tube assembly by the clear tubing at the end, not the humidifier tube itself.

9. When AUTO CAL in the **BUMP--SET** menu item in Maintenance Mode is set to ON:

If the ppm combustible sensor passes the bump test,

- The following screen appears:

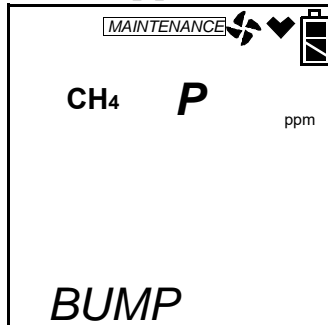

- To view the bump test gas reading press the AIR▲ or (SHIFT)▼ button. You can scroll between the bump test results and the bump test gas reading with the AIR▲ or (SHIFT)▼ button.

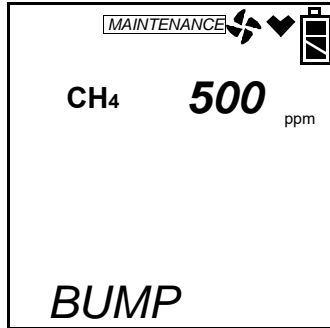

- To return to the BUMP screen in PPM CAL, press POWER ENTER.

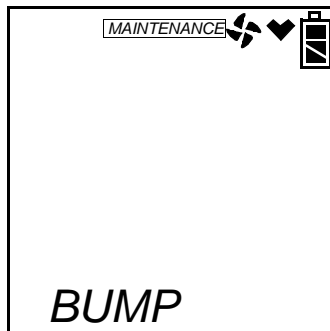

- Disconnect the humidifier from the probe.

NOTE: Grasp the humidifier tube assembly by the clear tubing at the end, not the humidifier tube itself.

If the ppm combustible sensor fails the bump test,

- The instrument will beep and a calibration is immediately and automatically started. Continue to apply the calibration gas. CAL on the bottom left of the screen will alternate with APPLY.

The calibration time will begin to countdown in seconds in the lower right of the screen. The calibration time counted down during a calibration initiated because of a failed bump test is the difference between the bump test gas time and the calibration time defined in the **BUMP--SET** menu item in Maintenance Mode.

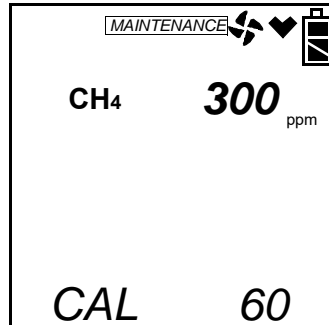

- At the end of the calibration, the instrument displays the results from both the bump test and the calibration. Use the AIR▲ or (SHIFT)▼ button to scroll between the calibration/bump test results, the bump test gas reading, and the calibration gas reading.

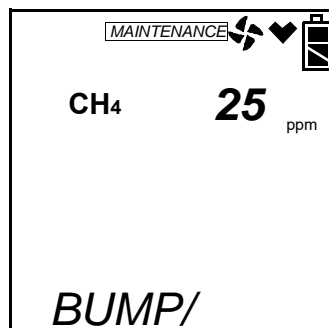
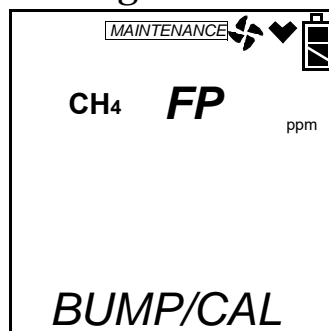

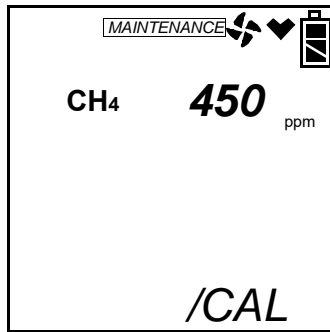

- To return to the BUMP screen in **PPM CAL**, press **POWER ENTER** at any time. If the sensor fails calibration, the buzzer will sound a double pulsing tone until you press and release the **POWER ENTER** button.

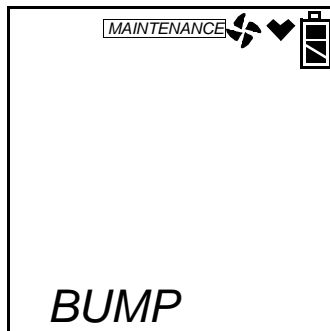

- Disconnect the humidifier from the probe.

NOTE: Grasp the humidifier tube assembly by the clear tubing at the end, not the humidifier tube itself.

10. Unscrew the demand flow regulator from the calibration cylinder.
11. Use the (SHIFT)▼ button to navigate to the **ESCAPE** menu item, then press and release the **POWER ENTER** button to return to the **PPM CAL** menu item in Calibration Mode.
12. Use the (SHIFT)▼ button to navigate to the **NORMAL** menu item, then press and release the **POWER ENTER** button to return to Measuring Mode.

Chapter 4: Using the Gas Tracer in Bar Hole Mode

Overview

This chapter explains how to operate the Gas Tracer in Bar Hole Mode. Bar Hole Mode is used to perform consistent checks of bar holes when tracking down underground gas leaks. When the Gas Tracer is in Bar Hole Mode, only the combustible and oxygen channels are displayed.

If a Gas Tracer is intended for bar hole testing, it is shipped with Bar Hole Mode enabled so that the operator must choose which operational mode to use when the unit is turned on.

NOTE: Units intended for bar hole testing are typically calibrated to methane. In addition, the unit must have a %volume combustible sensor installed.

Start Up, Bar Hole Mode

This section explains how to start up the Gas Tracer in Bar Hole Mode and get it ready for operation.

Turning On the Gas Tracer, Bar Hole Mode

WARNING: If a CO sensor is installed, this sensor will not be active while the Gas Tracer is in Bar Hole Mode.

WARNING: Gas alarms are not active when the Gas Tracer is in Bar Hole Mode.

The following description of the Gas Tracer start up sequence assumes that the following menu items in Maintenance Mode are turned on: **LNCH BRK**, **ID DISP**, **CL RMNDR**, and **BP RMNDR**. If either of these items is turned off, then the corresponding screen will not appear.

NOTE: In order for **BAR HOLE MODE** to appear as a selection in the Mode Select Screen, the **L./B. MODE** item in Maintenance Mode must be set to bH or LC bH.

1. Connect the sample hose to the Gas Tracer's quick connect inlet fitting.

2. Screw the bar hole probe onto the sample hose's threaded fitting.
3. Press and briefly hold down the POWER ENTER button. The Normal Mode Select Screen displays.

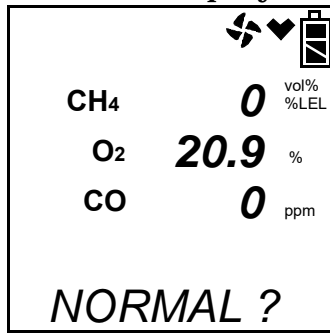

4. Use the AIR▲ or (SHIFT)▼ buttons to scroll to the Bar Hole Mode Select Screen.

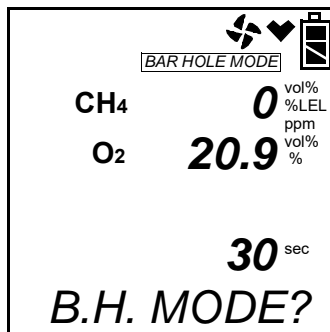

5. With the Bar Hole Mode Select Screen selected, press and release the POWER ENTER button to begin the Bar Hole Mode startup sequence.

NOTE: If no button is pressed for 20 seconds, the unit will proceed into whichever mode is displayed.

6. If **CL RMNDR** is turned on (factory setting), the screen that appears next depends on how **CL EXPRD** is set in the Maintenance Mode Menu (page 156).
 - If the unit is due for calibration and **CL EXPRD** is set to CONFIRM (factory setting), then the following screen displays.

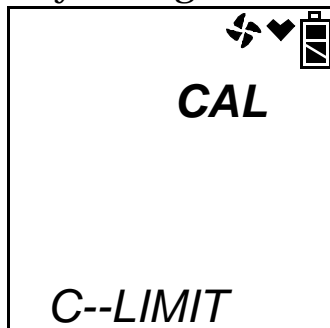

The alarm LED's and buzzer will pulse several times. After this, press and release the RESET SILENCE button to continue.

- If the unit is due for calibration and **CL EXPRD** is set to NOT USE, then the following screen displays.

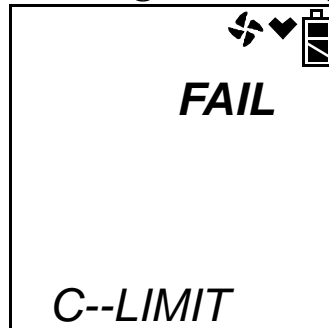

The Gas Tracer cannot be used until a calibration has been performed either by selecting **AUTO CAL** or **ONE CAL** in the Maintenance Mode menu. See “Calibrating Using Auto Calibration” on page 120 or “Calibrating Using Single Calibration” on page 123 for calibration instructions.

- If calibration is not due or **CL EXPRD** is set to NO EFFECT, then the following screen appears for a few seconds indicating when the next calibration is due.

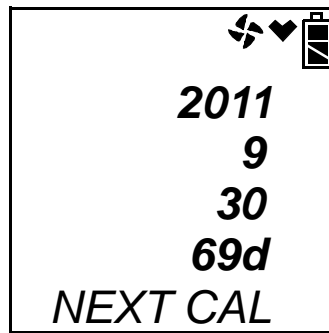

7. If **BP RMNDR** is turned on (factory setting is OFF), the screen that appears next depends on how **BP EXPRD** is set in the Maintenance Mode Menu (page 156).

- If the unit is due for a bump test and **BP EXPRD** is set to CONFIRM (factory setting), then the following screen displays.

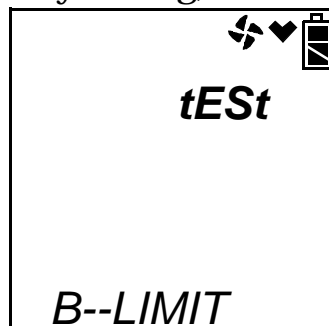

The alarm LED's and buzzer will pulse several times. After this, press the RESET SILENCE button until you hear a beep to continue.

- If the unit is due for a bump test and **BP EXPRD** is set to NOT USE, then the following screen displays.

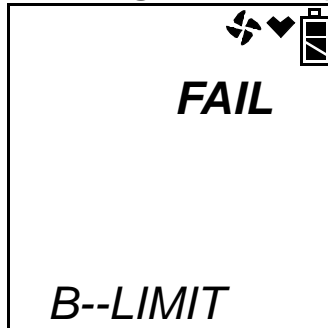

The Gas Tracer cannot be used until a bump test has been performed by selecting **BUMP** in the Maintenance Mode menu. See “Performing a Bump Test” on page 126 for bump testing instructions.

- If a bump test is not due or **BP EXPRD** is set to NO EFFECT, then the following screen appears for a few seconds indicating when the next bump test is due.

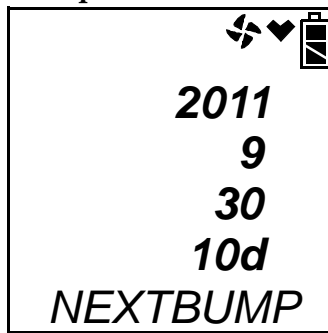

NOTE: If both **CL RMNDR** and **BP RMNDR** are turned off, a WARM UP screen will display before the warm up sequence continues.

8. If **ID DISP** is turned on (see page 161), the User ID Screen displays for a few seconds and then the Station ID Screen displays for a few seconds.

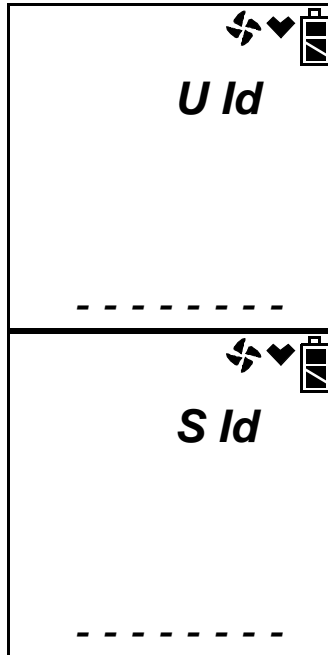

9. The Date/Time Screen appears for a few seconds.

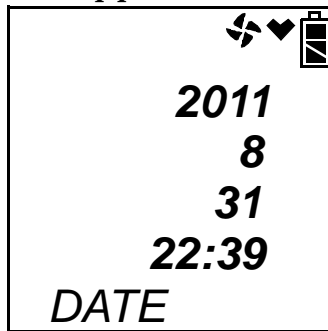

This screen displays the current year, month, day, and time.

10. The Battery Level and Alarm Pattern Screen appears next.

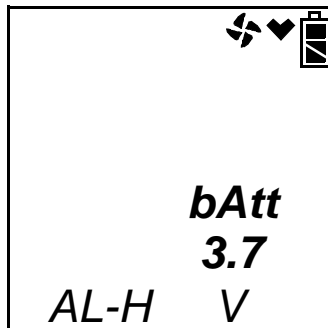

AL -- H indicates latching (hold) alarms and AL -- A indicates self-resetting (automatic) alarms. The number shown indicates the voltage of the batteries. If the unit is powered by alkaline (dry cell) batteries, a "D" will appear in front of the "V" in the lower right

corner.

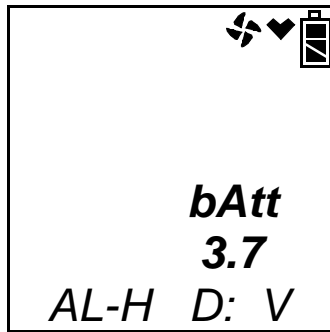

11. The display then indicates the following items for about a second each:

- Full scale values for all channels
- Warning setpoint (low gas alarm) for all channels
- Alarm setpoint (high gas alarm) for all channels
- STEL alarm setpoint for the CO channel
- TWA alarm setpoint for the CO channel

12. If the Gas Tracer experiences a sensor failure during start up, a screen indicating which sensor failed displays. In the example below, the combustible gas %volume sensor has failed.

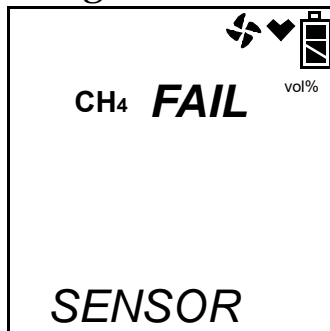

If one of the combustible sensors, LEL or % volume, fails, it is not possible to enter Bar Hole Mode. Press and release the RESET SILENCE button to acknowledge the failure and return to the Mode Select Screen. Replace the failed sensor as soon as possible.

If the oxygen sensor fails, press and release the RESET SILENCE button to acknowledge the failure and continue to Bar Hole Mode. The gas reading for the oxygen sensor will be replaced by “XXX”. Replace the failed sensor as soon as possible.

If the CO sensor is installed and fails, press and release the RESET SILENCE button to acknowledge the failure and continue to Bar Hole Mode.

13. The Gas Tracer is now operating in Bar Hole Mode. The pump is off and the following screen appears.

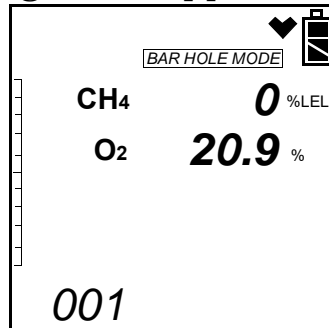

The methane and oxygen channels are displayed along with the battery charge level.

Performing a Fresh Air Adjustment, Bar Hole Mode

Before using the Gas Tracer, it is recommended to set the fresh air readings for the target gases by performing a fresh air adjustment. This will set the combustible gas channel to zero and the OXY channel to 20.9%.

1. Find a fresh-air environment. This is an environment free of toxic or combustible gases and of normal oxygen content (20.9%).
2. Turn on the unit as described above in “Turning On the Gas Tracer, Bar Hole Mode”.
3. Press and hold the AIR▲ button. The pump will start and the display will prompt you to hold the AIR▲ button.
4. Continue to hold the AIR▲ button until the display prompts you to release the AIR▲ button. The Gas Tracer will set the fresh air reading for the CH₄ and oxygen channels as it counts down from 8. Once the countdown has finished, start up is complete and the unit is ready for bar hole testing.

Bar Hole Testing

In Bar Hole Mode, you can initiate sampling for a fixed time period to monitor for methane and oxygen in a bar hole. The factory set time is 30 seconds. To change the bar hole sampling time, see “Updating the Bar Hole Sampling Time” on page 165. At the end of the sample period, the pump will shut off and the peak methane and minimum oxygen levels monitored during the sample period will be displayed. Bar Hole Mode also allows you to initiate an air purge cycle to purge gas from the Gas Tracer after a sample is taken.

In a low-light environment, press and release the (SHIFT)▼ button to turn on the display backlight. Although the backlight will turn on when any button is pressed, other buttons may initiate an undesired operation sequence. See “Updating the LCD Back Light Time Setting” on page 161 to program backlight duration. If **BEEP. SET** is turned on in the Maintenance Mode menu, the Gas Tracer beeps once every 5 minutes to confirm that it’s operating.

While in Bar Hole Mode, you may select or change the current station ID by pressing the (SHIFT)▼ button and DISPLAY (ADJ) button and releasing when you hear a beep.

Performing a Bar Hole Test

1. Start up the Gas Tracer as described in “Start Up, Bar Hole Mode” on page 88.
2. If you wish to change the station ID, press the (SHIFT)▼ and DISPLAY (ADJ) buttons and release when you hear a beep. The current station ID will be displayed and it will be flashing. If you wish to exit the Station ID Select Screen without making any change, press and release the RESET SILENCE button.

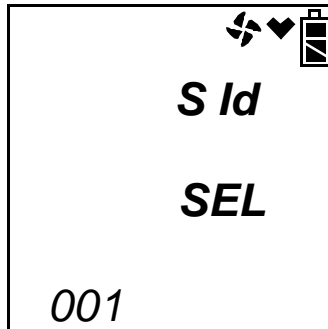

Use the AIR▲ and (SHIFT)▼ buttons to scroll to the desired station ID and press and release POWER ENTER. The unit will return to the Bar Hole Measuring Screen.

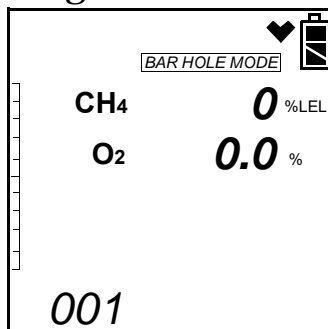

3. Take the Gas Tracer to the bar hole that will be tested.
4. Insert the probe into the bar hole and press and release the POWER ENTER button. The pump will turn on and the sample period will

begin with the sample period counting down in seconds in the lower right corner of the display. The CH₄ channel will be displayed in %VOL. The methane channel's reading will also be displayed in graph format on the left side of the screen. If you wish to cancel the measurement, press and release the RESET SILENCE button.

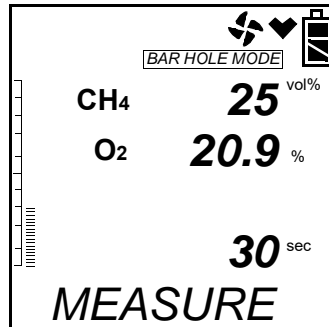

5. After 15 seconds of sampling, if the combustible gas reading is less than 5 %VOL, the combustible gas channel will automatically begin displaying in %LEL.
6. At the end of the sample period, the pump will shut off and the buzzer will sound, then the peak methane reading and the minimum oxygen reading for the sample period will be displayed. The peak methane reading will also be visually displayed on the graph along the left side of the screen.

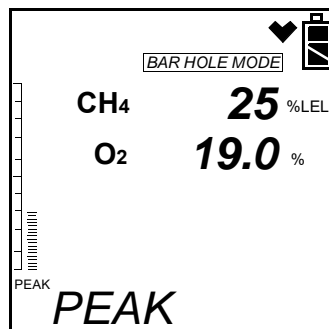

7. If a high concentration of methane is encountered, a fresh air purge can be performed to purge the hose, probe and Gas Tracer of gas before the next bar hole test. To perform a purge, do the following:
 - Remove the probe from the barhole so the instrument will draw fresh air.

- Press and release the DISPLAY (ADJ) button. The display will now indicate PURGE along the bottom of the screen and the purge time will begin counting down from 30 seconds in the lower right corner of the display. If you wish to cancel the purge, press and release the RESET SILENCE button.

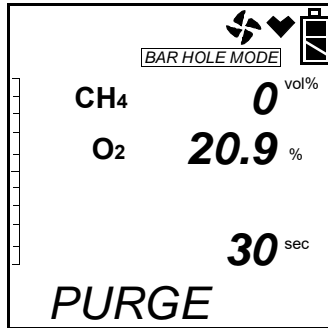

- When the purge is complete, the screen will return to the initial Bar Hole Mode screen.

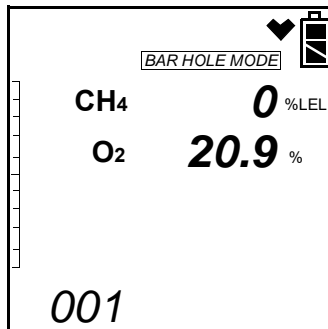

8. If other bar holes will be tested, proceed to the next bar hole and repeat steps 4 - 7.
9. To cancel a bar hole measurement or fresh air purge that is in progress, press and release the RESET SILENCE button.
10. To exit Bar Hole Mode and return to the Mode Select Screen at any time, press and hold the (SHIFT)▼ button for 5 seconds.

Turning Off the Gas Tracer, Bar Hole Mode

1. Press and hold the POWER ENTER button.
2. The unit will initiate a bar hole measurement. Keep holding the POWER ENTER button. The buzzer will pulse for about three seconds and TURN OFF will appear at the bottom of the screen.
3. Release the button when TURN OFF disappears.

Chapter 5: Using the Gas Tracer in Leak Check Mode

Overview

This chapter explains how to operate the Gas Tracer in Leak Check Mode. Leak Check Mode is used to pinpoint small leaks of combustible gas from valves, flanges, connections, and other potential leak points. When the Gas Tracer is in Leak Check Mode, only the combustible channel is displayed.

If a Gas Tracer is intended for leak check testing, it is shipped with Leak Check Mode enabled so that the operator must choose which operational mode to use when the unit is turned on (see “Turning On the Gas Tracer in Normal Mode With All Modes Active” on page 26).

Start Up, Leak Check Mode

This section explains how to start up the Gas Tracer in Leak Check Mode and get it ready for operation.

NOTE: The battery drain is higher in Leak Check Mode than in Normal Mode or Bar Hole Mode. Extended operation in this mode will result in shorter battery life than specified in “Specifications” on page 3.

Turning On the Gas Tracer, Leak Check Mode

WARNING: If an oxygen sensor is installed, it will not be active while the Gas Tracer is in Leak Check Mode.

The following description of the Gas Tracer start up sequence assumes that the following menu items in Maintenance Mode are turned on: **LNCH BRK**, **ID DISP**, **CL RMNDR**, and **BP RMNDR**. If either of these items is turned off, then the corresponding screen will not appear.

NOTE: In order for **LEAK CHECK MODE** to appear as a selection in the Mode Select Screen in Step 3 below, the **L./B. MODE** item in Maintenance Mode must be set to LC or LC bH. The factory setting is LC.

1. Connect the tapered rubber nozzle to the inlet fitting.
2. If a sample hose is used, connect the sample hose to the Gas

Tracer's quick connect inlet fitting.

NOTE: If a probe is used when using the Gas Tracer in Leak Check Mode, use the standard probe, not the bar hole probe.

3. Press and briefly hold down the POWER ENTER button. The Normal Mode Select Screen displays.

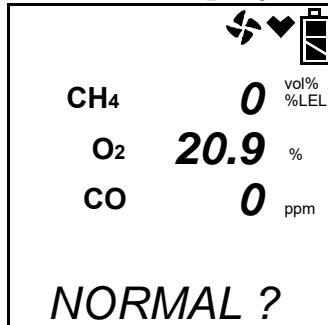

4. Use the AIR▲ or (SHIFT)▼ button to scroll to the Leak Check Mode Select Screen.

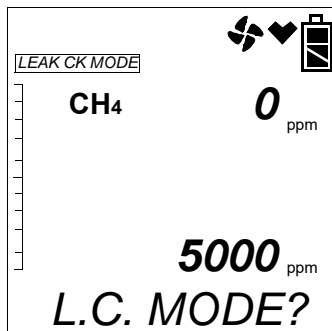

CO DISP OFF

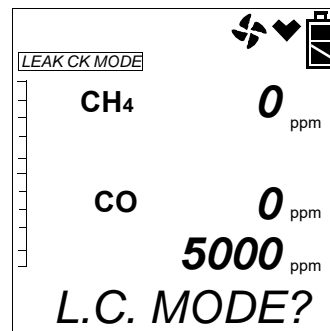

CO DISP On

NOTE: If the **CO DISP** parameter in Maintenance Mode is set to **On**, the CO channel will appear in Leak Check Mode. If the **CO DISP** parameter is set to **OFF** (factory setting), the CO channel will not appear in Leak Check Mode. All screens in this section do not show the CO channel. If **CO DISP** is turned on for your instrument, your screens may appear different.

5. With the Leak Check Mode Select Screen displayed, press and release the POWER ENTER button to begin the Leak Check Mode startup sequence.

NOTE: If no button is pressed for 20 seconds, the unit will proceed into whichever mode is displayed.

6. If **CL RMNDR** is turned on (factory setting), the screen that appears next depends on how **CL EXPRD** is set in the Maintenance Mode Menu (page 156).
- If the unit is due for calibration and **CL EXPRD** is set to **CONFIRM** (factory setting), then the following screen displays.

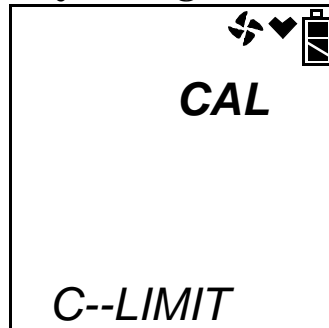

The alarm LED's and buzzer will pulse several times. After this, press and release the **RESET SILENCE** button to continue.

- If the unit is due for calibration and **CL EXPRD** is set to **NOT USE**, then the following screen displays.

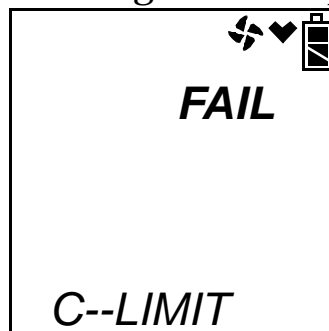

The Gas Tracer cannot be used until a calibration has been performed either by selecting **AUTO CAL**, **ONE CAL**, or **PPM CAL** in the Maintenance Mode menu. See “Calibrating Using Auto Calibration” on page 120, “Calibrating Using Single Calibration” on page 123, or “Calibrating and Bump Testing the PPM Combustible Sensor” on page 132 for calibration instructions.

- If calibration is not due or **CL EXPRD** is set to NO EFFECT, then the following screen appears for a few seconds indicating when the next calibration is due.

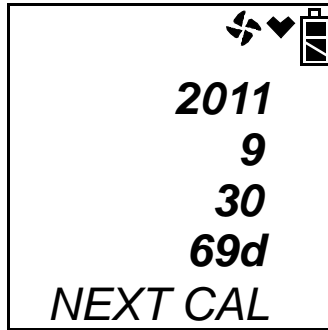

7. If **BP RMNDR** is turned on (factory setting is OFF), the screen that appears next depends on how **BP EXPRD** is set in the Maintenance Mode Menu (page 156).

- If the unit is due for a bump test and **BP EXPRD** is set to CONFIRM (factory setting), then the following screen displays.

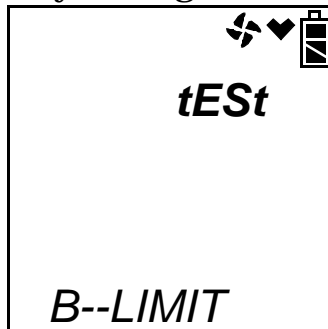

The alarm LED's and buzzer will pulse several times. After this, press the RESET SILENCE button until you hear a beep to continue.

- If the unit is due for a bump test and **BP EXPRD** is set to NOT USE, then the following screen displays.

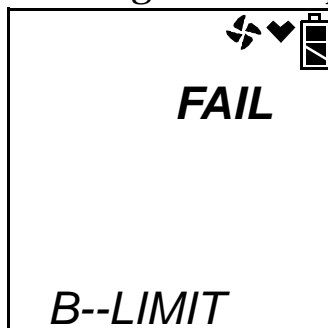

The Gas Tracer cannot be used until a bump test has been performed by selecting **BUMP** in the Maintenance Mode menu or by selecting **PPM CAL** in the Maintenance Mode menu and then selecting **BUMP**. See “Performing a Bump Test” on

page 126 for bump testing instructions.

- If a bump test is not due or **BP EXPRD** is set to NO EFFECT, then the following screen appears for a few seconds indicating when the next bump test is due.

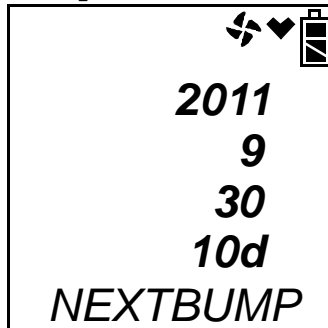

NOTE: If both **CL RMNDR** and **BP RMNDR** are turned off, a WARM UP screen will display before the warm up sequence continues.

8. If **ID DISP** is turned on (see page 161), the User ID Screen displays for a few seconds and then the Station ID Screen displays for a few seconds.

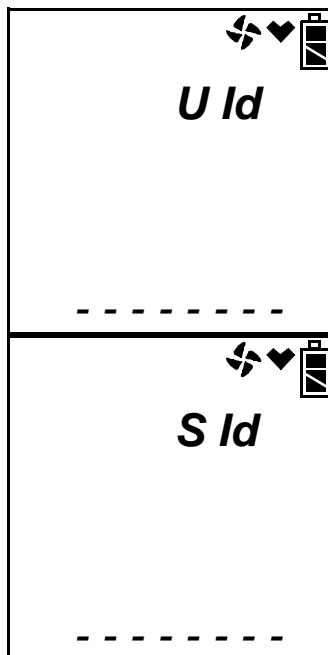

9. The Date/Time Screen appears for a few seconds.

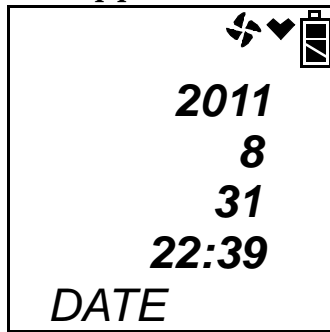

This screen displays the current year, month, date, and time.

10. The Battery Level and Alarm Pattern Screen appears next.

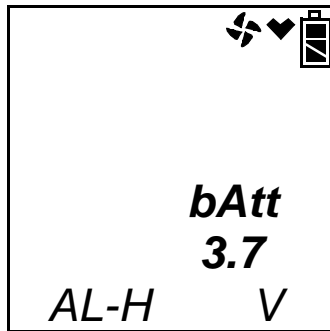

AL -- H indicates latching (hold) alarms and AL -- A indicates self-resetting (automatic) alarms. The number shown indicates the voltage of the batteries. If the unit is powered by alkaline (dry cell) batteries, a "D" will appear before the "V" in the lower right corner.

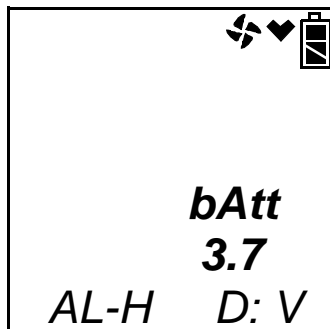

11. The display then indicates the full scale values for all channels.

12. If the Gas Tracer experiences a sensor failure during start up, a screen indicating which sensor failed displays. In the example below, the combustible gas ppm sensor has failed.

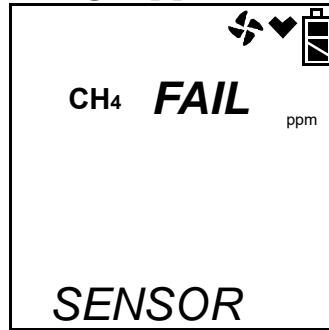

If the ppm sensor fails, it is not possible to enter Leak Check Mode. Press and release the RESET SILENCE button twice to acknowledge the failure and return to the Mode Select Screen. Replace the failed sensor as soon as possible.

If the oxygen or CO sensor is installed and fails, press and release the RESET SILENCE button to acknowledge the failure and continue to Leak Check Mode.

If an LEL or vol% sensor is installed and fails, no indication will be given and the unit will enter Leak Check Mode.

13. The Gas Tracer is now operating in Leak Check Mode.

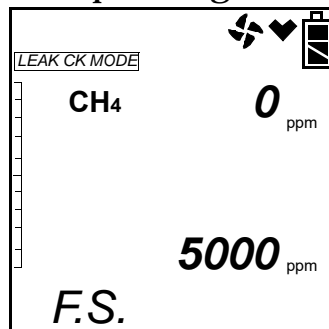

The combustible gas reading is displayed along with the battery charge level.

Performing a Fresh Air Adjustment, Leak Check Mode

Before using the Gas Tracer for leak checking, it is recommended to set the fresh air reading by performing a fresh air adjustment. This will set the combustible gas channel to zero.

1. Find a fresh-air environment. This is an environment free of toxic or combustible gases and of normal oxygen content (20.9%).
2. Turn on the unit as described above in "Turning On the Gas Tracer, Leak Check Mode" on page 98.

3. Press and hold the AIR▲ button. The display will prompt you to hold the AIR▲ button.

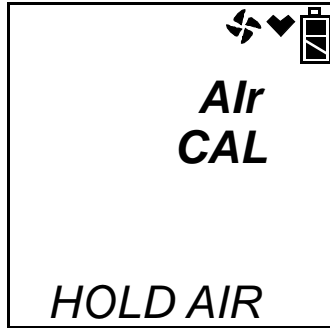

4. Continue to hold the AIR▲ button until the display prompts you to release the AIR▲ button. The Gas Tracer will set the fresh air reading for the combustibile channel. Once the fresh air adjustment has finished, start up is complete and the unit is ready for leak testing.
5. If you would like to calibrate the Gas Tracer while in Leak Check Mode, follow the same instructions described in “Calibration Mode” on page 61.

Leak Testing

In Leak Check Mode, the Gas Tracer only displays combustibile gas readings. The increment of the reading is always 10 ppm but the display range can be adjusted by using the DISPLAY (ADJ) button. The display range choices are 500 ppm, 1000 ppm, 2000 ppm, and 5000 ppm. The readings are displayed in both numerical and bar graph form. As the gas concentration increases from 0 ppm, the alarm LEDs begin to blink in unison with the buzzer’s pulsing. The blinking/pulsing rate increases as the gas reading increases. If desired the buzzer can be turned off in Leak Check Mode.

In a low-light environment, press and release any of the buttons to turn on the display backlight. See “Updating the LCD Back Light Time Setting” on page 161 to program backlight duration. If **BEEP. SET** is turned on in Maintenance Mode, the Gas Tracer beeps once every 5 minutes to confirm that it’s operating.

Setting the Display Range Value

The Gas Tracer Leak Check Mode has 4 display range ppm values to choose from: 500 ppm, 1000 ppm, 2000 ppm, and 5000 ppm.

NOTE: The Gas Tracer is always detecting combustible gas up to 5000 ppm. The display range value is only adjusting what part of the detection range is displayed on the LCD.

To change the display range value:

1. While in Leak Check Mode, press and release the DISPLAY (ADJ) button. The display range value displayed along the bottom of the screen will change.

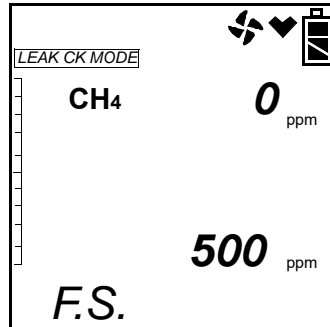

Continue to press and release the DISPLAY (ADJ) button until the desired display range value is displayed.

2. The unit is now operating with the selected display range.

Locating a Leak

1. Start up the Gas Tracer as described above in "Turning On the Gas Tracer, Leak Check Mode" on page 98.
2. Move the probe tip or tapered nozzle tip back and forth along the area where a leak is suspected.
3. Observe the display reading. If the gas level increases, the numerical reading will increase, the bar graph level will increase, and the beeping and buzzer pulsing frequency will increase.
4. Your gas reading may exceed your display range or 100% LEL. For a description of both scenarios, see the following section.
5. Use the increasing and decreasing of the reading to locate the leak point.
6. To exit Leak Check Mode and return to the Leak Check Mode Select Screen at any time, press and hold the (SHIFT)▼ button for 5 seconds.

Overscale Conditions

There are two overscale conditions that the Gas Tracer may experience while operating in Leak Check Mode.

- Exceeding display range

If you are using a display range of 500, 1000, or 2000 ppm and the gas level goes above the display range, the full scale value of the display range will be displayed but it will not be an overscale condition unless the gas level is above 5000 ppm. If the gas level exceeds 5000 ppm, the ppm sensor will be shut off and the instrument will enter a 30 second warm up period.

- Exceeding 100% LEL

If the combustible gas level exceeds 100% LEL, the Gas Tracer will display an overscale alarm and the ppm sensor will be shut off.

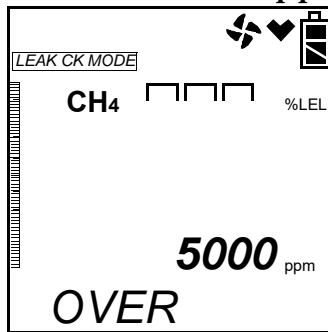

NOTE: If a vol% sensor is installed, “OVER” will still appear at the bottom of the screen but the instrument will display the gas reading in %volume.

The Gas Tracer will continue to be in overscale alarm until the gas reading decreases. The instrument will then enter a 30 second warm up period while the ppm sensor turns on again.

Turning the Alarm On and Off in Leak Check Mode

The alarm buzzer can be turned off and on when the Gas Tracer is in Leak Check Mode. This setting only applies to Leak Check Mode and does not affect buzzer operation in Normal or Bar Hole Mode. When the buzzer is set to Off, NO ALARM appears in the upper left hand corner of the display. If the buzzer is turned off, then it will remain off in Leak Check Mode even if you enter Normal Mode or Bar Hole Mode and return to Leak Check Mode or turn the unit off and on unless the buzzer is manually turned on.

To turn the buzzer off or on while in Leak Check Mode:

1. Press and hold the DISPLAY(ADJ) button for 5 seconds.

NOTE: Pressing and holding the DISPLAY (ADJ) button will change the full scale setting for Leak Check Mode. Once you have made your buzzer selection, use the DISPLAY (ADJ) button to display the desired full scale.

2. Release the button when NO ALARM in the upper left corner appears or disappears.

Peak Hold Mode

Peak Hold Mode allows the user to view the peak methane reading for the operating session while viewing the current methane reading.

To enter Peak Hold Mode:

1. Turn the Gas Tracer on as described in “Turning On the Gas Tracer, Leak Check Mode” on page 98. Select the desired display range. In the example below, 500 ppm has been selected.
2. Press and hold the RESET SILENCE button until the Peak Hold Mode screen displays.

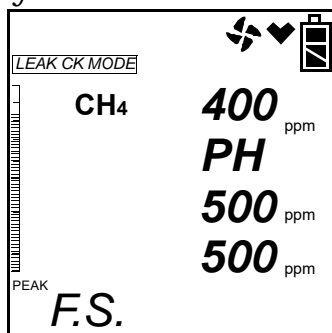

The current methane reading is displayed on the first line. The “PH” shown on the second line indicates that the Gas Tracer is in Peak Hold Mode. The peak methane reading is displayed on the third line. The full scale value is displayed on the fourth line.

3. The peak reading displayed while in Leak Check Mode will appear in the Peak Hold Mode screen.
4. If the highest reading recorded is higher than the full scale value, the full scale value will be displayed. If the full scale value is changed to something higher, the real value for the peak will be displayed. Even if **CO DISP** in Maintenance Mode is turned on, the CO channel will not be displayed in Peak Hold Mode.
5. To reset the peak, press and hold the RESET SILENCE button until you hear a beep, then release it.
6. To exit Peak Hold Mode and return to Leak Check Mode, press and hold the RESET SILENCE button until you hear the Gas

Tracer's second beep and the Leak Check Mode Screen displays.

Snap Log Mode, Leak Check Mode Operation

The snap logging function in Snap Log Mode allows the user to record data at a specific time and have it saved to the data logger. The data is assigned a snap log ID and is saved with the station ID that was selected when the data was taken.

NOTE: If **CO DISP** in Maintenance Mode is turned on and a CO reading is displayed, that CO reading will not be saved in the snap log data.

To enter Snap Log Mode and record snap log data:

1. Turn the Gas Tracer on as described in "Turning On the Gas Tracer, Leak Check Mode" on page 98. Select the desired display range. In the example below, 500 ppm has been selected. Press and hold the (SHIFT)▼ button, then press and hold the AIR▲ button and hold both until you hear a beep. The Station ID Select Screen will display and the current station ID will be flashing.

NOTE: If the gas levels reach a warning or alarm condition while in this screen, the Gas Tracer will go into alarm.

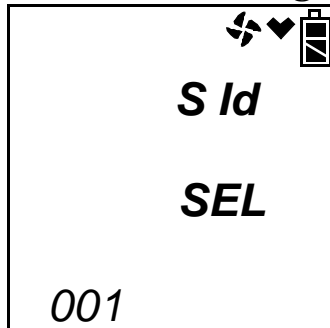

2. Use the (SHIFT)▼ and AIR▲ buttons to scroll to the desired station ID, then press and release the POWER ENTER button to continue to the Base Reading Screen. To return to the Station ID Select Screen without taking a base reading, press and release the RESET SILENCE button.

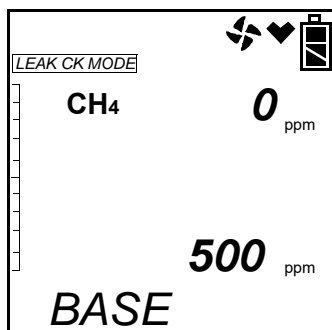

3. In order to get a base, or background, reading, take the instrument a few feet away from where you intend to test. To save the base reading, press and release the POWER ENTER button.

NOTE: If the gas concentration exceeds the display range value without exceeding 5000 ppm, the full scale display range value will be displayed but the actual gas reading at that time will be recorded when you press and release POWER ENTER. For example, if the display range is 500 ppm but the gas level is 2300 ppm, the display will read 500 ppm but the instrument will save a reading of 2300 ppm.

If the gas concentration exceeds 5000 ppm in the Base Reading Screen, the instrument will go into an overscale alarm and turn off the ppm sensor in order to protect it. The full scale display range value will be displayed but OVER will be recorded when you press POWER ENTER. The full scale display range value will continue to be displayed in the Peak Reading Screen and OVER will again be recorded when you press POWER ENTER. The instrument will then enter a 30 second warm up period in order to turn the ppm sensor on again.

4. The unit will display **SAVED** along the bottom of the screen before continuing to the Peak Reading Screen.

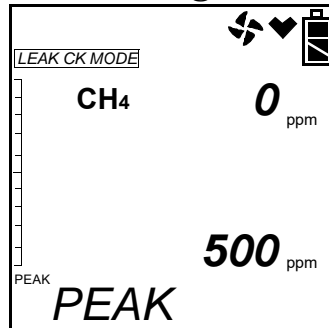

5. Take the instrument to the monitoring area. The instrument will retain and display the highest gas concentration encountered. To save the peak reading, press and release the **POWER ENTER** button. The reading on the screen (the highest concentration encountered) will be saved.

NOTE: If the gas concentration exceeds the display range without exceeding 5000 ppm, the full scale display range value will be displayed but the actual gas reading at that time will be recorded when you press and release **POWER ENTER**. For example, if the display range is 500 ppm but the gas level is 2300 ppm, the display will read 500 ppm but the instrument will save a reading of 2300 ppm.

If the gas concentration exceeds 5000 ppm in the Peak Reading Screen, the instrument will go into an overscale alarm and turn off the ppm sensor in order to protect it. The full scale display range value will be displayed and **OVER** will be recorded when you press **POWER ENTER**. The instrument will then enter a 30 second warm up period in order to turn the ppm sensor on again.

The unit will display **SAVED** along the bottom of the screen before returning to the Station ID Select Screen.

To return to the Station ID Select Screen without taking a peak reading, press and release the **RESET SILENCE** button.

6. Repeat steps 2 through 5 to take additional snap log data.
7. To exit Snap Log Mode at any time without taking a snap log or when you are finished recording snap logs, press and release the **DISPLAY (ADJ)** button. The unit will immediately return to the Normal Operation Screen.
8. The data recorded in Snap Log Mode can be viewed in Display

Mode. See “Snap Logging Screen” on page 56 for more information.

Viewing Snap Log Data in Leak Check Mode Operation

Snap log data can be viewed while in Leak Check Mode. If snap log data was taken while in Normal Operation, that data will also appear.

1. Turn the Gas Tracer on as described in “Turning On the Gas Tracer, Leak Check Mode” on page 98.
2. Press and hold the RESET SILENCE button and then press and hold the DISPLAY (ADJ) button and release both.
3. If no snap logs have been performed, the following screen will appear.

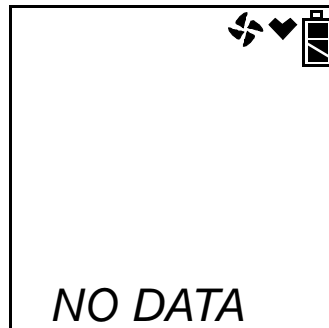

Press and release the DISPLAY (ADJ) button to return to Leak Check Mode.

4. If snap logs have been performed in either Normal Operation or Leak Check Mode Operation, one of the following screens will appear. LEAK CK MODE will appear in the upper left corner of Leak Check Mode Operation data to indicate that the snap log was taken during Leak Check Mode Operation.

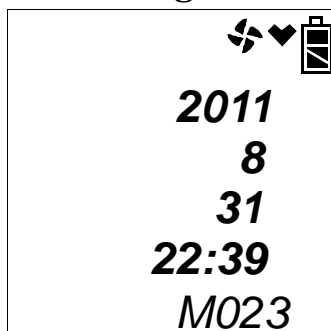

Normal Operation
Snap Log

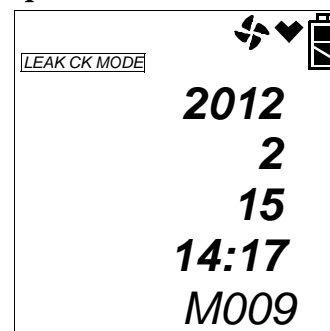

Leak Check Mode Operation
Snap Log

This screen indicates the year, month, day, and time that the most recent snap log was taken. The number along the bottom of the screen indicates the snap log ID number. The first snap log that is taken is given an ID of M001. The next snap log ID is M002. The ID

number increases sequentially with each set of snap log data. Use the AIR▲ and (SHIFT)▼ buttons to scroll through different snap log IDs and view what time and day they were taken. Snap log data that was taken in Leak Check Mode operation will have two snap log ID numbers. One number is for the base reading and the other is for the peak reading.

- To view the data in a snap log ID, press and release the POWER ENTER button. You can also go back and forth between the ID and data screens by pressing and releasing the POWER ENTER button.

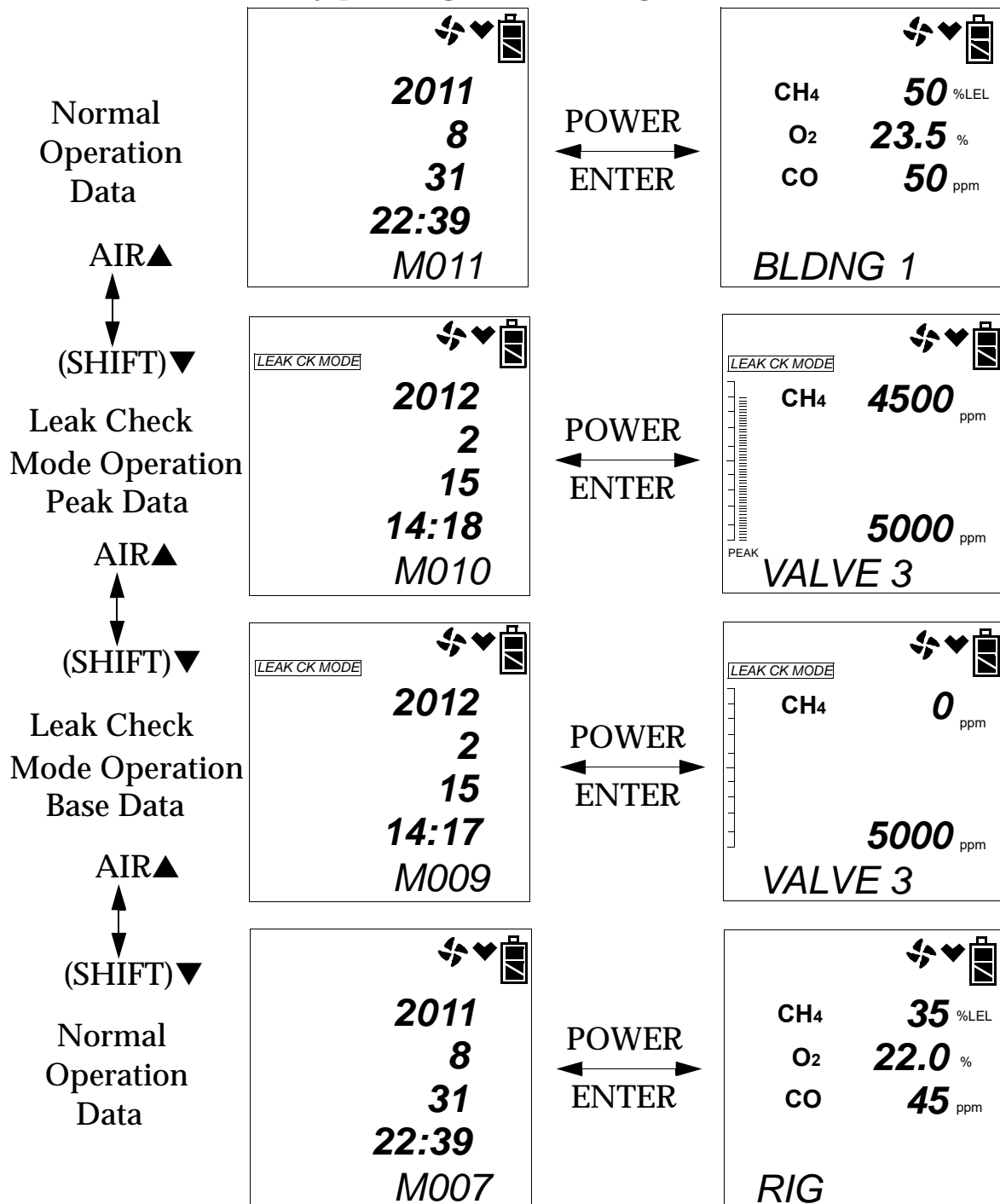

The gas readings that were taken during the snap log are displayed and the Station ID that was in use during the snap log is displayed along the bottom of the screen. Snap log data that was taken in Leak Check Mode operation will have 2 sequential screens that are part of one data set. One screen is for the base reading and the other screen is for the peak reading. The peak reading value will have PEAK displayed below the peak bar. If a base data point appears without a peak data point after it, it is because a peak data point was not taken. You can use the AIR▲ and (SHIFT)▼ buttons to scroll through the different snap logs. The gas readings and station ID will change but the snap log ID is not visible from this screen.

6. To exit snap log data viewing and return to Leak Check Mode Operation, press and release the DISPLAY (ADJ) button.

Turning Off the Gas Tracer, Leak Check Mode

1. Press and hold the POWER ENTER button.
2. The buzzer will pulse for about three seconds and TURN OFF will appear at the bottom of the screen.
3. Release the button when TURN OFF disappears.

Chapter 6: Maintenance Mode

Overview

This chapter describes the Gas Tracer in Maintenance Mode. In Maintenance Mode, you can:

- update the date and time
- perform a fresh air adjust
- perform an auto calibration
- perform a single calibration
- perform a bump test
- calibrate and bump test the PPM combustible sensor
- turn the lunch break setting on or off
- update the alarm latching setting
- turn alarm silencing on or off
- update the interval trend time setting
- update warning, alarm, STEL, and TWA settings
- turn the clear data logger screen on or off
- turn the bump test function on or off
- turn the pump off screen on or off
- update bump test parameters
- update the confirmation beep setting
- update the data logger overwrite setting
- update the calibration interval setting
- turn the calibration reminder function on or off
- update the calibration expired action setting
- update the calibration check setting
- update the bump test interval setting
- turn the bump test reminder function on or off
- update the bump test expired action setting
- update the bump test check setting

- turn the ID display function on or off
- update the backlight settings
- turn the autozero function on or off
- turn the demand zero function on or off
- update the Leak Check/Bar Hole Mode setting
- update the bar hole sampling time
- update the Leak Check Mode CO channel display setting
- view the instrument's firmware version and checksum information
- turn the password function on or off and set the password

The Gas Tracer is factory-set to suit most applications. Update settings in Maintenance Mode only if required for your specific application.

Tips for Using Maintenance Mode

- Use (SHIFT)▼ to scroll down through the main menu and submenus, and to lower values or change the setting in a specific option.
- Use AIR▲ to scroll up through the main menu and submenus, and to raise values or change the setting in a specific option.
- Use the POWER ENTER button to enter a selected menu item, and to enter and save settings that have been updated.
- An adjustable parameter that is flashing can be adjusted with the AIR▲ and (SHIFT)▼ buttons.
- Press the DISPLAY (ADJ) button while entering or updating parameters to exit the screen without saving any changes.

Using Maintenance Mode

WARNING: The Gas Tracer is not in operation as a gas detector while in Maintenance Mode. Although it will respond to gas in parts of AUTO CAL and ONE CAL, there are no alarm indications.

1. Take the Gas Tracer to a non-hazardous location, and turn it off if it is on.

2. Press and hold the AIR▲ and (SHIFT)▼ buttons, then press and hold the POWER ENTER button. When you hear a beep, release the buttons. The unit will prompt you for a password.

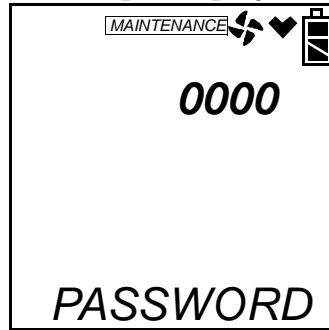

3. Enter the password by using the AIR▲ and (SHIFT)▼ buttons to select each password number and then pressing and releasing POWER ENTER to enter it and move on to the next one. To go back a number, press and release the RESET SILENCE button.

NOTE: A password is always needed to enter Maintenance Mode even if the **PASSWORD** menu item in Maintenance Mode has been turned off (factory setting). The factory set password is 2102. You may change this password by entering the **PASSWORD** menu item in Maintenance Mode.

4. If you enter an incorrect password, an error screen will appear.

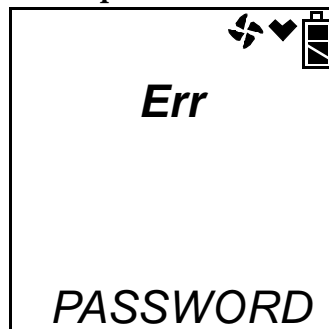

You must turn the unit off and reenter Maintenance Mode using the correct password.

5. Once you enter Maintenance Mode, MAINTENANCE will appear along the top of the screen. The Date Screen displays.

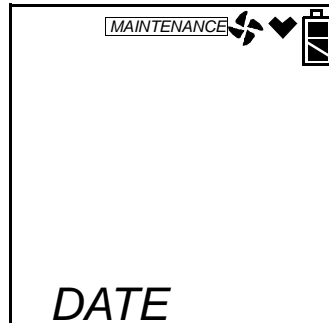

6. Use the AIR▲ or (SHIFT)▼ button to move through the menu item screens.

Updating the Date and Time Settings

1. Use the AIR▲ or (SHIFT)▼ buttons to display the **DATE** menu item.

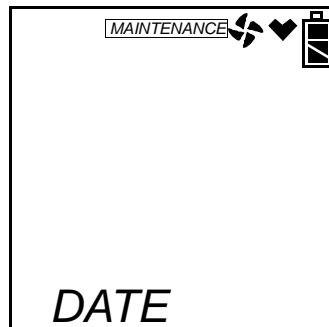

Press and release the POWER ENTER button. The date and time will be displayed with the year flashing.

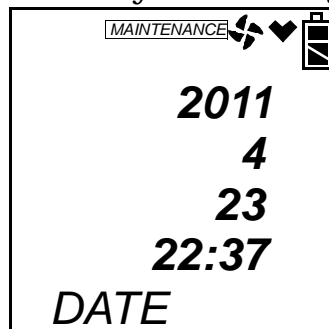

2. Use the AIR▲ or (SHIFT)▼ button to display the desired year.
3. Press and release the POWER ENTER button to save the setting. The month setting flashes.
4. Repeat steps 2 and 3 to enter the month, day, hours, and minutes settings. The Date menu item displays after you enter the minutes setting.

Performing a Fresh Air Adjustment

1. Confirm you are in a fresh air environment that is free of toxic and combustible gases and of normal oxygen concentration, 20.9%.
2. Use the AIR▲ or (SHIFT)▼ buttons to navigate to the **AIR CAL** menu option.



3. Press and release the POWER ENTER button to enter **AIR CAL**. The current gas readings are displayed.

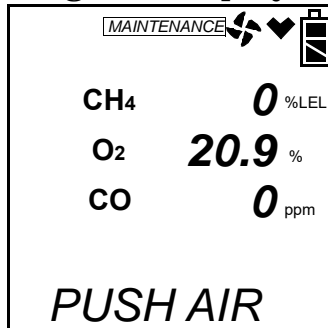

4. Hold down the AIR▲ button. The unit will prompt you to continue holding the AIR▲ button.

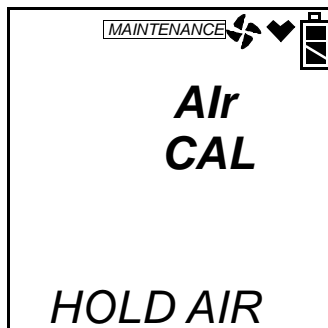

5. When the unit tells you to release the AIR▲ button, release it. The unit will count down from 8 as it performs the fresh air adjust.

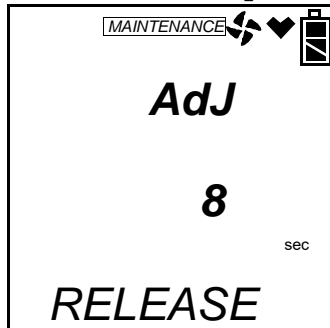

Once it has finished, it will return to the **AIR CAL** menu screen.

Calibrating Using Auto Calibration

If **CL EXPRD** is set to **NOT USE** and calibration becomes due, then the standard 3 gases and the %volume combustible sensor must be calibrated using this menu item and/or the next menu item, **ONE CAL**, because it will not be possible to enter normal operation. The ppm combustible sensor must be calibrated using **PPM CAL**. See “Calibration/Bump Test Supplies and Equipment” on page 61 for the items you will need to perform a calibration. These instructions assume you are using a 3-gas cylinder and a 50% volume methane cylinder.

NOTE: If the combustible gas channels are calibrated to a gas other than methane, use an appropriate multigas cylinder or use single calibration to calibrate the combustible channels.

1. Perform a fresh air adjust. See previous section for instructions.
2. Install the demand flow regulator onto the calibration cylinder.
3. Connect the sample tubing to the demand flow regulator.
4. Install the hose and probe to the Gas Tracer.
5. You may only calibrate either the standard 3 sensors or the % volume combustible gas sensor at a time. Once you are finished, you are returned to the initial **AUTO CAL** screen and must begin the auto calibration process again.
6. Use the AIR▲ or (SHIFT)▼ buttons to display the **AUTO CAL** menu item. Press and release the POWER ENTER button to display the calibration values screen. If you want to exit back to the main menu without completing a calibration, press and release the DISPLAY (ADJ) button.
7. Use the AIR▲ or (SHIFT)▼ buttons to alternate between the 3-gas

and the %volume combustible gas calibration values screens.

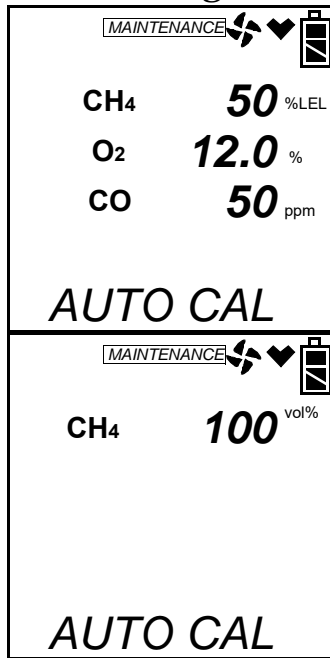

8. The gas concentrations displayed in the calibration values screens must match the gas concentrations listed on the calibration cylinders. If *all* concentrations match, go to step 16. If *one or more* concentrations do not match, continue with step 9.
9. To adjust the values on the screen, hold down the (SHIFT)▼ button, then press the DISPLAY(ADJ) button and release both. %LEL sensor is shown here.

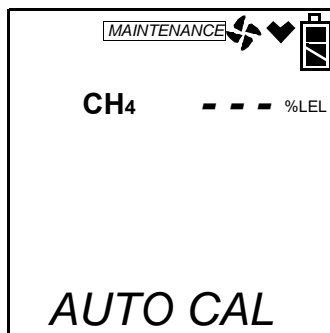

10. If necessary, use the AIR▲ and (SHIFT)▼ buttons to scroll through the sensors and select whose calibration gas value you want to adjust.
11. Press and release the POWER ENTER button. The sensor's calibration gas value will begin to flash.
12. If necessary, use the AIR▲ and (SHIFT)▼ buttons to set the correct calibration gas value.
13. Press and release the POWER ENTER button to save the change.
14. Repeat steps 10 through 13 to set the correct values for any

additional sensors.

15. After the last calibration value is set, use the AIR▲ button to scroll to ESCAPE and press POWER ENTER to return to the calibration gas values screens.

NOTE: The RKI Three Gas Cylinder typically contains 12% O₂ by volume. Be sure to set the “OXY” reading to agree with the concentration listed on the cylinder’s label, not zero.

16. Use the AIR▲ or (SHIFT)▼ button to select which sensor(s) you want to calibrate, the standard 3 sensors or the %volume combustible gas sensor.

The following instructions illustrate calibrating the standard 3 sensors first, then the %volume combustible gas sensor.

17. With the 3-gas calibration values screen displayed, press the POWER ENTER button. AUTO CAL begins to flash and the current gas readings are displayed. If you want to exit back to the main menu without completing a calibration, press and release the DISPLAY (ADJ) button.

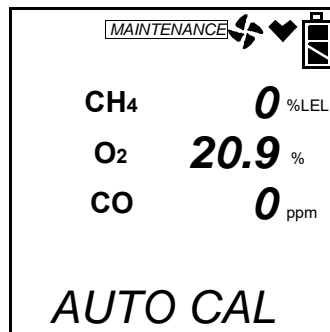

18. Connect the tubing from the demand flow regulator to the rigid tube on the probe. Allow the gas to flow for one minute.
19. Press and release the POWER ENTER button to set the calibration to the programmed values.

If all channels passed calibration, PASS displays along the bottom of the screen, then the calibration menu displays.

If any of the sensors cannot calibrate to the proper value, FAIL displays along the bottom of the screen and the Gas Tracer lists the sensor(s) that failed to calibrate. In the example below, the OXY channel failed calibration. The other sensors calibrated normally.

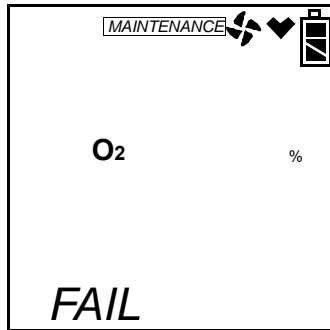

The buzzer and alarm lights activate. Press and release the RESET SILENCE button after the buzzer and lights stop to reset the alarm and return to the calibration menu. Attempt to calibrate again. If the failure continues, investigate the cause. See “Troubleshooting” on page 170.

20. Disconnect the tubing from the probe.
21. Unscrew the demand flow regulator from the calibration cylinder.
22. If you have a 5 sensor unit and wish to calibrate the %volume sensor, go back to step 1 and repeat the process selecting the %volume calibration value screen in step 16 and using a %volume methane cylinder.

If you are finished calibrating, use the (SHIFT)▼ button to navigate to the **NORMAL** menu item, then press and release the POWER ENTER button to return to Measuring Mode.

Calibrating Using Single Calibration

If **CL EXPRD** is set to **NOT USE** and calibration becomes due, then the unit must be calibrated using this menu item and/or the previous menu item, **AUTO CAL** because it will not be possible to enter normal operation. See “Calibration/Bump Test Supplies and Equipment” on page 61 for the items you will need to perform a calibration.

The procedure below describes a span adjustment of one channel using a calibration kit that includes a 3-gas calibration cylinder, a 0.5 LPM (liters per minute) regulator, and non-absorbent sample tubing. The standard 3-gas cylinder consists of 50% LEL methane, 12% oxygen, 50 ppm CO, and a balance of nitrogen. In the example below, the CH₄ channel’s span is adjusted. See “Parts List” on page 186 for available calibration kits and calibration kit spare parts.

Calibration cylinders that contain only one target gas may also be used for single calibration. For channels other than oxygen, RKI Instruments, Inc. recommends that you use a cylinder that contains a concentration of 10-50% of the full scale value of the target gas. For example, if you are calibrating the combustible gas channel, your calibration cylinder should have a combustible gas concentration between 10% LEL and 50% LEL. For the oxygen channel, RKI Instruments, Inc. recommends using 100% nitrogen to perform the adjustment but any concentration between 0% oxygen (100% nitrogen) and 17% oxygen can be used to make the adjustment.

NOTE: If your combustible gas channel is calibrated to a gas other than methane, use an appropriate gas cylinder to perform the calibration.

1. Perform a fresh air adjust. See “Performing a Fresh Air Adjustment” on page 119 for instructions.
2. Install the demand flow regulator onto the calibration cylinder.
3. Connect the sample tubing to the demand flow regulator.
4. Install the hose and probe to the Gas Tracer.
5. Use the AIR▲ or (SHIFT) ▼ buttons to scroll to the **ONE CAL** menu option.



6. Press and release the POWER ENTER button to display the single calibration menu. The %LEL sensor will be displayed first.

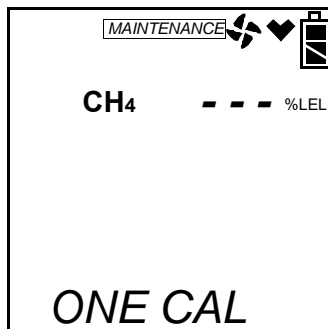

7. Use the AIR▲ or (SHIFT) ▼ button to display the channel you want

to calibrate (in this example the combustible gas % LEL sensor). If you have a 5 sensor unit, the %vol sensor will be one of the choices. It is shown below.

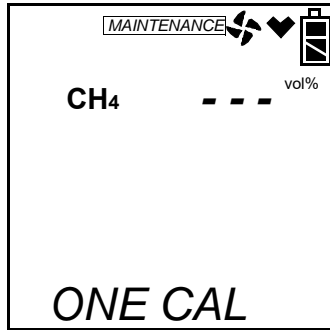

8. Press and release the POWER ENTER button. The single calibration screen displays for the sensor you selected. The gas reading flashes.

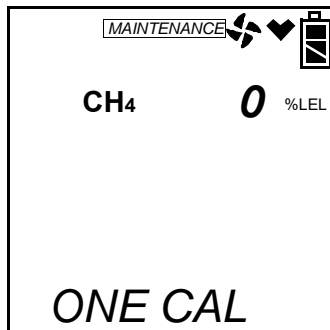

9. Connect the tubing from the demand flow regulator to the rigid tube on the probe. Allow the calibration gas to flow for one minute.
10. If necessary, use the AIR▲ and (SHIFT)▼ buttons to adjust the reading to match the concentration listed on the calibration cylinder.

If the reading already matches the concentration listed on the calibration cylinder, press and release the AIR▲ button then press and release the (SHIFT)▼ button so that the instrument sees a change and resets the calibration date.

11. Press and release the POWER ENTER button to save the span value. The LCD will indicate that the calibration has ended, then the single calibration menu displays.

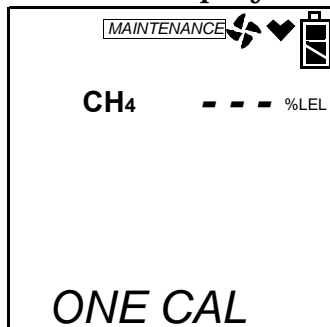

12. Disconnect the tubing from the Gas Tracer's probe.
13. Repeat steps 7 through 12 for any other sensors you want to calibrate. Make sure you use an appropriate calibration cylinder for each sensor.

CAUTION: *When calibrating the oxygen channel, verify the concentration of oxygen listed on the cylinder's label. For oxygen-free samples (100% nitrogen for example), set the oxygen zero setting to 0.0%.*

14. After the last channel is calibrated, disconnect the calibration tubing from the probe, then unscrew the demand flow regulator from the calibration cylinder.
15. Use the AIR▲ and (SHIFT)▼ buttons to scroll to ESCAPE in the ONE CAL menu.
16. With the ONE CAL menu option displayed, press the (SHIFT)▼ button until the NORMAL menu option is displayed.
17. Press and release the POWER ENTER button to return to Measuring Mode.

Performing a Bump Test

NOTE: The **BUMP DSP** menu item in Maintenance Mode is factory set to OFF. The **BUMP** menu item will not appear unless **BUMP DSP** is set to ON. See “Turning the Bump Test Function On or Off” on page 151 for instructions.

NOTE: The Gas Tracer uses parameters defined in the **BUMP--SET** menu item of Maintenance Mode while performing a bump test. To view or update these parameters, see “Updating the Bump Test Parameters” on page 152.

NOTE: If the combustible gas channels are calibrated to a gas other than methane, use an appropriate multigas cylinder.

If the **BP RMNDR** menu item in Maintenance Mode is set to ON (see “Updating the Bump Test Reminder Setting” on page 159), and the **BP EXPRD** menu item in Maintenance Mode is set to NOT USE (see “Updating the Bump Test Expired Action Setting” on page 159) and a bump test becomes due, then the standard 3 sensors must be bump tested using this menu item because it will not be possible to enter normal operation. See “Calibration/Bump Test Supplies and Equipment” on page 61 for the items you will need to perform a

bump test. These instructions assume you are using a 3-gas cylinder and a %volume methane cylinder.

1. Before performing a bump test, perform a fresh air adjustment as described in “Performing a Fresh Air Adjustment” on page 119.
2. Install the demand flow regulator onto the calibration cylinder.
3. Connect the sample tubing to the demand flow regulator.
4. Install the hose and probe to the Gas Tracer.
5. Use the AIR▲ or (SHIFT)▼ buttons to display the **BUMP** menu item.

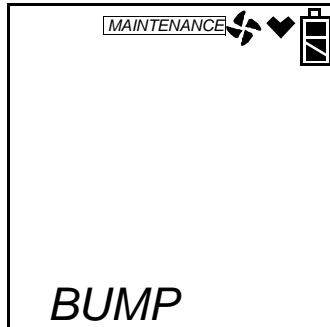

6. Press and release the POWER ENTER button to display the bump test gas values.

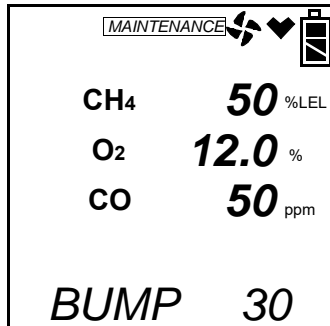

7. Use the AIR▲ or (SHIFT)▼ buttons to see the %volume combustible gas bump test value.

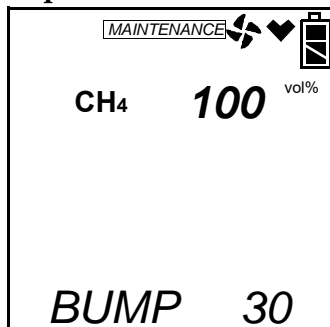

8. A bump test may be performed on the standard 3 sensors or on the %volume combustible sensor. Use the AIR▲ or (SHIFT)▼ buttons to display the screen for the sensor(s) you wish to bump test.

9. Before proceeding, confirm that the bump test gas value(s) are the same as the concentration(s) in the calibration cylinder. If they are not, adjust the bump test gas value(s) by entering the AUTO CAL menu item, changing the values there, and reentering the BUMP menu.
10. Connect the tubing from the demand flow regulator to the rigid tube on the probe, then quickly press and release the POWER ENTER button. The unit will begin counting down from 30.
11. When AUTO CAL in the **BUMP--SET** menu item in Maintenance Mode is set to OFF:
 - The instrument will display which channels passed or failed the bump test with a P (pass) or an F (fail) to the right of the gas.

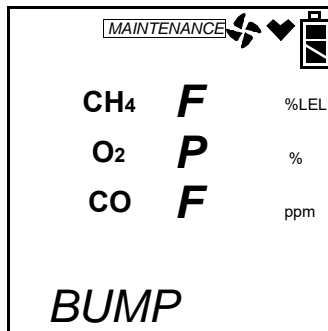

- To view the bump test gas readings press the AIR▲ or (SHIFT)▼ button. You can scroll between the bump test results and the bump test gas readings with the AIR▲ or (SHIFT)▼ button.

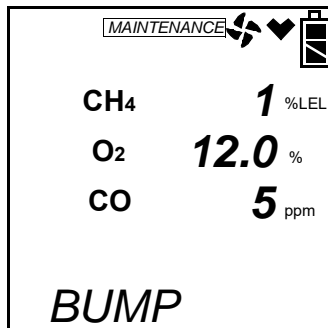

- To return to the BUMP screen in Calibration Mode, press POWER ENTER.

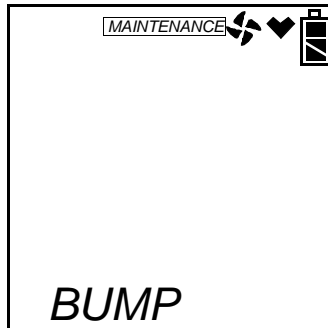

If one or more sensors fail the bump test, see “Troubleshooting” on page 170 to investigate the cause of the failure and replace the failed sensor or sensors if necessary.

- Disconnect the tubing from the probe.

12. When AUTO CAL in the **BUMP--SET** menu item in Maintenance Mode is set to ON:

If all channels pass the bump test,

- The following screen appears:

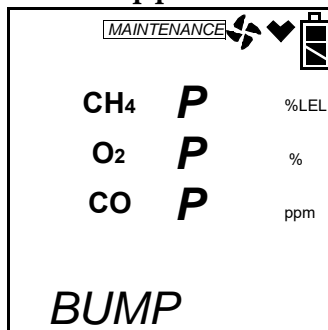

- To view the bump test gas readings press the AIR▲ or (SHIFT)▼ button. You can scroll between the bump test results and the bump test gas readings with the AIR▲ or (SHIFT)▼ button.

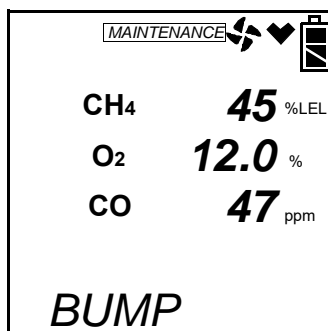

- To return to the main menu, press POWER ENTER.

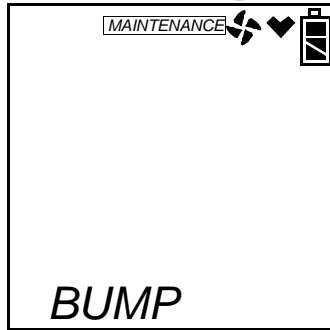

- Disconnect the tubing from the probe.

If any channel fails the bump test,

- The instrument will beep and a calibration is immediately and automatically started. Continue to apply the calibration gas. CAL on the bottom left of the screen will alternate with APPLY.

The calibration time will begin to countdown in seconds in the lower right of the screen. The calibration time counted down during a calibration initiated because of a failed bump test is the difference between the bump test gas time and the calibration time defined in the **BUMP--SET** menu item in Maintenance Mode.

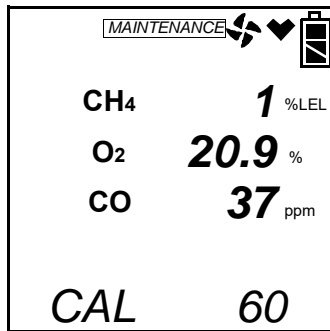

- At the end of the calibration, the instrument displays the results from both the bump test and the calibration. Use the AIR▲ or (SHIFT)▼ buttons to scroll between the calibration/ bump test results, the bump test gas readings, and the calibration gas reading.

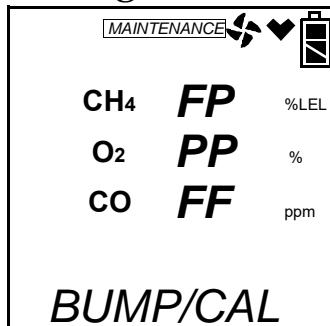

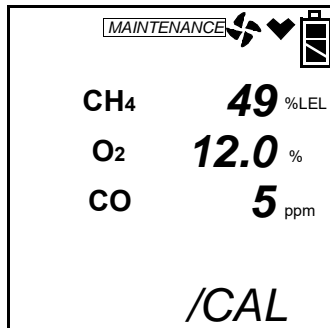
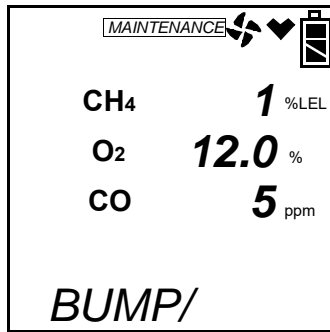

- To return to the **BUMP** screen in Maintenance Mode, press POWER ENTER at any time. If any channel failed the calibration, the buzzer will sound a double pulsing tone until you press and release the POWER ENTER button.

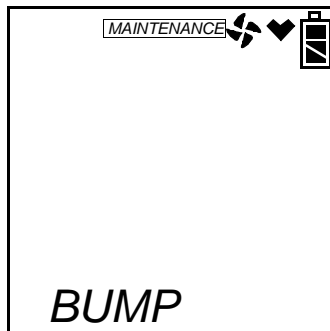

- Disconnect the tubing from the Gas Tracer's probe.
13. Unscrew the demand flow regulator from the calibration cylinder.
 14. With the **BUMP** menu option displayed, press the (SHIFT)▼ button until the **NORMAL** menu option is displayed.
 15. Press and release the POWER ENTER button to return to Measuring Mode.

Calibrating and Bump Testing the PPM Combustible Sensor

The PPM sensor in the Gas Tracer needs to be calibrated and bump tested separately. It cannot be calibrated using the **AUTO CAL** or **ONE CAL** menu items in the main menu or bump tested using the **BUMP** menu item in the main menu. The **PPM CAL** menu item must be used. In addition, a 6 inch humidifier tube must be used to connect the ppm calibration cylinder to the instrument.

1. Use the AIR▲ or (SHIFT)▼ buttons to display the **PPM CAL** Mode item.

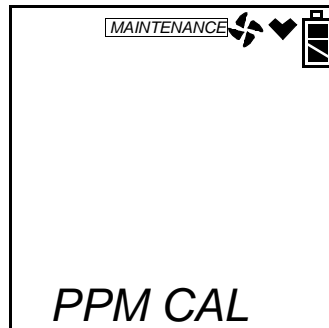

2. Press and release the POWER ENTER button. The display will indicate that the ppm sensor is warming up.

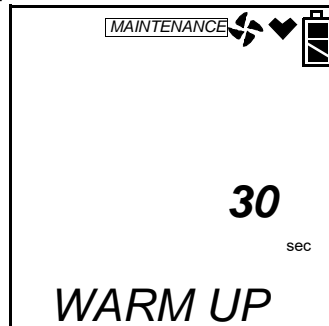

Performing a PPM Fresh Air Adjustment

This section describes how to perform a fresh air adjustment on the PPM combustible gas sensor.

1. Once the warm up is complete, you will be in PPM Cal Mode and AIR CAL will be displayed. You must perform a fresh air adjust before performing an auto calibration, a single calibration, or a bump test.



2. Be sure the Gas Tracer is in a fresh air environment.
3. Press and release the POWER ENTER button to enter the AIR CAL menu item. The unit will display the current fresh air reading and prompt you to push the AIR▲ button.

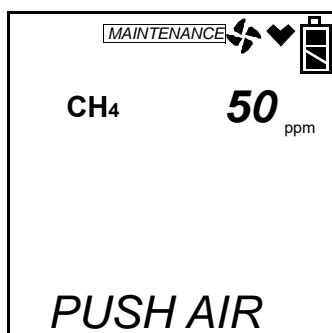

4. Allow the instrument to draw fresh air for 2 minutes.
5. Hold down the AIR▲ button. The unit will prompt you to continue holding the AIR▲ button.



6. When the unit prompts you to release the AIR▲ button, release it. The instrument will perform a fresh air adjustment on the ppm sensor and return you to the AIR CAL menu item.

Performing a PPM AUTO CAL

This section describes how to calibrate the PPM combustible gas sensor using auto calibration.

1. Install the demand flow regulator onto the calibration cylinder.
2. Connect the humidifier to the demand flow regulator.
3. Install the hose and probe to the Gas Tracer.
4. Use the AIR▲ or (SHIFT)▼ buttons to display the AUTO CAL menu item.
5. Press and release the POWER ENTER button. The calibration value screen will be displayed. If you want to exit back to the main menu without completing a calibration, press and release the DISPLAY (ADJ) button.

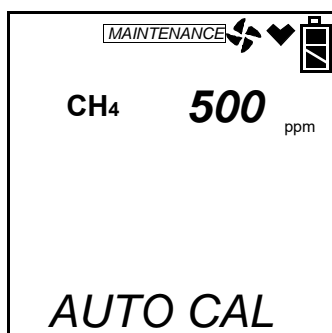

6. The gas concentration displayed in the calibration value screen must match the gas concentration listed on the calibration cylinder. If the concentration matches, go to step 12. If the concentration does not match, continue with step 7.
7. To adjust the value on the screen, hold down the (SHIFT)▼ button, then press the DISPLAY(ADJ) button and release both. The calibration gas value turns into three dashes.

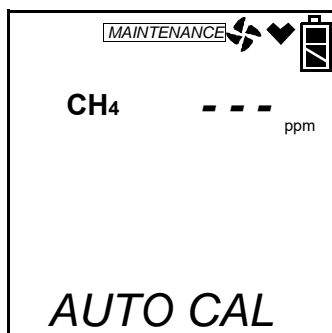

8. Press and release the POWER ENTER button. The sensor's calibration gas value will flash.
9. If necessary, use the AIR▲ and (SHIFT)▼ buttons to set the correct calibration gas value.

10. Press and release the POWER ENTER button to save the change.
11. Use the AIR▲ and (SHIFT)▼ button to scroll to ESCAPE and press POWER ENTER to return to the calibration gas value screen.
12. With the calibration value screen displayed, press the POWER ENTER button. AUTO CAL begins to flash and the current gas reading is displayed. If you want to exit back to the main menu without completing a calibration, press and release the DISPLAY (ADJ) button.

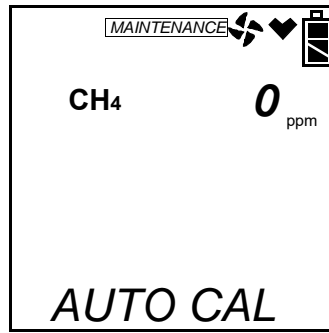

13. Connect the humidifier from the demand flow regulator to the rigid tube on the probe. Allow the gas to flow for two minutes.
14. Press and release the POWER ENTER button to set the calibration to the programmed values.

If the ppm sensor passed calibration, PASS displays along the bottom of the screen, then the AUTO CAL menu item displays.

If the ppm sensor cannot calibrate to the proper value, FAIL displays along the bottom of the screen and the Gas Tracer indicates that the ppm sensor failed to calibrate.

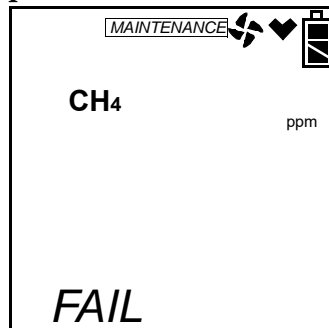

The buzzer and alarm lights activate. Press and release the RESET SILENCE button after the buzzer and lights stop to reset the alarm and return to the AUTO CAL menu item. Attempt to calibrate again. If the failure continues, investigate the cause. See “Troubleshooting” on page 170.

15. Disconnect the humidifier from the probe.

NOTE: Grasp the humidifier tube assembly by the clear tubing at the end, not the humidifier tube itself.

16. Unscrew the demand flow regulator from the calibration cylinder.
17. Use the (SHIFT)▼ button to navigate to the ESCAPE menu item, then press and release the POWER ENTER button to return to the **PPM CAL** menu item in Calibration Mode.
18. Use the (SHIFT)▼ button to navigate to the **NORMAL** menu item, then press and release the POWER ENTER button to return to Measuring Mode.

Performing a PPM Single Calibration

This section describes how to calibrate the PPM combustible gas sensor using single calibration.

1. Install the demand flow regulator onto the calibration cylinder.
2. Connect the humidifier to the demand flow regulator.
3. Install the hose and probe to the Gas Tracer.
4. To calibrate the ppm sensor using single calibration, use the AIR▲ button to scroll to ONE CAL.
5. Press and release the POWER ENTER button. The gas reading will be replaced by 3 dashes. If you want to exit back to the main menu without completing a calibration, press and release the DISPLAY (ADJ) button.

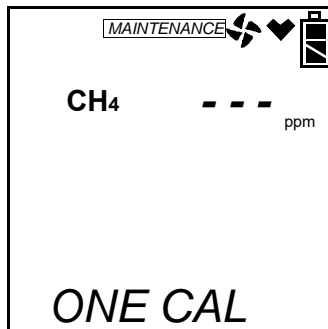

6. Press and release the POWER ENTER button. The single calibration screen displays. The gas reading flashes.

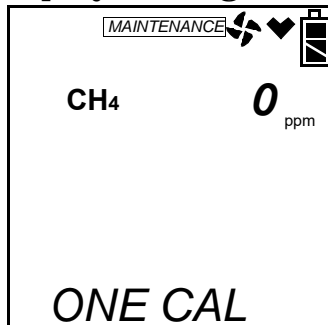

7. Connect the humidifier from the demand flow regulator to the rigid tube on the probe. Allow the calibration gas to flow for two minutes.
8. If necessary, use the AIR▲ and (SHIFT)▼ buttons to adjust the reading to match the concentration listed on the calibration cylinder.

If the reading already matches the concentration listed on the calibration cylinder, press and release the AIR▲ button then press and release the (SHIFT)▼ button so that the instrument sees a change and resets the calibration date.

9. Press and release the POWER ENTER button to save the span value. The LCD will indicate that the calibration has ended, then the **ONE CAL** menu item displays.
10. Disconnect the humidifier from the probe.

NOTE: Grasp the humidifier tube assembly by the clear tubing at the end, not the humidifier tube itself.

11. Unscrew the demand flow regulator from the calibration cylinder.
12. Use the (SHIFT)▼ button to navigate to the **ESCAPE** menu item, then press and release the POWER ENTER button to return to the **PPM CAL** menu in Calibration Mode.
13. Use the (SHIFT)▼ button to navigate to the **NORMAL** menu item, then press and release the POWER ENTER button to return to Measuring Mode.

Performing a PPM Bump Test

NOTE: The **BUMP DSP** menu item in Maintenance Mode is factory set to OFF. The **BUMP** menu item will not appear unless **BUMP DSP** is set to ON. See “Turning the Bump Test Function On or Off” on page 151 for instructions.

NOTE: The Gas Tracer uses parameters defined in the **BUMP--SET** menu item of Maintenance Mode while performing a bump test. To view or update these parameters, see “Updating the Bump Test Parameters” on page 152.

1. Install the demand flow regulator onto the calibration cylinder.
2. Connect the humidifier to the demand flow regulator.
3. Install the hose and probe to the Gas Tracer.

4. While in the **PPM CAL** menu item, use the AIR▲ or (SHIFT)▼ buttons to display the **BUMP** menu item.

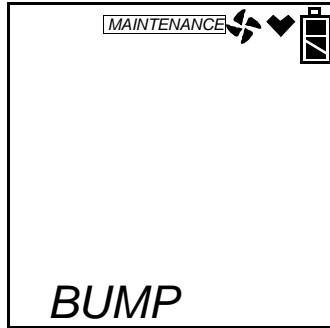

5. Press and release the POWER ENTER button. The bump test gas value will be displayed.

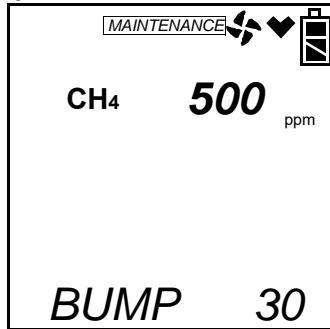

6. Before proceeding, confirm that the bump test gas value is the same as the concentration in the calibration cylinder. If it is not, adjust the bump test gas value by entering the **AUTO CAL** menu item in the **PPM CAL** menu, changing the value there, and reentering the **BUMP** menu.
7. Connect the humidifier from the demand flow regulator to the rigid tube on the probe and quickly press and release the **POWER ENTER** button. The unit will begin counting down from 30.
8. When **AUTO CAL** in the **BUMP--SET** menu item in Maintenance Mode is set to **OFF**:
 - The instrument will display if the ppm combustible sensor passed or failed the bump test with a **P** (pass) or an **F** (fail) to the right of the gas.

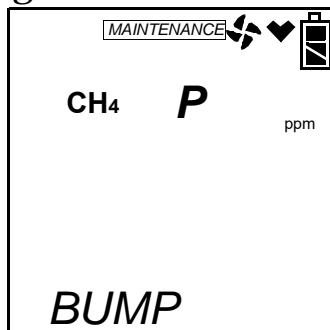

- To view the bump test gas reading press the AIR▲ or (SHIFT)▼ button. You can scroll between the bump test results and the bump test gas reading with the AIR▲ or (SHIFT)▼ button.

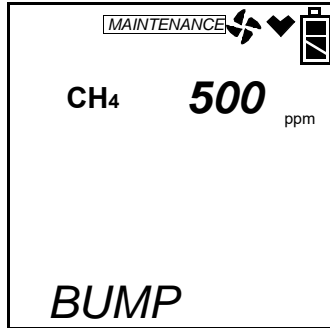

- To return to the BUMP screen in Calibration Mode, press POWER ENTER.

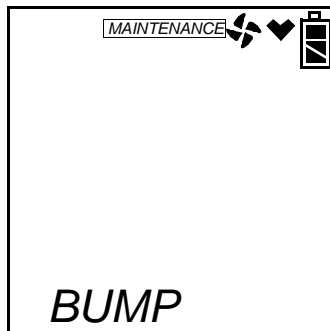

If the sensor fails the bump test, see “Troubleshooting” on page 170 to investigate the cause of the failure and replace the failed sensor if necessary.

- Disconnect the humidifier from the probe.

NOTE: Grasp the humidifier tube assembly by the clear tubing at the end, not the humidifier tube itself.

9. When AUTO CAL in the **BUMP--SET** menu item in Maintenance Mode is set to ON:

If the ppm combustible sensor passes the bump test,

- The following screen appears:

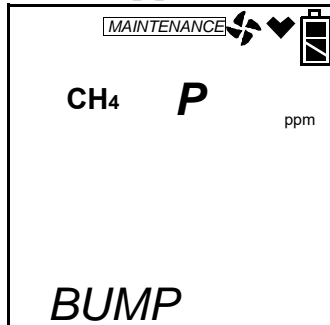

- To view the bump test gas reading press the AIR▲ or (SHIFT)▼ button. You can scroll between the bump test results and the bump test gas reading with the AIR▲ or (SHIFT)▼ button.

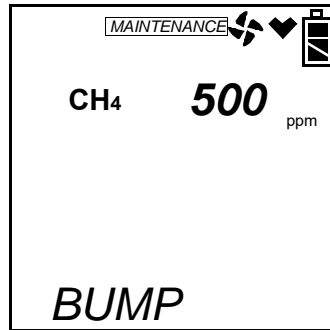

- To return to the BUMP screen in PPM CAL, press POWER ENTER.

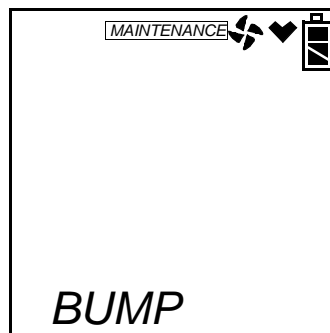

- Disconnect the humidifier from the probe.

NOTE: Grasp the humidifier tube assembly by the clear tubing at the end, not the humidifier tube itself.

If the ppm combustible sensor fails the bump test,

- The instrument will beep and a calibration is immediately and automatically started. Continue to apply the calibration gas. CAL on the bottom left of the screen will alternate with APPLY.

The calibration time will begin to countdown in seconds in the lower right of the screen. The calibration time counted down during a calibration initiated because of a failed bump test is the difference between the bump test gas time and the calibration time defined in the **BUMP--SET** menu item in Maintenance Mode.

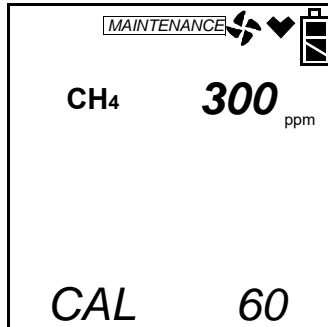

- At the end of the calibration, the instrument displays the results from both the bump test and the calibration. Use the AIR▲ or (SHIFT)▼ button to scroll between the calibration/ bump test results, the bump test gas reading, and the calibration gas reading.

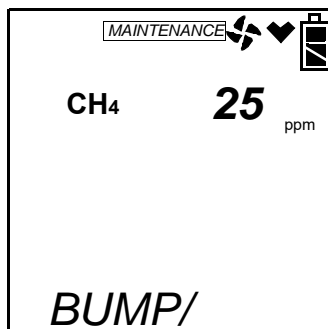
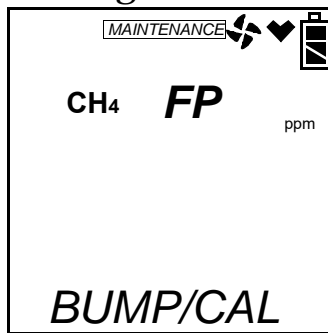

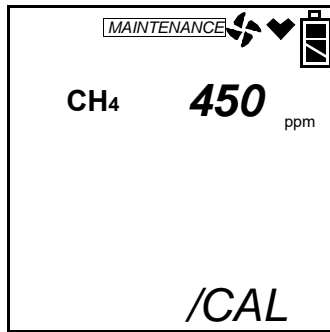

- To return to the BUMP screen in **PPM CAL**, press **POWER ENTER** at any time. If the sensor fails calibration, the buzzer will sound a double pulsing tone until you press and release the **POWER ENTER** button.

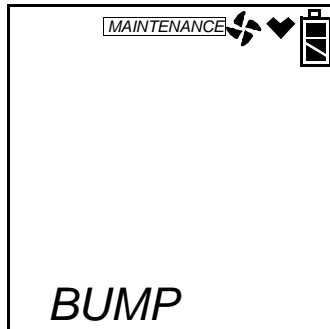

- Disconnect the humidifier from the probe.

NOTE: Grasp the humidifier tube assembly by the clear tubing at the end, not the humidifier tube itself.

10. Unscrew the demand flow regulator from the calibration cylinder.
11. Use the (SHIFT)▼ button to navigate to the **ESCAPE** menu item, then press and release the **POWER ENTER** button to return to the **PPM CAL** menu in Calibration Mode.
12. Use the (SHIFT)▼ button to navigate to the **NORMAL** menu item, then press and release the **POWER ENTER** button to return to Measuring Mode.

Turning the Lunch Break Setting On or Off

With **LNCH BRK** set to **OFF** (factory setting), the Gas Tracer automatically starts new TWA and PEAK reading collection and resets the time in operation at startup.

With **LNCH BRK** set to **ON**, the Resume Measurements Screen displays during startup. From this screen, you can choose to continue accumulating TWA and PEAK readings and the time in operation from the last time the Gas Tracer was used or start collecting new

readings and reset the time in operation.

1. Use the AIR▲ or (SHIFT)▼ buttons to display the **LNCH BRK** menu item.

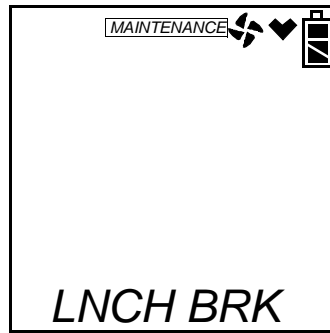

2. Press and release the POWER ENTER button. The screen will indicate the current setting.

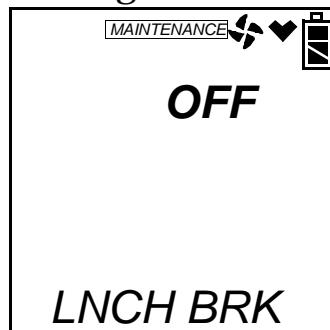

3. Use the AIR▲ or (SHIFT)▼ button to display the desired setting.
4. Press and release the POWER ENTER button to save the setting and return to the main menu.

Updating the Alarm Latching Setting

With **LATCHING** set to **ON** (factory setting), the Gas Tracer remains in alarm condition until the alarm condition passes *and* the POWER ENTER button is pressed.

With **LATCHING** set to **OFF**, the Gas Tracer automatically resets an alarm when the alarm condition passes.

1. Use the AIR▲ or (SHIFT)▼ buttons to display the **LATCHING** menu item.

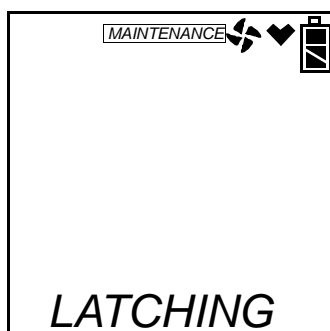

2. Press and release the POWER ENTER button. The screen will indicate the current setting.



3. Use the AIR▲ or (SHIFT)▼ button to display the desired setting.
4. Press and release the POWER ENTER button to save the setting and return to the main menu.

Updating the Alarm Silence Setting

With **ALM SLNC** set to **ON** (factory setting), pressing and releasing the **RESET SILENCE** button silences the buzzer when the Gas Tracer is in alarm. The LEDs continue to flash and the display continues to show the alarm. If the alarms are set up as latching, when the gas concentration falls below the alarm level, pressing and releasing **RESET SILENCE** button clears all alarm indications for that alarm. If an alarm condition occurs, you may still enter Display Mode by pressing the **DISPLAY (ADJ)** button. The buzzer will be silenced but the LEDs will continue to flash and the unit will continue to vibrate. If you return to Measuring Mode and there is still an alarm condition, the LEDs will continue to flash, the unit will continue to vibrate, and the buzzer will remain off. Once the condition clears, press the **RESET SILENCE** button to clear the alarm indications.

With **ALM SLNC** set to **OFF**, you cannot silence the buzzer. If an alarm condition occurs, and you enter Display Mode, the buzzer will not be silenced and the LEDs will continue to flash. Upon return to Measuring Mode, if there is still an alarm condition and the alarms are

set up as latching, you must wait until it clears before you can press the RESET SILENCE button to clear the alarm indications.

1. Use the AIR▲ or (SHIFT)▼ buttons to display the ALM SLNC menu item.



2. Press and release the POWER ENTER button. The screen will indicate the current setting.

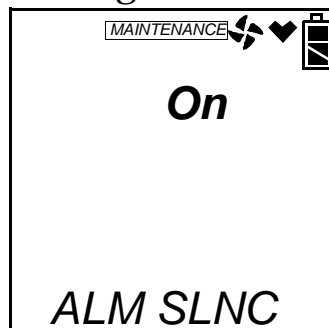

3. Use the AIR▲ or (SHIFT)▼ button to display the desired setting.
4. Press and release the POWER ENTER button to save the setting and return to the main menu.

Updating the Data Log Interval Setting

This setting indicates how often the Gas Tracer saves readings to the data logger. The following interval times can be selected: 6 minutes, 5 minutes, 3 minutes, 1 minute, 30 seconds, 20 seconds, or 10 seconds. The factory setting is 5 minutes (300 seconds).

1. Use the AIR▲ or (SHIFT)▼ buttons to display the LG INTVL menu item.

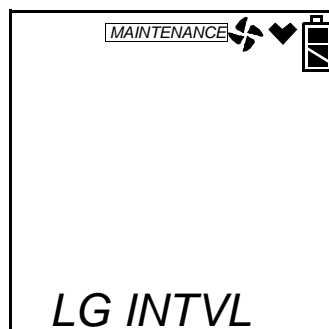

2. Press and release the POWER ENTER button. The screen will indicate the current setting.

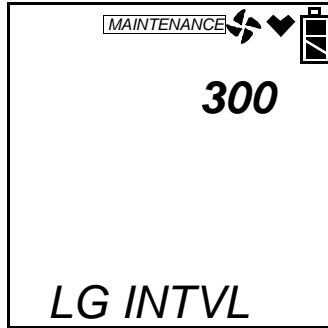

3. Use the AIR▲ or (SHIFT)▼ button to display the desired setting.
4. Press and release the POWER ENTER button to save the setting and return to the main menu.

Updating the Alarm Point Settings

The **ALARM--P** menu item allows you to update one or more warning, alarm, STEL, and TWA (for CO) settings (the reading at which the Gas Tracer recognizes these conditions).

Table 7: Factory Set Alarm Points

Channel	Warning	Alarm	STEL	TWA
Combustible Gas	10% LEL	50% LEL	N/A	N/A
Oxygen	19.5% decreasing	23.5% increasing	N/A	N/A
CO	25 ppm	50 ppm	200 ppm	25 ppm

For the combustible gas channel, it is not possible to adjust either the Warning or Alarm settings to be higher than 60 %LEL. In addition, the Warning setting cannot be adjusted higher than the Alarm setting for all channels.

NOTE: It is not necessary to adjust every setting for every channel when you enter this menu item. All settings are shown here for example.

1. Use the AIR▲ or (SHIFT)▼ buttons to display the **ALARM--P** menu item. Press and release the POWER ENTER button.

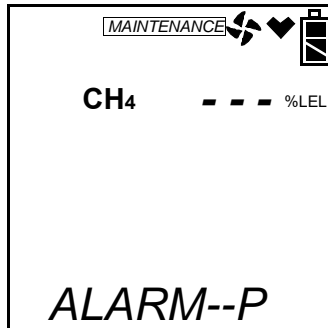

2. You may then select a channel. Use the AIR▲ or (SHIFT)▼ buttons to select a channel. The combustible gas channel is shown for example.
3. Press the POWER ENTER button to display the warning setting for the combustible channel. It will be flashing.



4. Use the AIR▲ or (SHIFT)▼ buttons to change the warning setting.
5. Press POWER ENTER to save the setting. The alarm setting for the combustible gas channel will then be displayed.

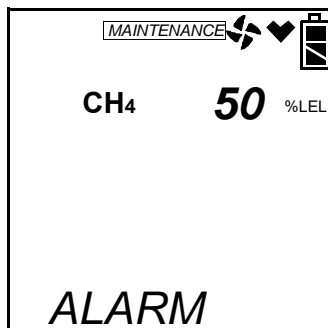

6. Use the AIR▲ or (SHIFT)▼ buttons to change the alarm setting.

7. Press **POWER ENTER** to save the setting. The unit will direct you back to the Alarm Points Screen where you can use the **AIR▲** or **(SHIFT)▼** buttons to select the oxygen channel.

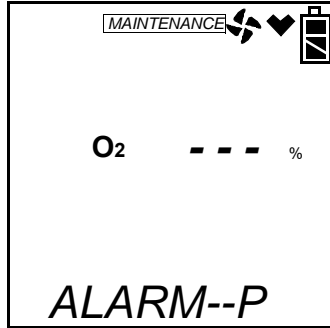

Press **POWER ENTER**.

8. The first selection for the oxygen channel is the alarm pattern.

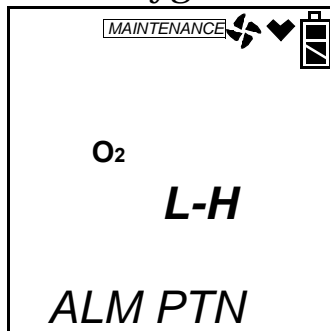

The choices are L-H, L-LL, or H-HH. The L-H pattern provides a decreasing warning and an increasing alarm. The L-LL pattern provides a decreasing warning and a decreasing alarm. The H-HH pattern provides an increasing warning and an increasing alarm. This setup is used for inert applications. For more information on Inert Mode operation, see “Inert Mode” on page 44. Make your selection using the **AIR▲** or **(SHIFT)▼** buttons and press **POWER ENTER** when finished. The factory setting is L-H.

9. You may then adjust the warning setting and alarm setting for the oxygen channel using the **AIR▲** or **(SHIFT)▼** buttons. Press **POWER ENTER** when finished with each selection to return to the Alarm Points Screen.
10. Use the **AIR▲** or **(SHIFT)▼** buttons to select the CO channel and press **POWER ENTER** to display the warning setting.

11. Adjust the values for the warning and alarm settings using the procedure in step 4 through step 7. When you press **POWER ENTER** after selecting the alarm value, you will then be prompted to select the STEL value.

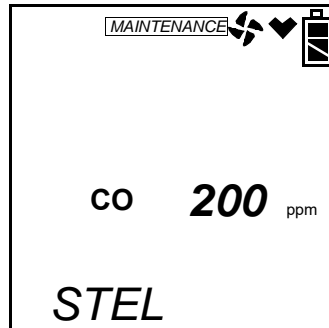

12. Use the **AIR▲** or **(SHIFT)▼** buttons to change the setting and press **POWER ENTER** when finished to save the setting. You will then be asked to enter a TWA value.

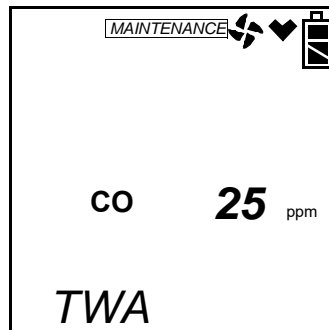

13. Use the **AIR▲** or **(SHIFT)▼** buttons to change the setting and press **POWER ENTER** when finished to save the setting and return to the Alarm Points Screen.

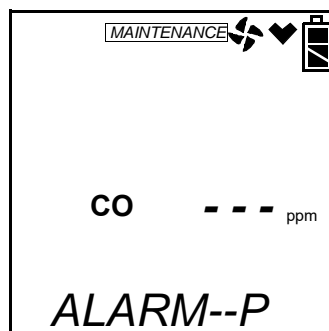

14. When you are finished making adjustments, use the **AIR▲** or **(SHIFT)▼** buttons to select **ESCAPE** and press **POWER ENTER**. You will be returned to the **ALARM--P** screen in the main menu.

Turning the Clear Data Logger Screen On or Off

The **DLOG DSP** menu item allows you to turn the Clear Data Logger Screen on or off. When set to ON (factory setting), the Clear Data Logger Screen appears in Display Mode and allows the user to clear any logged data. When set to OFF, the Clear Data Logger Screen does not appear in Display Mode and any logged data cannot be cleared from Display Mode.

1. Use the AIR▲ or (SHIFT)▼ buttons to display the **DLOG DSP** menu item.

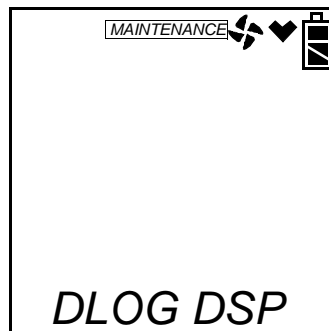

2. Press and release the POWER ENTER button. The screen will indicate the current setting.

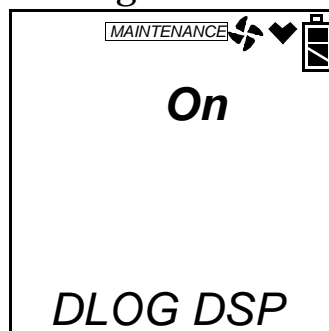

3. Use the AIR▲ or (SHIFT)▼ button to display the desired setting.
4. Press and release the POWER ENTER button to save the setting and return to the main menu.

Turning the Bump Test Function On or Off

The **BUMP DSP** menu item is used to turn the bump test function on or off. If set to OFF, the **BUMP** menu item in Calibration Mode and Maintenance Mode does not appear. In addition, the **BUMP--SET**, **BP INTVL**, **BP RMNDR**, and **BP EXPRD** menu items will not display in Maintenance Mode. The factory setting is **OFF**.

1. Use the AIR▲ or (SHIFT)▼ buttons to display the **BUMP DSP** menu item.

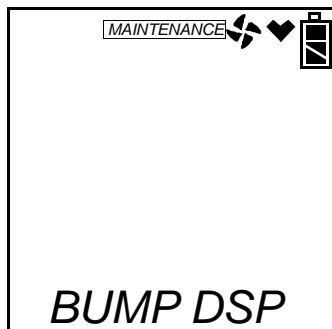

2. Press and release the POWER ENTER button. The screen will indicate the current setting.

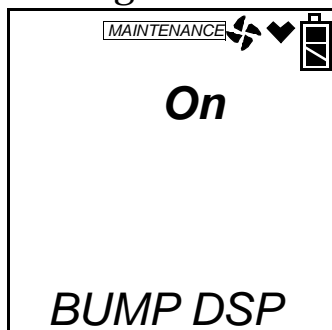

3. Use the AIR▲ or (SHIFT)▼ button to display the desired setting.
4. Press and release the POWER ENTER button to save the setting and return to the main menu.

Turning the Pump Off Screen On or Off

The **POFF DSP** menu item is used to turn the Pump Off Screen on or off. When set to ON, the Pump Off Screen appears in Display Mode and the user can turn off the pump in order to conserve battery power. If set to OFF (factory setting), the Pump Off Screen does not appear in Display Mode and the user cannot turn the pump off.

WARNING: The Gas Tracer is not a gas monitoring device if the pump is turned off.

1. Use the AIR▲ or (SHIFT)▼ buttons to display the **POFF DSP** menu item.

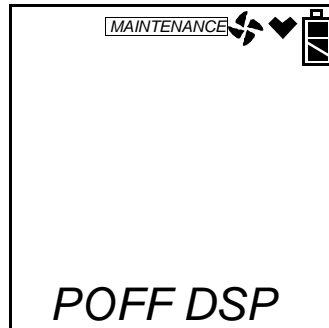

2. Press and release the POWER ENTER button. The screen will indicate the current setting.

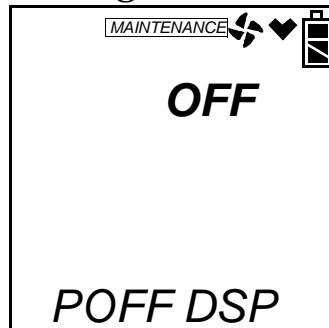

3. Use the AIR▲ or (SHIFT)▼ button to display the desired setting.
4. Press and release the POWER ENTER button to save the setting and return to the main menu.

Updating the Bump Test Parameters

The **BUMP--SET** menu item is used to adjust the bump test parameters.

NOTE: If the **BUMP DSP** menu item is set to OFF, this menu item does not appear.

1. Use the AIR▲ or (SHIFT)▼ buttons to display the **BUMP--SET** menu item.

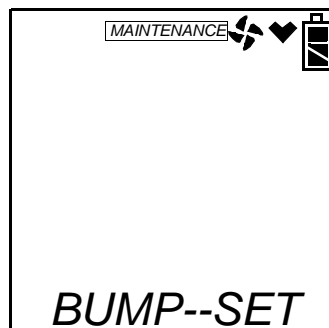

2. Press and release the POWER ENTER button. The values displayed are for GAS TIME, CHECK (bump test tolerance), CAL TIME, and

AUTO CAL. The cursor on the left of the screen shows which setting is associated with the parameter shown at the bottom of the screen. Use the AIR▲ or (SHIFT)▼ buttons to scroll up or down along the list.

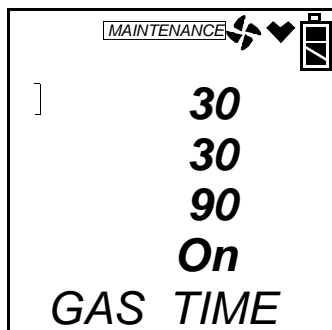

3. To update the GAS TIME setting, with the cursor next to the gas time and with GAS TIME displayed along the bottom of the screen, press POWER ENTER. The factory setting is 30 seconds. The value will begin to flash. Use the AIR▲ or (SHIFT)▼ buttons to select a new gas time. The GAS TIME is the amount of time that the instrument is exposed to gas during a bump test. The time increments are 30, 45, 60, and 90 seconds. Once a value is selected, press and release the POWER ENTER button to save it. The value will stop blinking.
4. To update the bump test tolerance, use the (SHIFT)▼ button to scroll to the CHECK value. The factory setting is 30%. This is the bump test tolerance value and is represented as a percentage. It is the percentage that the bump test reading can differ from the actual gas concentration. If the bump test reading differs more, the bump test will fail. With the cursor next to the check value and CHECK displayed along the bottom of the screen, press and release POWER ENTER. The value will begin to flash. Use the AIR▲ or (SHIFT)▼ buttons to select a new threshold value. The available values are 10, 20, 30, 40, and 50. Once a value is selected, press and release the POWER ENTER button to save it. The value will stop blinking.
5. To update the CAL TIME, use the (SHIFT)▼ button to scroll to the CAL TIME value. The factory setting is 90 seconds. This is the length of time the instrument will remain exposed to calibration gas after a failed bump test if AUTO CAL is set to On. The bump test time is deducted from the calibration time. For example, if the CAL TIME is set to 90 seconds and the GAS TIME is set to 30 seconds, if the bump test fails, the Gas Tracer will only be exposed to gas for an additional 60 seconds. With the cursor next to the cal time value and CAL TIME displayed along the bottom of the

- screen, press and release the POWER ENTER button. The value will begin to flash. Use the AIR▲ or (SHIFT)▼ buttons to select a new cal time value. The choices are 90 and 120 seconds. Once a value is selected, press and release the POWER ENTER button to save it. The value will stop blinking.
- To update the AUTO CAL setting, use the (SHIFT)▼ button to scroll to the AUTO CAL value. The factory setting is ON. With AUTO CAL set to ON, if a bump test fails, the unit will automatically begin a calibration. If AUTO CAL is set to OFF and a bump test fails, nothing will happen. With the cursor next to the auto cal selection and AUTO CAL displayed along the bottom of the screen, press and release the POWER ENTER button. The value will begin to flash. Use the AIR▲ or (SHIFT)▼ buttons to select ON or OFF. Once a selection is made, press and release the POWER ENTER button to save it. The value will stop blinking.
 - To exit the **BUMP--SET** menu, use the (SHIFT)▼ button to scroll to ESCAPE and press and release the POWER ENTER button.

Updating the Confirmation Beep Setting

With **BEEP. SET** set to ON, the Gas Tracer beeps once every 5 minutes to verify that it is operating.

With **BEEP. SET** set to OFF (factory setting), the Gas Tracer does not sound a confirmation beep.

- Use the AIR▲ or (SHIFT)▼ buttons to display the **BEEP. SET** menu item. Press and release the POWER ENTER button. The screen will indicate the current setting.

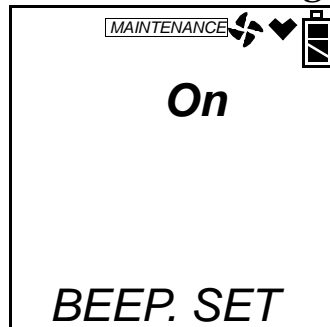

- Use the AIR▲ or (SHIFT)▼ button to display the desired setting.
- Press and release the POWER ENTER button to save the setting and return to the main menu.

Updating the Datalog Overwrite Setting

With **OVER WRT** set to ON (factory setting), the Gas Tracer writes over the oldest data with new data when the data logger memory is

full.

With **OVER WRT** set to **OFF**, the Gas Tracer stops saving data to the data logger when the data logger memory is full.

1. Use the AIR▲ or (SHIFT)▼ buttons to display the **OVER WRT** menu item. Press and release the POWER ENTER button. The screen will indicate the current setting.

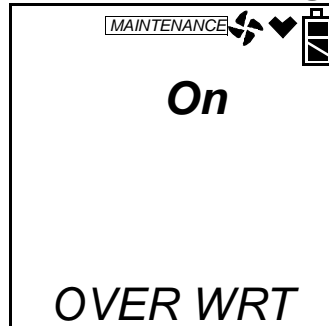

2. Use the AIR▲ or (SHIFT)▼ button to display the desired setting.
3. Press and release the POWER ENTER button to save the setting and return to the main menu.

Updating the Calibration Interval

This **CL INTVL** setting defines the amount of time between calibrations. The minimum setting is 1 day and the maximum setting is 365 days. The factory setting is 90 days.

1. Use the AIR▲ or (SHIFT)▼ buttons to display the **CL INTVL** menu item. Press and release the POWER ENTER button. The screen will indicate the current setting.

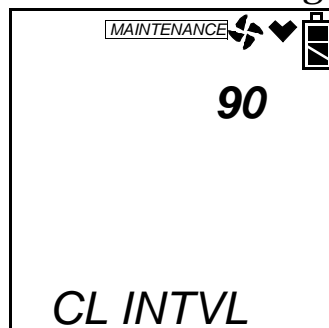

2. Use the AIR▲ or (SHIFT)▼ button to display the desired setting.

Tip: Press and hold the AIR▲ or (SHIFT)▼ button to rapidly scroll through the settings.

3. Press and release the POWER ENTER button to save the setting and return to the main menu.

Updating the Calibration Reminder Setting

With **CL RMNDR** set to **ON** (factory setting), the Gas Tracer will give an indication at start up if it is due for calibration. The type of indication will depend on the **CL EXPRD** setting (see below).

1. Use the **AIR▲** or **(SHIFT)▼** buttons to display the **CL RMNDR** menu item. Press and release the **POWER ENTER** button. The screen will indicate the current setting.

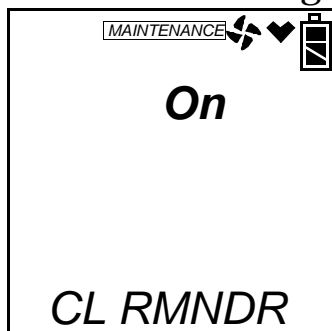

2. Use the **AIR▲** or **(SHIFT)▼** button to display the desired setting.
3. Press and release the **POWER ENTER** button to save the setting and return to the main menu.

Updating the Calibration Expired Action Setting

This item defines what indication is given during start up when calibration is due and **CL RMNDR** is set to **ON**.

With **CL EXPRD** set to **CONFIRM** (factory setting), the Gas Tracer will give an indication at start up if calibration is due and require the user to press the **RESET SILENCE** button to continue.

With **CL EXPRD** set to **NOT USE**, if the unit is due for calibration the Gas Tracer will give an indication at start up that calibration is due and the unit cannot be used until it is calibrated. With this setting, it is necessary to calibrate the instrument from Maintenance Mode if calibration is not performed before it is due. See “Calibrating Using Auto Calibration” on page 120, “Calibrating Using Single Calibration” on page 123, or “Calibrating and Bump Testing the PPM Combustible Sensor” on page 132 for instructions.

With **CL EXPRD** set to **NO EFFECT**, no confirmation during startup or calibration is required to use the Gas Tracer if calibration is overdue.

1. Use the AIR▲ or (SHIFT)▼ buttons to display the **CL EXPRD** menu item. Press and release the POWER ENTER button. The screen will indicate the current setting.

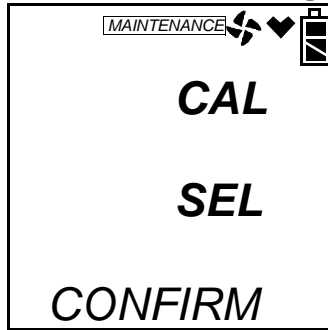

2. Use the AIR▲ or (SHIFT) ▼ button to display the desired setting along the bottom of the screen.
3. Press and release the POWER ENTER button to save the setting and return to the main menu.

Updating the Calibration Check Setting

This item setting defines which sensors are used to update the calibration reminder screen. **C--CHECK** can be set to 4-GAS or ALL. If **C--CHECK** is set to 4-GAS (factory setting), the calibration dates for only the standard sensors (LEL, O₂, and CO) are used to determine if calibration is due. If **C--CHECK** is set to ALL, the calibration dates for the standard sensors along with the %volume sensor and the ppm combustible gas sensor are used to determine if a calibration is due.

1. Use the AIR▲ or (SHIFT)▼ buttons to display the **C--CHECK** menu item. Press and release the POWER ENTER button. The screen will indicate the current setting.

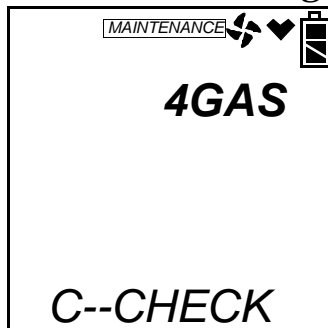

2. Use the AIR▲ or (SHIFT)▼ button to display the desired setting.
3. Press and release the POWER ENTER button to save the setting and return to the main menu.

Updating the Bump Test Interval

The **BP INTVL** setting defines the amount of time between bump tests. The minimum setting is 0 days and the maximum setting is 30 days. The factory setting is 30 days.

NOTE: If the **BUMP DSP** menu item is set to OFF, this menu item does not appear.

1. Use the AIR▲ or (SHIFT)▼ buttons to display the **BP INTVL** menu item. Press and release the POWER ENTER button. The screen indicates the current setting.

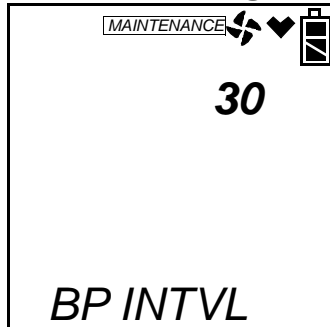

2. Use the AIR▲ or (SHIFT)▼ button to display the desired setting.

Tip: Press and hold the AIR▲ or (SHIFT)▼ button to rapidly scroll through the settings.

3. Press and release the POWER ENTER button to save the setting and return to the main menu.

Updating the Bump Test Reminder Setting

With **BP RMNDR** set to **ON**, the Gas Tracer will give an indication at start up if it is due for bump testing. The type of indication will depend on the **BP EXPRD** setting (see below).

With **BP RMNDR** set to **OFF** (factory setting), the Gas Tracer will give no indication at start up if it is due for bump testing.

NOTE: If the **BUMP DSP** menu item is set to **OFF**, this menu item does not appear.

1. Use the **AIR▲** or **(SHIFT)▼** buttons to display the **BP RMNDR** menu item. Press and release the **POWER ENTER** button. The screen will indicate the current setting.



2. Use the **AIR▲** or **(SHIFT)▼** button to display the desired setting.
3. Press and release the **POWER ENTER** button to save the setting and return to the main menu.

Updating the Bump Test Expired Action Setting

This item defines what indication is given during start up when a bump test is due and **BP RMNDR** is set to **ON**.

With **BP EXPRD** set to **CONFIRM** (factory setting), the Gas Tracer will give an indication at start up if a bump test is due and require the user to press the **RESET SILENCE** button to continue.

With **BP EXPRD** set to **NOT USE**, if the unit is due for a bump test the Gas Tracer will give an indication at start up that the bump test is due and the unit cannot be used until it is bump tested. With this setting, it is necessary to bump test the instrument from the Maintenance Mode if a bump test is not performed before it is due. See “Performing a Bump Test” on page 126 and “Calibrating and Bump Testing the PPM Combustible Sensor” on page 132 for instructions.

With **BP EXPRD** set to **NO EFFECT**, no confirmation during startup or bump test is required to use the Gas Tracer.

NOTE: If the **BUMP DSP** menu item is set to OFF, this menu item does not appear.

1. Use the AIR▲ or (SHIFT)▼ buttons to display the **BP EXPRD** menu item. Press and release the POWER ENTER button. The screen will indicate the current setting.

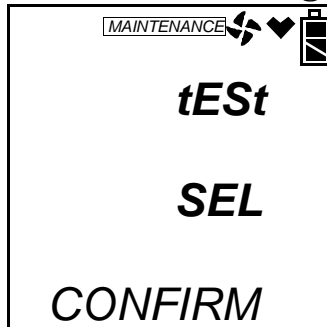

2. Use the AIR▲ or (SHIFT) ▼ button to display the desired setting along the bottom of the screen.
3. Press and release the POWER ENTER button to save the setting and return to the main menu.

Updating the Bump Test Check Setting

This item setting defines which sensors are used to update the bump test reminder screen. **B--CHECK** can be set to 4-GAS or ALL. If **B--CHECK** is set to 4-GAS (factory setting), the calibration dates for only the standard sensors (LEL, O₂, and CO) are used to determine if a bump test is due. If **B--CHECK** is set to ALL, the calibration dates for the standard sensors along with the %volume sensor and the ppm combustible gas sensor are used to determine if a bump test is due.

1. Use the AIR▲ or (SHIFT)▼ buttons to display the **B--CHECK** menu item. Press and release the POWER ENTER button. The screen will indicate the current setting.

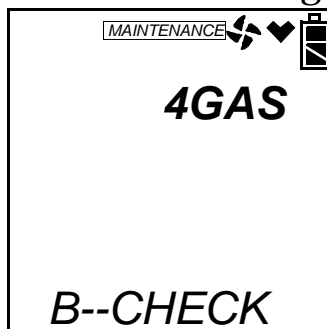

2. Use the AIR▲ or (SHIFT)▼ button to display the desired setting.
3. Press and release the POWER ENTER button to save the setting and return to the main menu.

Turning the ID Display Function On or Off

With **ID DISP** set to **ON**, the User ID Screen and Station ID Screens display during start up.

With **ID DISP** set to **OFF** (factory setting), the User ID Screen and Station ID Screens do not display during start up.

The User ID Screen and Station ID Screen always appear in Display Mode, regardless of the **ID DISP** setting.

1. Use the **AIR▲** or **(SHIFT)▼** buttons to display the **ID DISP** menu item. Press and release the **POWER ENTER** button. The screen will indicate the current setting.

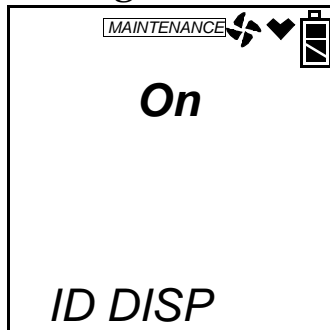

2. Use the **AIR▲** or **(SHIFT) ▼** button to display the desired setting.
3. Press and release the **POWER ENTER** button to save the setting and return to the main menu.

Updating the LCD Back Light Time Setting

The **BCK LGHT** setting indicates the length of time the LCD illuminates when you press any button. The minimum setting is 0 seconds; the maximum setting is 255 seconds. The factory setting is 30 seconds.

NOTE: The backlight stays on during the entire warmup sequence.

1. Use the **AIR▲** or **(SHIFT)▼** buttons to display the **BCK LGHT** menu item. Press and release the **POWER ENTER** button. The screen will indicate the current setting.

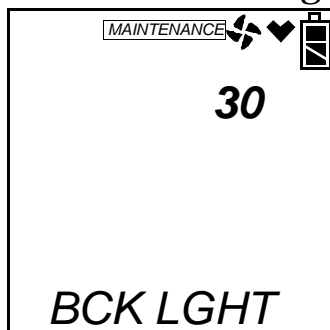

2. Use the AIR▲ and (SHIFT)▼ buttons to display the desired setting.
3. Press and release the POWER ENTER button to save the setting and return to the main menu.

Updating the Autozero Function

With **AUTO.ZERO** turned **ON**, the Gas Tracer will automatically perform a fresh air adjust when it is turned on. With **AUTO.ZERO** function turned **OFF** (factory setting), this does not occur.

WARNING: *If you turn on the autozero function, you must ensure that the unit is in a fresh air environment when it is turned on.*

1. Use the AIR▲ or (SHIFT)▼ buttons to display the **AUTO.ZERO** menu item. Press and release the POWER ENTER button. The screen will indicate the current setting.

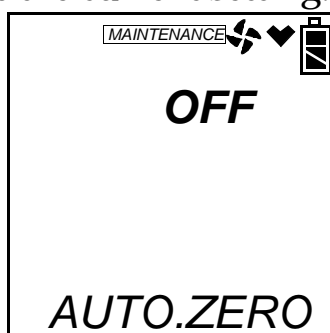

2. Use the AIR▲ or (SHIFT) ▼ button to display the desired setting.
3. Press and release the POWER ENTER button to save the setting and return to the main menu.

Updating the Demand Zero Function

The **DEMAND Z** function allows you to manually perform a fresh air adjust in normal operation by pressing the AIR▲ button. The factory setting is **ON**.

1. Use the AIR▲ or (SHIFT)▼ buttons to display the **DEMAND Z** menu item. Press and release the POWER ENTER button. The

screen will indicate the current setting.

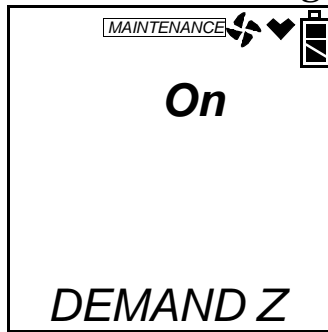

2. Use the AIR▲ or (SHIFT) ▼ button to display the desired setting.
3. Press and release the POWER ENTER button to save the setting and return to the main menu.

Updating the Leak Check/Bar Hole Mode Setting

With **L./B. MODE** turned **OFF**, the Gas Tracer will automatically enter Normal Mode when it is turned on.

With **L./B. MODE** set to **bH**, you will be prompted to choose between Normal Mode and Bar Hole Mode when the Gas Tracer is turned on.

With **L./B. MODE** set to **LC** (factory setting), you will be prompted to choose between Normal Mode and Leak Check Mode when the Gas Tracer is turned on.

With **L./B. MODE** set to **LC bH**, you will be prompted to choose between Normal Mode, Bar Hole Mode, and Leak Check Mode when the Gas Tracer is turned on.

1. Use the AIR▲ or (SHIFT)▼ buttons to display the **L./B. MODE** menu item.

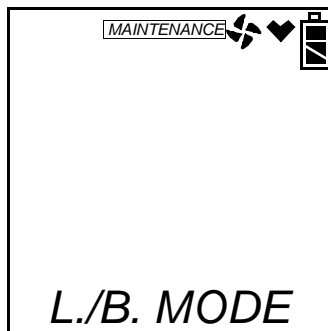

2. Press and release the POWER ENTER button. The screen will

indicate the current setting.

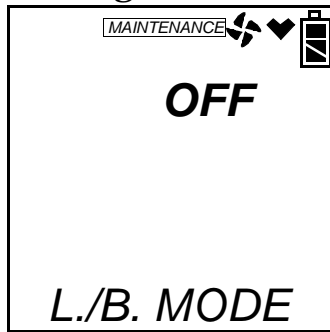

3. Use the AIR▲ or (SHIFT) ▼ button to display the desired setting.
4. Press and release the POWER ENTER button to save the setting and return to the main menu.

Updating the Bar Hole Sampling Time

The Bar Hole Sampling Time is the amount of time that the Gas Tracer samples a bar hole when being used in Bar Hole Mode. The 3 selections are 30, 45, and 60 seconds. The factory setting is 30 seconds.

1. Use the AIR▲ or (SHIFT)▼ buttons to display the **B.H. TIME** menu item.

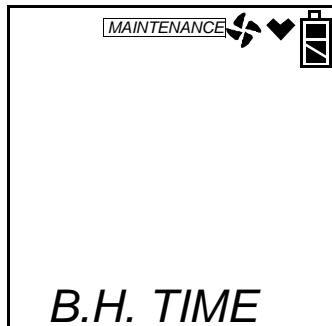

2. Press and release the POWER ENTER button. The screen will indicate the current setting.

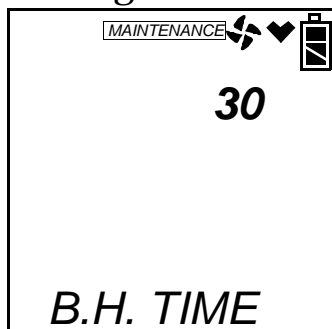

3. Use the AIR▲ or (SHIFT) ▼ button to display the desired setting.
4. Press and release the POWER ENTER button to save the setting and return to the main menu.

Updating the Leak Check Mode CO Channel Display Setting

With **CO DISP** set to **OFF** (factory setting), the CO channel is not displayed in Leak Check Mode but is still displayed in Normal Mode.

With **CO DISP** set to **On**, the CO channel will be displayed in Leak Check Mode but there will be no CO alarms and the CO channel reading will not be saved to any snap log data taken during the operating session.

1. Use the AIR▲ or (SHIFT)▼ buttons to display the **CO DISP** menu item.

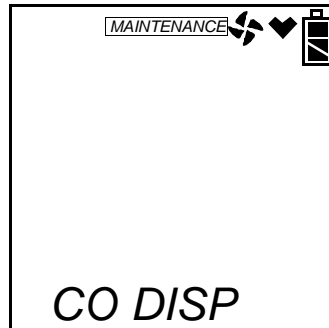

2. Press and release the POWER ENTER button. The screen will indicate the current setting.

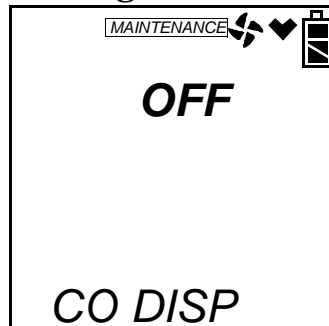

3. Use the AIR▲ or (SHIFT) ▼ button to display the desired setting.
4. Press and release the POWER ENTER button to save the setting and return to the main menu.

ROM/SUM

The **ROM/SUM** screen shows the firmware version that is loaded in the instrument and the firmware checksum.

1. Use the AIR▲ button to scroll to the ROM/SUM screen. Press POWER ENTER and the ROM and SUM values for your unit will be displayed.

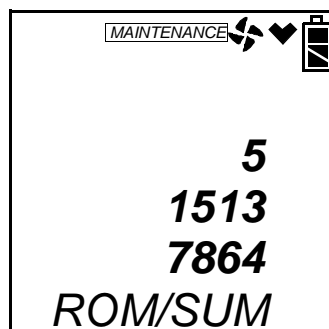

The first two lines display the ROM number. The ROM number indicates the firmware version number. In the above example, the ROM number is 51513. The bottom line displays the SUM number, 7864 in the above example.

2. Press **POWER ENTER** again to return to the ROM/SUM menu screen.

Turning the Password Function On or Off

With **PASSWORD** set to **ON**, the Gas Tracer prompts you for a password when you enter Calibration Mode.

With **PASSWORD** set to **OFF** (factory setting), no password is required to enter Calibration Mode.

NOTE: A password is always required to enter Maintenance Mode even if **PASSWORD** is turned OFF. You may change the factory set password by turning **PASSWORD** ON and entering a new password when prompted for it.

1. Use the **AIR▲** or **(SHIFT)▼** buttons to display the **PASSWORD** menu item. Press and release the **POWER ENTER** button. The screen indicates the current setting.

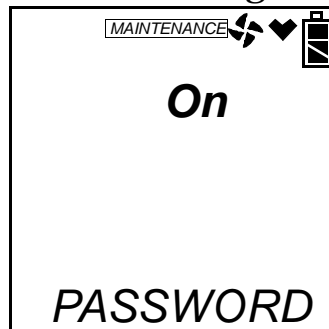

2. Use the **AIR▲** or **(SHIFT)▼** button to display the desired setting.
3. If you selected **OFF**, press and release the **POWER ENTER** button to save the setting and return to the main menu.

If you selected **ON**, press and release the **POWER ENTER** button. **ON** is replaced by the four characters making up the current password.

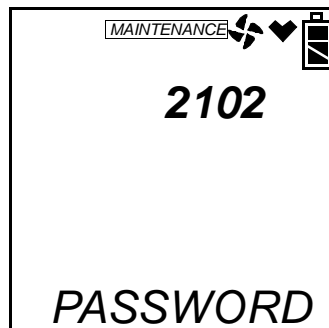

4. Use the **AIR▲** or **(SHIFT)▼** button to select a number from 0 to 9.
5. Press and release the **POWER ENTER** button to enter the selection and advance to the next character.

6. Repeat steps 4 and 5 to select the remaining characters. When you press and release the POWER ENTER button to enter the last number, the password is saved and you return to the main menu.

Performing a Low Flow Setpoint Adjustment

If your instrument repeatedly goes into low flow alarm and you have tried all of the recommendations in the Troubleshooting section, you may need to perform a low flow setpoint adjustment.

1. Use the AIR▲ or (SHIFT)▼ buttons to display the **FLOW ADJ** menu item. Press and release the POWER ENTER button. The pump will turn off and the screen will display values that reflect the pump's current draw.

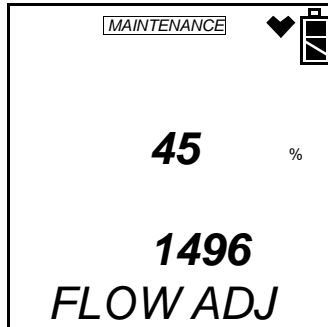

2. Use the AIR▲ or (SHIFT)▼ buttons to get a reading of approximately 1500 on the bottom value. When you have adjusted the value as close as you can, press and release the POWER ENTER button.
3. The pump will turn on and two new values will be displayed. The top will be a reference value and the bottom will reflect the pump's current draw.

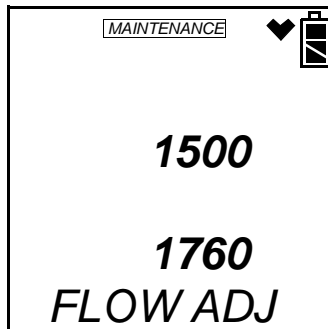

Connect a flow meter to the inlet of the instrument and adjust it to 0.5 SCFH \pm 0.1 SCFH. This will be the low flow setpoint. You do not need to adjust anything at the instrument. Once the desired low flow setpoint is set, press and release the POWER ENTER button.

4. You will return to the **FLOW ADJ** menu item in Maintenance Mode.

Exiting Maintenance Mode

1. Use the AIR▲ or (SHIFT)▼ buttons to display the **START** menu item. Press and release the POWER ENTER button.
2. The unit will exit Maintenance Mode and begin its start up sequence.

Chapter 7: Gas Tracer Maintenance

Overview

This chapter describes troubleshooting procedures for the Gas Tracer. It also includes procedures for recharging the battery pack (rechargeable version), replacing the alkaline batteries (alkaline version), and replacing various consumable parts.

WARNING: RKI Instruments, Inc. recommends that service, calibration, and repair of RKI instruments be performed by personnel properly trained for this work. Replacing sensors and other parts with original equipment does not affect the intrinsic safety of the instrument.

Troubleshooting

The troubleshooting table describes error messages, symptoms, probable causes, and recommended action for problems you may encounter with the Gas Tracer.

Table 8: Troubleshooting the Gas Tracer

Symptoms	Probable Causes	Recommended Action
<ul style="list-style-type: none">• The LCD is blank.	<ul style="list-style-type: none">• The unit may have been turned off.• The alkaline batteries may need to be replaced or the lithium ion battery pack recharged.	<ol style="list-style-type: none">1. To turn on the unit, press and briefly hold the POWER ENTER button.2. If the unit does not turn on, replace the alkaline batteries or recharge the lithium ion battery pack.3. If the difficulties continue, contact RKI Instruments, Inc. for further instruction.

Table 8: Troubleshooting the Gas Tracer

Symptoms	Probable Causes	Recommended Action
<ul style="list-style-type: none"> • Display indicates “FAIL SYSTEM” during startup along with an error code. 	<ul style="list-style-type: none"> • A circuit fault has occurred on one of the PCB’s. 	<ol style="list-style-type: none"> 1. If the error code is 031, indicating a FLASH memory failure, press and release the RESET SILENCE button to continue to measuring mode keeping in mind that there will be no datalogging function. 2. If the error code is anything else, the instrument cannot be used. 3. Contact RKI Instruments, Inc. for further instruction if either 1 or 2 occur.
<ul style="list-style-type: none"> • Display indicates “FAIL CLOCK” during startup. 	<ul style="list-style-type: none"> • An internal clock failure has occurred because the date in the unit’s memory is not a valid date. 	<ol style="list-style-type: none"> 1. Enter normal operation by pressing and releasing the RESET SILENCE button to use the unit temporarily. 2. Attempt to set the date in the DATE menu item in Maintenance Mode. 3. If you cannot set the date, contact RKI Instruments, Inc. for further instruction.
<ul style="list-style-type: none"> • Heart symbol at the top of the screen becomes steadily on or disappears 	<ul style="list-style-type: none"> • A microprocessor error has occurred. 	<ul style="list-style-type: none"> • Contact RKI Instruments, Inc. for further instruction.
<ul style="list-style-type: none"> • The LCD shows abnormally high or low readings but other gas detection instruments do not. 	<ul style="list-style-type: none"> • The LEL or CO filters may need to be replaced • The Gas Tracer may need to be recalibrated. • The sensor for the affected channel(s) may need replacement. 	<ol style="list-style-type: none"> 1. If the abnormal reading is on the LEL channel, replace the LEL filter. If the abnormal reading is on the CO channel, replace the charcoal filter. 2. Recalibrate the unit. 3. If the difficulties continue, replace the sensor for the affected channel(s) and calibrate the affected channel(s). 4. If the difficulties continue, contact RKI Instruments for further instruction.

Table 8: Troubleshooting the Gas Tracer

Symptoms	Probable Causes	Recommended Action
<ul style="list-style-type: none"> • The unit indicates flow failure and does not recover when RESET SILENCE is pressed and released. 	<ul style="list-style-type: none"> • The cotton filter in the probe or filter holder is dirty and clogged. • The sample hose has a kink or obstruction. • The hydrophobic filter disks or wire mesh disk are dirty and clogged. • The pump is malfunctioning. 	<ol style="list-style-type: none"> 1. Change the cotton filter in the probe or filter holder. 2. Inspect the sample hose for kinks or obstructions and replace if necessary. 3. Inspect the hydrophobic filter disks and the wire mesh disk and replace if necessary. 4. Perform a low flow setpoint adjustment. For instructions, see “Performing a Low Flow Setpoint Adjustment” on page 168. 5. If difficulties continue, contact RKI Instruments for further instruction.
<ul style="list-style-type: none"> • Auto calibration fails or unable to set the response readings during single calibration. 	<ul style="list-style-type: none"> • The auto calibration values may not match the cylinder gas concentrations (auto calibration only). • The CO filter is saturated. • The sample gas is not reaching the sensor because of a bad connection. • The calibration cylinder may be out of gas or is outdated. • The sensor for the affected channel(s) may need replacement. 	<ol style="list-style-type: none"> 1. Check all calibration tubing for leaks or for any bad connections. 2. Make sure the Gas Tracer has been properly set up for calibration. 3. Change the CO filter. 4. Verify that the calibration cylinder contains an adequate supply of fresh test sample. 5. If the fail condition continues, replace the sensor(s). 6. If the difficulties continue, contact RKI Instruments, Inc. for further instruction.

Replacing or Recharging the Batteries

WARNING: To prevent ignition of a hazardous atmosphere, batteries must only be changed in an area known to be nonhazardous.

Replace the batteries when the battery icon indicates that the unit is in low battery warning. When in low battery warning, the lowest battery level indication bar is displayed in the battery icon on the LCD, and it will be flashing.

Replacing Alkaline Batteries

1. Turn off the Gas Tracer.

WARNING: Do not remove the batteries while the Gas Tracer is on.

2. Turn the battery cover release knob counterclockwise, remove the battery cover, and lay it aside.
3. Carefully remove the old alkaline batteries. Verify that the battery compartment and electrical contacts are clean.
4. Carefully install the new AA alkaline batteries according to the battery diagram inside the battery compartment.

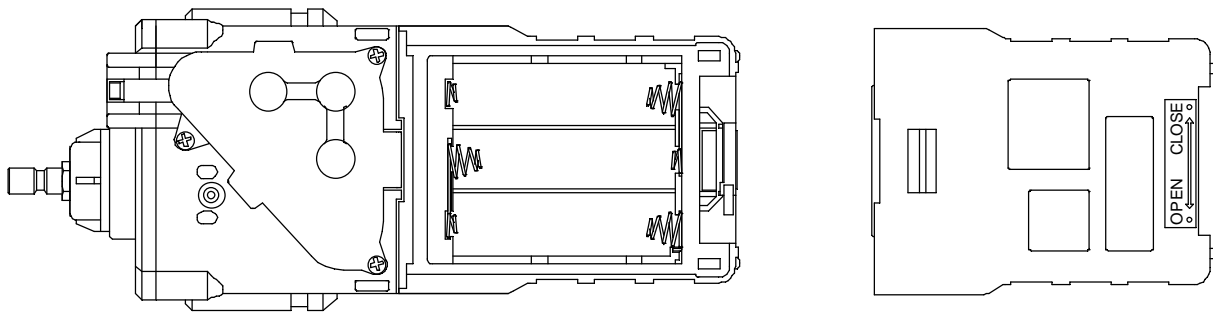

Figure 19: Installing the Alkaline Batteries

5. Reinstall the battery cover and turn the battery cover release knob clockwise to lock the cover in place.

Replacing the Lithium Ion Battery Pack

NOTE: Use RKI Instruments lithium ion battery pack 49-1615RK.

1. Turn off the Gas Tracer.

WARNING: *Do not remove the battery pack while the Gas Tracer is on.*

2. Push the latch on the bottom of the Gas Tracer toward the front of the instrument to release the battery pack.

Slide Latch This Way

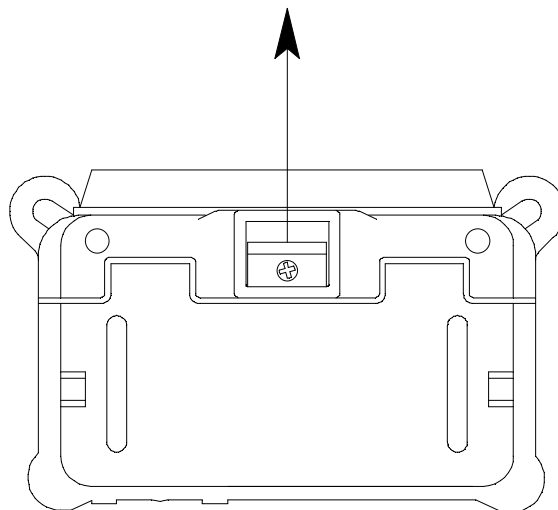

Figure 20: Releasing the Battery Pack

3. Slide the battery pack away from the instrument.
4. Insert a new battery pack ensuring that the slots and grooves on the sides are properly lined up. Push the battery pack into the instrument until you hear a click.

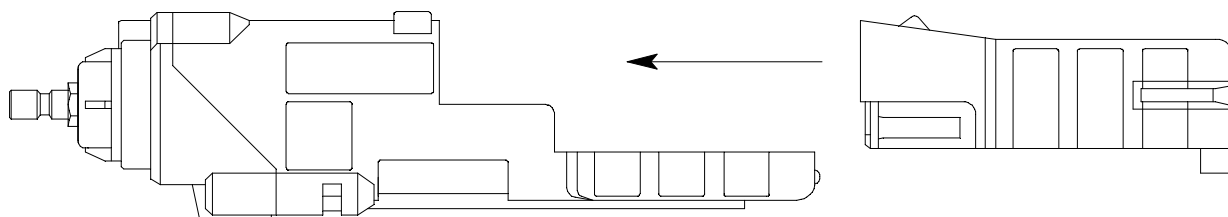
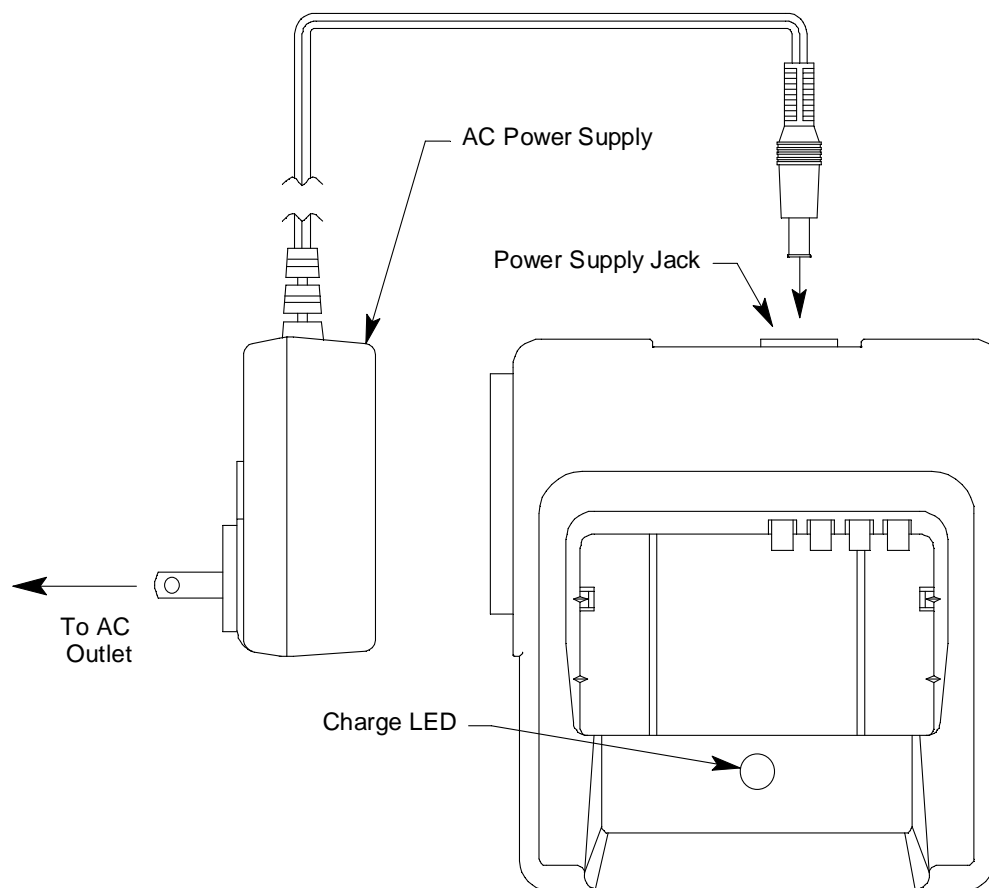

Figure 21: Installing the Battery Pack

Recharging the Lithium Ion Battery Pack in the Instrument

CAUTION: To be used only with lithium ion battery pack p/n 49-1615RK. Charge only with RKI charger model BC-2012, p/n 49-2180RK, or RKI charger model BC-2012DC, p/n 49-2181RK. Use of other rechargeable batteries or chargers or charging of other rechargeable batteries in the Gas Tracer will void the warranty.

1. Make sure the Gas Tracer is off.
2. Confirm that the adapter's DC output cord is plugged into the charger.
3. If using an AC powered charging station, plug the AC adapter into an electrical outlet.



AC Powered Charging Station

Figure 22: Connecting the Charging Station's AC Adapter

If using a DC powered charging station, plug the 12 VDC vehicle plug adapter into a vehicle's 12 VDC power socket.

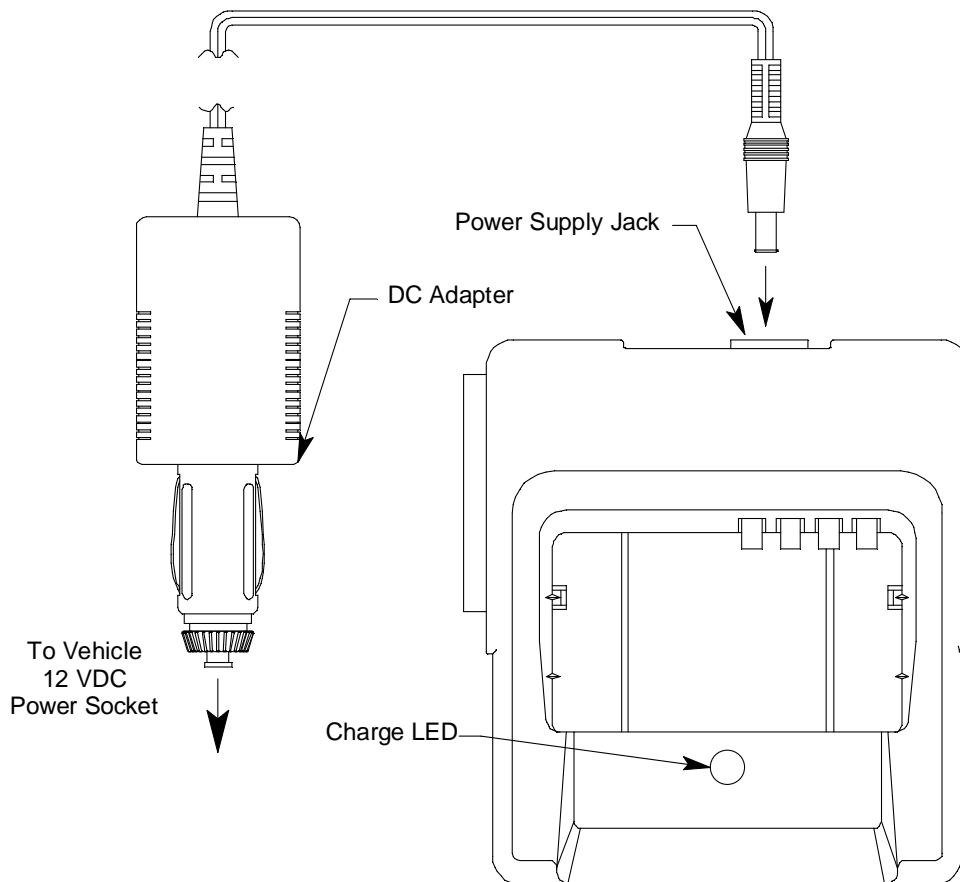

DC Powered Charging Station

Figure 23: Connecting the Charging Station's DC Adapter

The construction of the charging stations allows them to be chained together but a separate adapter must be used for each charging station. One adapter will not operate more than one charging station.

4. Place the Gas Tracer into the battery charging station as shown in Figure 24 below so that the metal contacts on the back of the unit come into contact with the metal contacts on the back of the holder in the charging station. When proper contact has been made, the red LED on the charging station will turn on.

If you are using a DC adapter, the charging station comes with a velcro strap to secure the Gas Tracer. Ensure that both ends of the velcro strap are attached to the charging station and that it is securing the instrument.

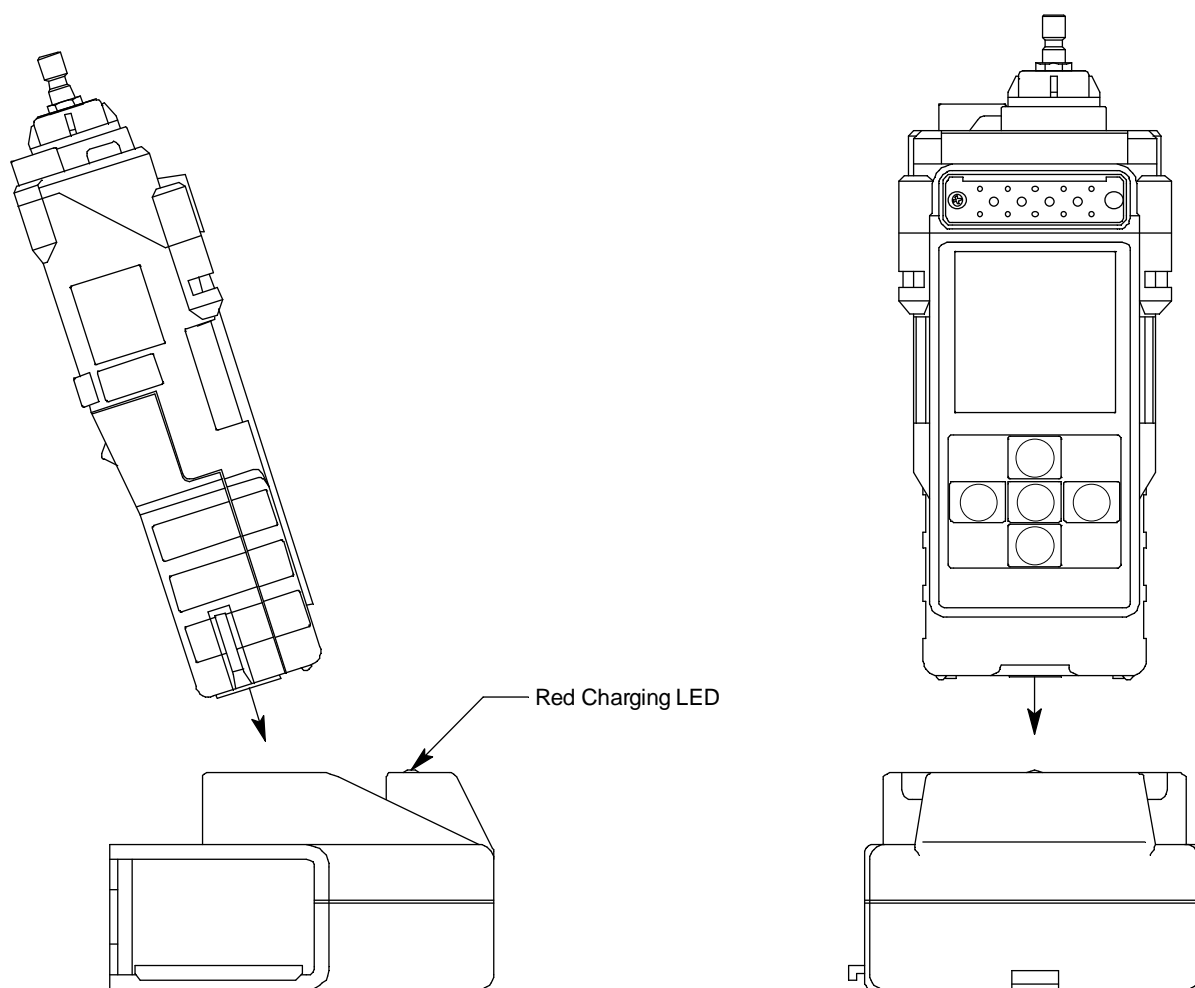

Figure 24: Putting the Gas Tracer into the Charging Station

5. When a full charge has been reached, approximately 4 hours, the red LED on the charging station will turn off. Remove the Gas Tracer from the charging station and unplug the charging station's power cord from the AC outlet.

Recharging the Lithium Ion Battery Pack Out of the Instrument

The lithium ion battery pack may be charged using the charging station while it is out of the Gas Tracer. This is useful if spare battery packs are kept in case the pack in the Gas Tracer needs to be charged, but the unit must be used immediately. In this case, a spare charged pack can be installed in the Gas Tracer and the dead pack charged in the charging station.

1. Make sure the Gas Tracer is off.
2. Confirm that the adapter's DC output cord is plugged into the charger.

3. If using an AC powered charging station, plug the AC adapter into an electrical outlet.

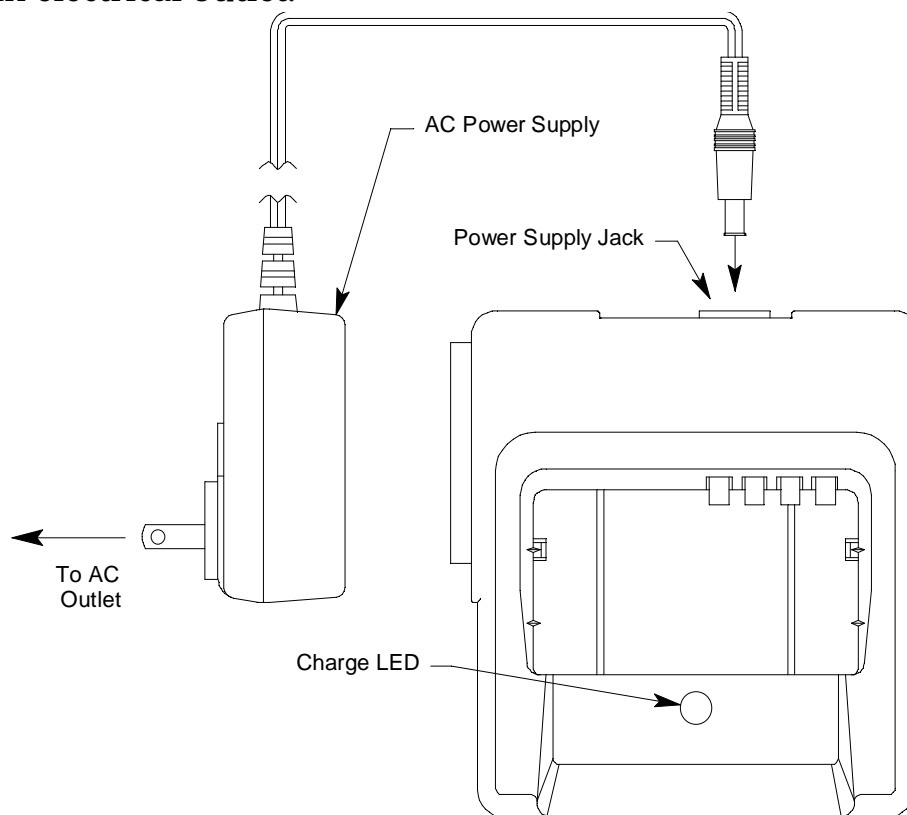

AC Powered Charging Station

Figure 25: Connecting the Charging Station's AC Adapter

If using a DC powered charging station, plug the 12 VDC vehicle plug adapter into a vehicle's 12 VDC power socket.

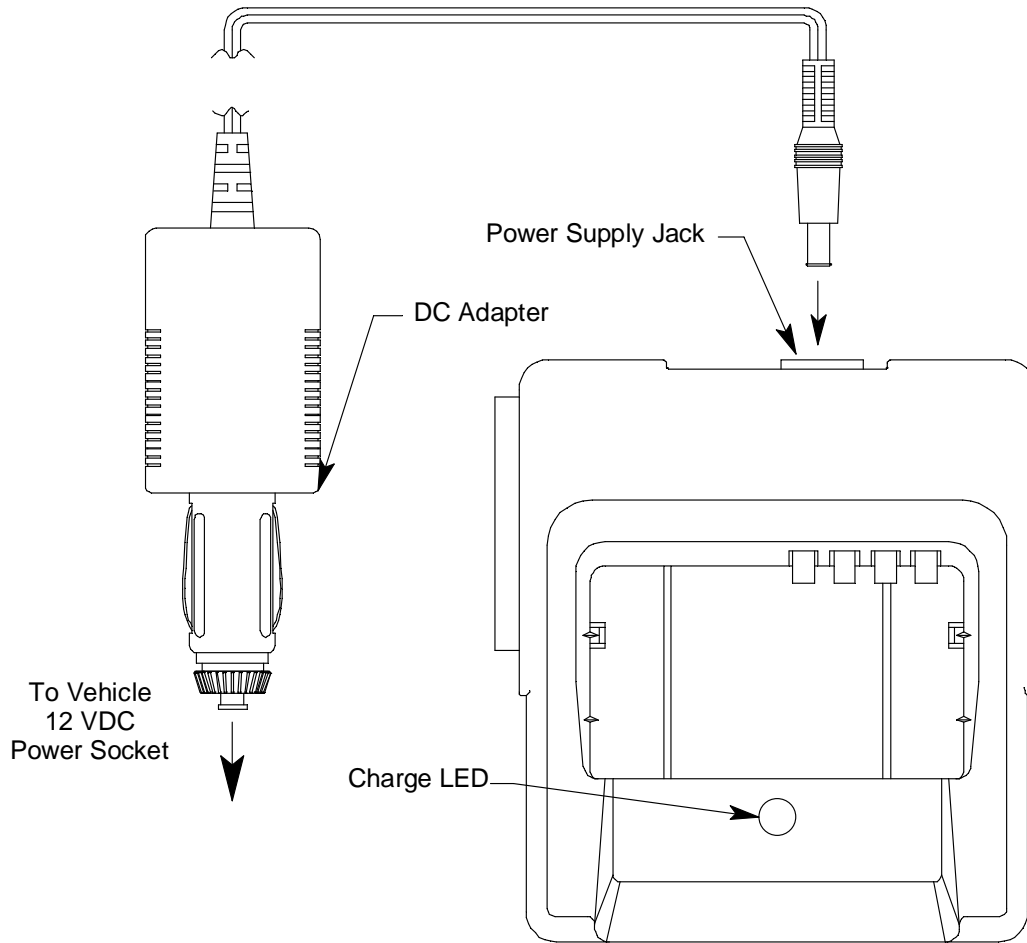

DC Powered Charging Station

Figure 26: Connecting the Charging Station's DC Adapter

The construction of the charging stations allows them to be chained together but a separate adapter must be used for each charging station. One adapter will not operate more than one charging station.

4. Insert the battery pack into the charging station as shown in Figure 27 below so that the metal contacts on the back of the battery pack come into contact with the metal contacts in the charging station. When proper contact has been made, the red LED on the charging station will turn on.

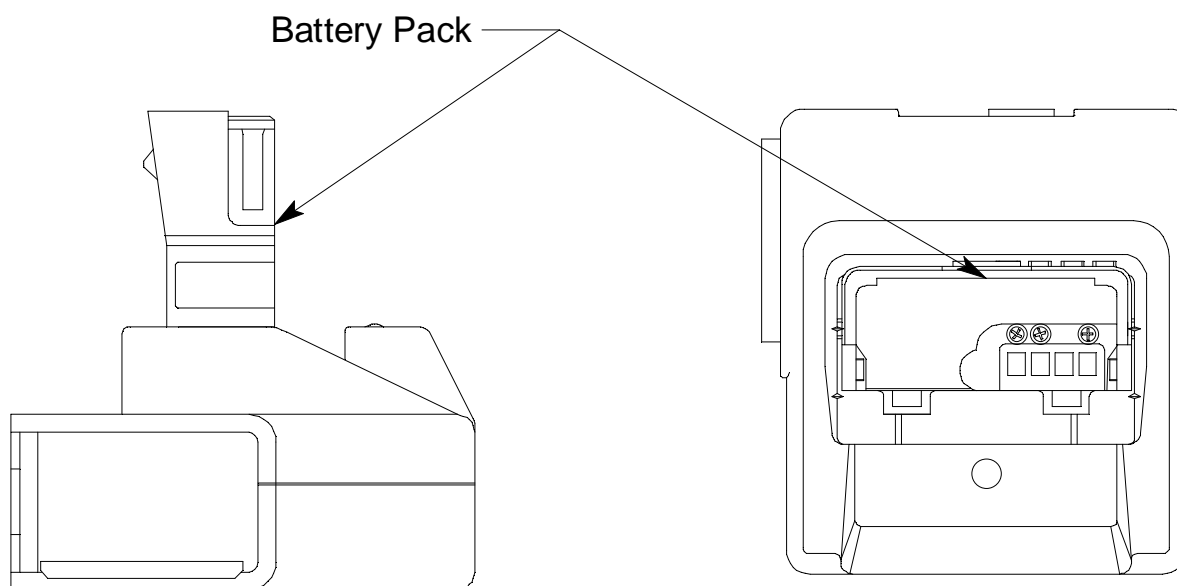

Figure 27: Putting the Battery Pack into the Charging Station

5. When a full charge has been reached, approximately 4 hours, the red LED on the charging station will turn off. Remove the battery pack from the charging station and unplug the charging station's power cord from the AC outlet.

Replacing the LEL and CO Filters

The H₂S filter disk is dark red in color and although it may darken over time, its color is not indicative of remaining filter life. The H₂S filter disk can absorb H₂S for 33 ppm hours and should be replaced after that much exposure. With this many ppm hours of absorption, the H₂S filter disk should be replaced after 80 minutes of exposure to 25 ppm H₂S. This equates to replacing the H₂S filter disk after 40 2-minute calibrations with a cylinder containing 25 ppm H₂S. If H₂S exists in the monitoring environment, the H₂S filter disk will have to be replaced more frequently.

1. Verify that the Gas Tracer is off.
2. Use a screwdriver to remove the three screws holding the belt clip to the back side of the instrument. Two of these screws also secure

the flow chamber.

3. Remove the belt clip and unscrew the remaining screw holding in the flow chamber.
4. Grab the exhaust tube and pull it gently away from the unit to slide the flow chamber out of the unit. The CO (charcoal) filter may come out.
5. To replace the LEL filter, remove the old one from its recess in the sensor gasket and replace it with the new one making sure that it is properly seated. You do not have to remove the sensor gasket to replace the LEL filter. It sits in a recess on top of it.
6. To replace the CO filter, pull the old one out of its recess in the sensor gasket if it did not already come out and replace it with a new one. You do not have to remove the sensor gasket to do this. The CO filter sits in a recess on top of it.

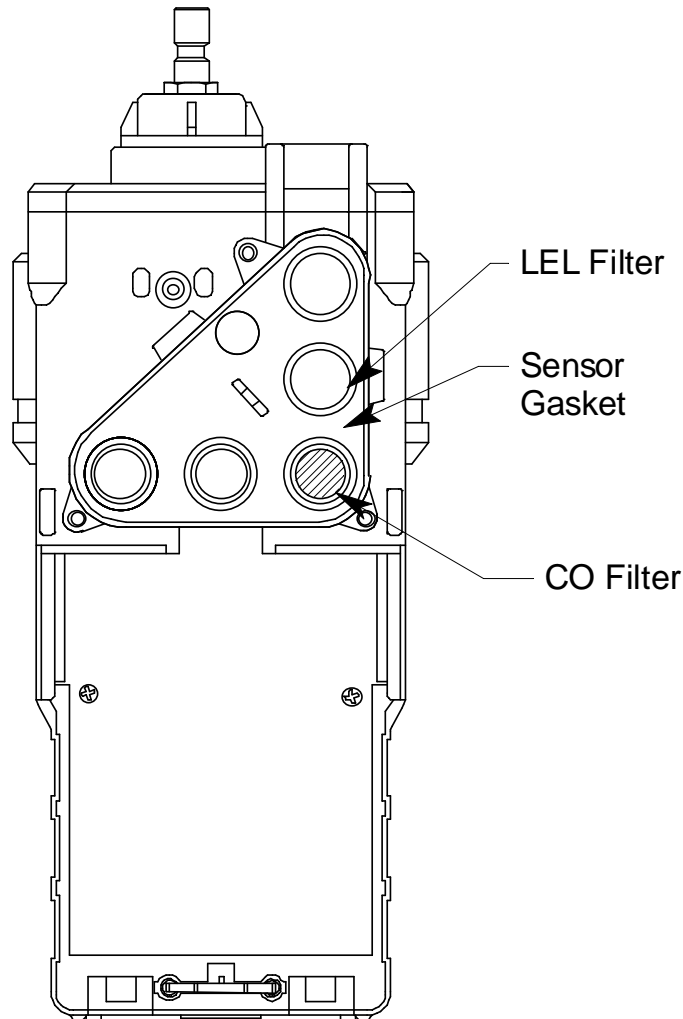

Figure 28: Replacing the LEL and CO Filters

7. Insert the flow chamber back into the instrument.

8. Tighten the top screw of the flow chamber completely.
 9. Place the belt clip into position and tighten the three screws retaining it.
-

Replacing a Sensor

1. Verify that the Gas Tracer is off.
2. Use a screwdriver to remove the three screws holding the belt clip to the back side of the instrument. Two of these screws also secure the flow chamber.
3. Remove the belt clip and unscrew the remaining screw holding in the flow chamber.
4. Grab the exhaust tube and pull it gently away from the unit to slide the flow chamber out of the unit.
5. Gently pull on the knob of the sensor gasket to remove it. Be sure not to lose any of the filters that are in it. The sensors will be exposed.
6. Remove the sensor from its socket.

7. Carefully insert the replacement sensor in the correct socket.

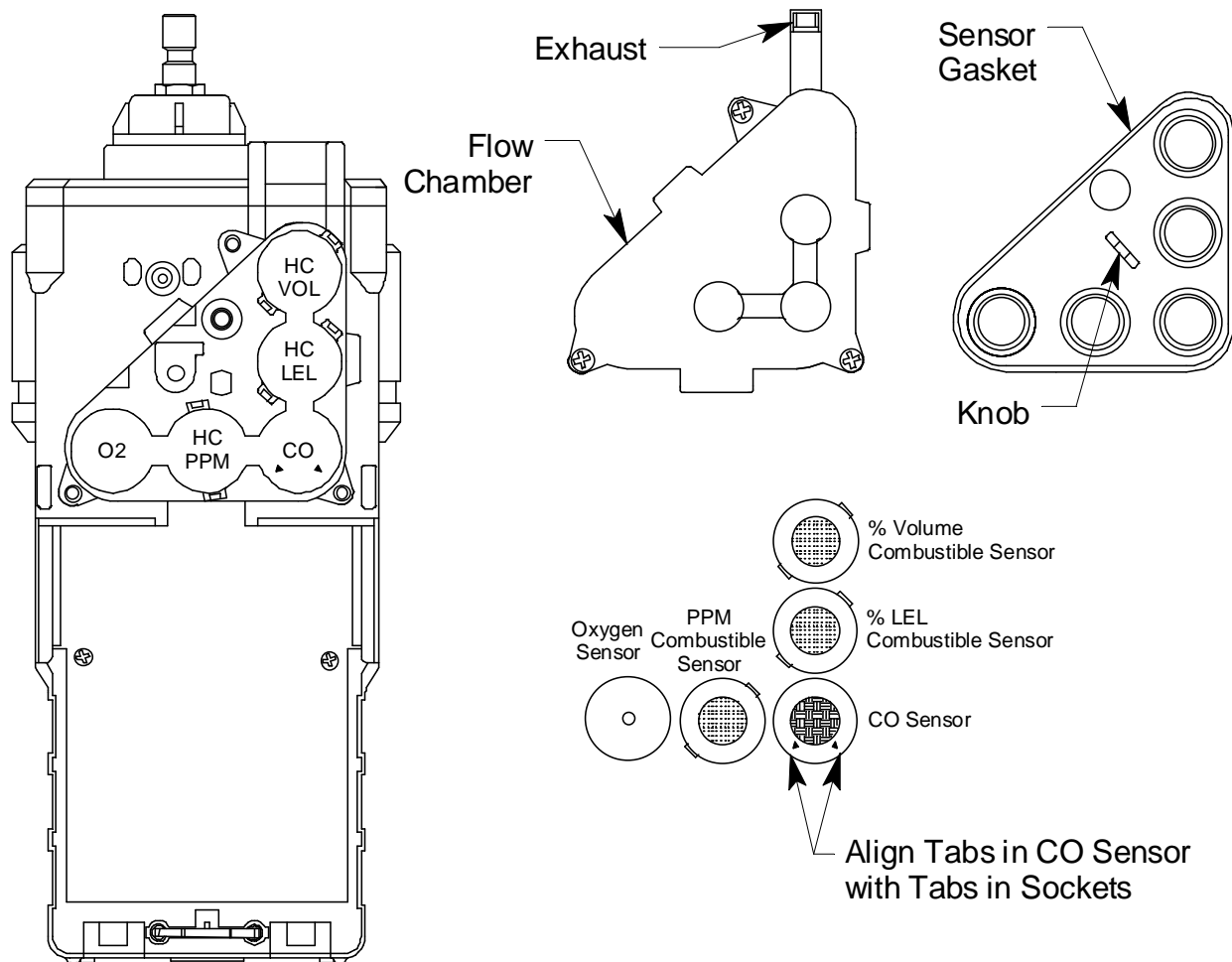

Figure 29: Replacing a Sensor

CAUTION: When replacing a sensor, verify that the sensor is properly aligned with its socket before inserting it into the socket. The CO sensor has alignment slots which match up with alignment tabs in the socket. The combustible sensors each have two non-polarized contacts which must line up with the contacts in their socket. Forcing a sensor into its socket may damage the sensor or the socket.

8. If a dummy sensor is installed, be sure that it is installed correctly. Make sure the flat side is up and the hollow side is down.
9. Place the sensor gasket and filters back into the chamber ensuring that it seals with the sensors and the edge of the chamber.
10. Place the flow chamber in position over the sensor area and press it into the case until it is flush with the back of the case.
11. Tighten the top screw of the flow chamber completely.

12. Place the belt clip into position and tighten the three screws retaining it.
13. Start up the Gas Tracer by pressing and briefly holding the POWER ENTER button.
14. Calibrate the new sensor as described in “Calibration Mode” on page 61.

Replacing the Hydrophobic Disk Filter, Cotton Filter, and Wire Mesh Disk

1. Verify that the Gas Tracer is off.
2. Locate the clear plastic filter holder at the top of the Gas Tracer.
3. Grasp the filter holder and turn it 1/4 turn counterclockwise.
4. Pull the filter holder away from the case. Inspect the cotton dust filter and replace if dirty.
5. The hydrophobic disk filters and wire mesh disk are located in the case and are retained by a rubber gasket. Pull out the rubber gasket with needle nose pliers.

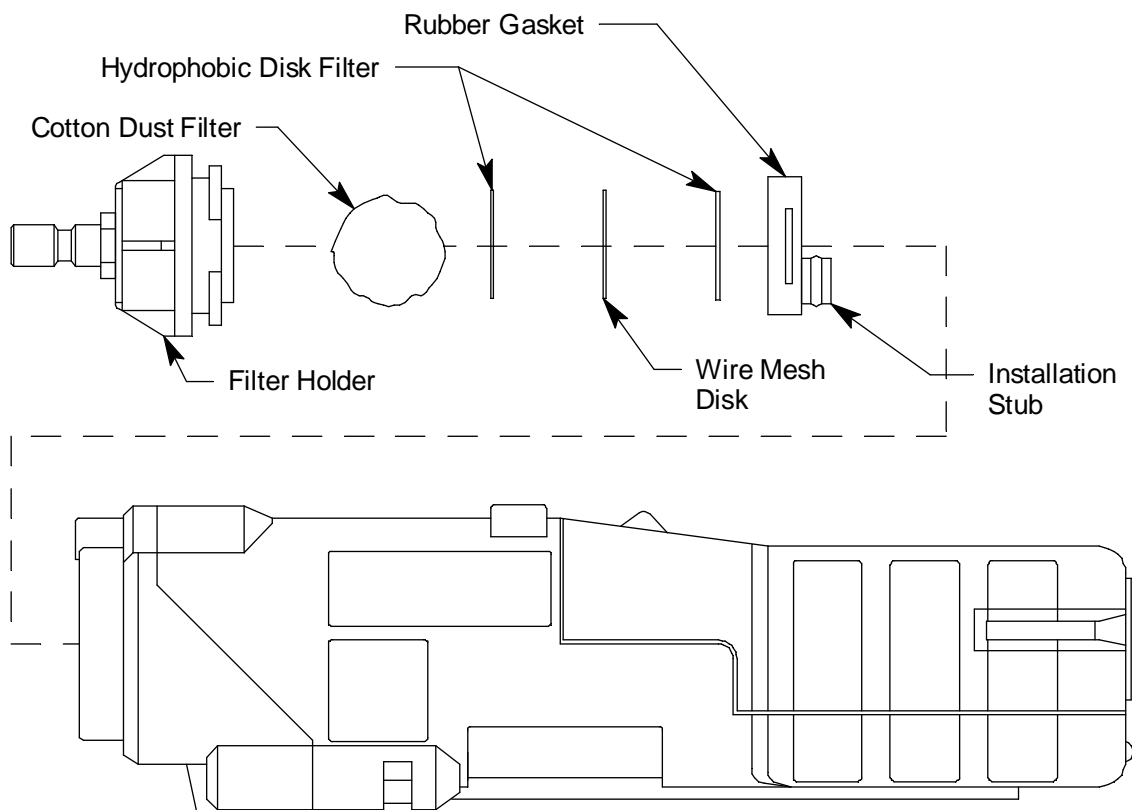

Figure 30: Changing the Filters & Wire Mesh Disk

6. Remove the old hydrophobic filters and/or wire mesh disk from

the gasket. A hydrophobic filter is located on either side of the wire mesh disk.

7. Install the new hydrophobic filters and/or wire mesh disk making sure a hydrophobic filter is located on each side of the wire mesh disk.
8. Reinstall the gasket with the parts into the case. Ensure that the installation stub is lined up with the pump intake in the filter chamber.
9. Reinstall the filter holder with the cotton dust filter. Align the two wide tabs on the bottom of the filter holder with the two wide slots in the case where the filter holder fits. Push the filter holder into the case and turn it 1/4 turn clockwise until it snaps into place.

Parts List

Table 9 lists part numbers for the Gas Tracer's replacement parts and accessories.

Table 9: Parts List

Part Number	Description
06-1248RK-03	Calibration kit tubing, 3 foot length
07-2005RK	Gasket, filter/screen retaining
13-0112RK	Wrist strap
17-1001RK	Tapered rubber nozzle
17-4430RK-01	Purge tee fitting
21-1833RK	Filter holder, clear plastic
33-0159RK	Hydrophobic disk filter
33-1031RK	Cotton ball 25 pack, for replacement of cotton dust filter
33-1112RK	Wire mesh disk filter
33-2001RK-01	6 inch humidifier tube, for connecting ppm calibration cylinder to instrument
33-7102RK	Charcoal filter disk, 5 pack, for CO sensor
33-7114RK	Filter disk, H ₂ S scrubber, 5 pack, for LEL sensor
47-5084RK	USB/IrDA adapter module (without USB cable)
47-5084RK-01	USB/IrDA adapter assembly (with module and USB cable)
47-5085RK	Cable, USB A to USB mini, 6 feet, for USB/IrDA adapter module
49-0115RK	AC adapter for charging station
49-1615RK	Lithium ion battery pack
49-1616RK	Alkaline battery pack without batteries
49-1616RK-01	Battery cover, alkaline battery pack
49-1616RK-02	Battery base, without cover, alkaline battery pack
49-1120RK	AA size alkaline battery
49-2020RK	DC adapter for charging station
49-2180RK	Charging station only, no AC adapter
49-2180RK-01	Charging station with AC adapter, 110/115/220 VAC
49-2181RK	Charging station with 12 VDC vehicle plug adapter
71-0244RK	Operator's Manual, Model Gas Tracer (this document)

Table 9: Parts List (cont.)

Part Number	Description
71-0245RK	Operator's Manual, GX-2012 Data Logger Management Program
71-8005RK	Gas Tracer Product CD
80-0009RK-XX	Sample hose. Replace "XX" with length in feet. Available lengths for the GX-2012 are 2, 3, 10, 15, 20, 25, 30, 40, and 50 feet.
80-0101RK	8 meter hose with floating head
80-0140RK	32" telescoping probe with dust filter
80-0144RK	7' telescoping probe with dust filter
80-0150RK	10" sample probe with dust filter
80-0155RK	30" aluminum probe
80-0157RK	30" fiberglass bar hole probe
80-0225RK	Hydrophobic filter
80-0404RK	1:1 dilution fitting
81-GT51-DLV	Calibration kit, ppm only, includes 34 liter 500 ppm CH ₄ in air cylinder, demand flow regulator, case, and tubing
81-GT64-DLV	Calibration kit, for standard Gas Tracer (ppm/LEL/Oxy/CO), includes 34 liter 500 ppm CH ₄ in air cylinder, 34 liter 3-gas cylinder (CH ₄ ; O ₂ ; CO), demand flow regulator, case, and tubing
81-GT69	Calibration kit, for %volume Gas Tracer (ppm/LEL/%vol/Oxy/CO), includes 103 liter 500 ppm CH ₄ in air cylinder, 58 liter 100% vol CH ₄ cylinder, 103 liter 3-gas cylinder (CH ₄ ; O ₂ ; CO), demand flow regulator, case, and tubing
81-0012RK-01	Calibration cylinder, 50% LEL methane in air, 34 liter
81-0012RK-03	Calibration cylinder, 50% LEL methane in air, 103 liter
81-0016RK-05	Calibration cylinder, 100% volume methane in nitrogen, 58 liter
81-0018RK-01	Calibration cylinder, 50% LEL isobutane in air, 34 liter
81-0018RK-03	Calibration cylinder, 50% LEL isobutane in air, 103 liter
81-0026RK-01	Calibration cylinder, 250 ppm isobutane in air, 34 liter
81-0026RK-03	Calibration cylinder, 250 ppm isobutane in air, 103 liter
81-0079RK-01	Calibration cylinder, 500 ppm CH ₄ in air, 34 liter
81-0079RK-03	Calibration cylinder, 500 ppm CH ₄ in air, 103 liter
81-0090RK-01	Calibration cylinder for demand-flow regulator kit, 34L steel; three-gas (CH ₄ ; O ₂ ; CO)

Table 9: Parts List (cont.)

Part Number	Description
81-0090RK-03	Calibration cylinder for demand-flow regulator kit, 103L; three-gas (CH ₄ ; O ₂ ; CO)
81-1054RK	Regulator, demand-flow type (for 34-liter aluminum and 58- and 103-liter calibration cylinders)
81-1055RK	Regulator, demand-flow type (for 17- and 34-liter steel calibration cylinders)
ES-1821	Carbon monoxide sensor
ES-1827i	Hydrogen sulfide sensor
NC-6264A	% LEL combustibles sensor
OS-BM2	Oxygen sensor
SH-8641	PPM combustible sensor, catalytic/MOS type
TE-7561	TC %volume combustibles sensor

Appendix A: Calibrating or Bump Testing with a Sample Bag

Overview

The Gas Tracer can be calibrated or bump tested with a gas bag calibration kit instead of a demand flow regulator kit. Appendix A describes how to use a sample bag calibration kit to calibrate and bump test the Gas Tracer. A parts list at the end of this appendix lists spare parts for the calibration kit.

Calibration/Bump Test Supplies and Equipment

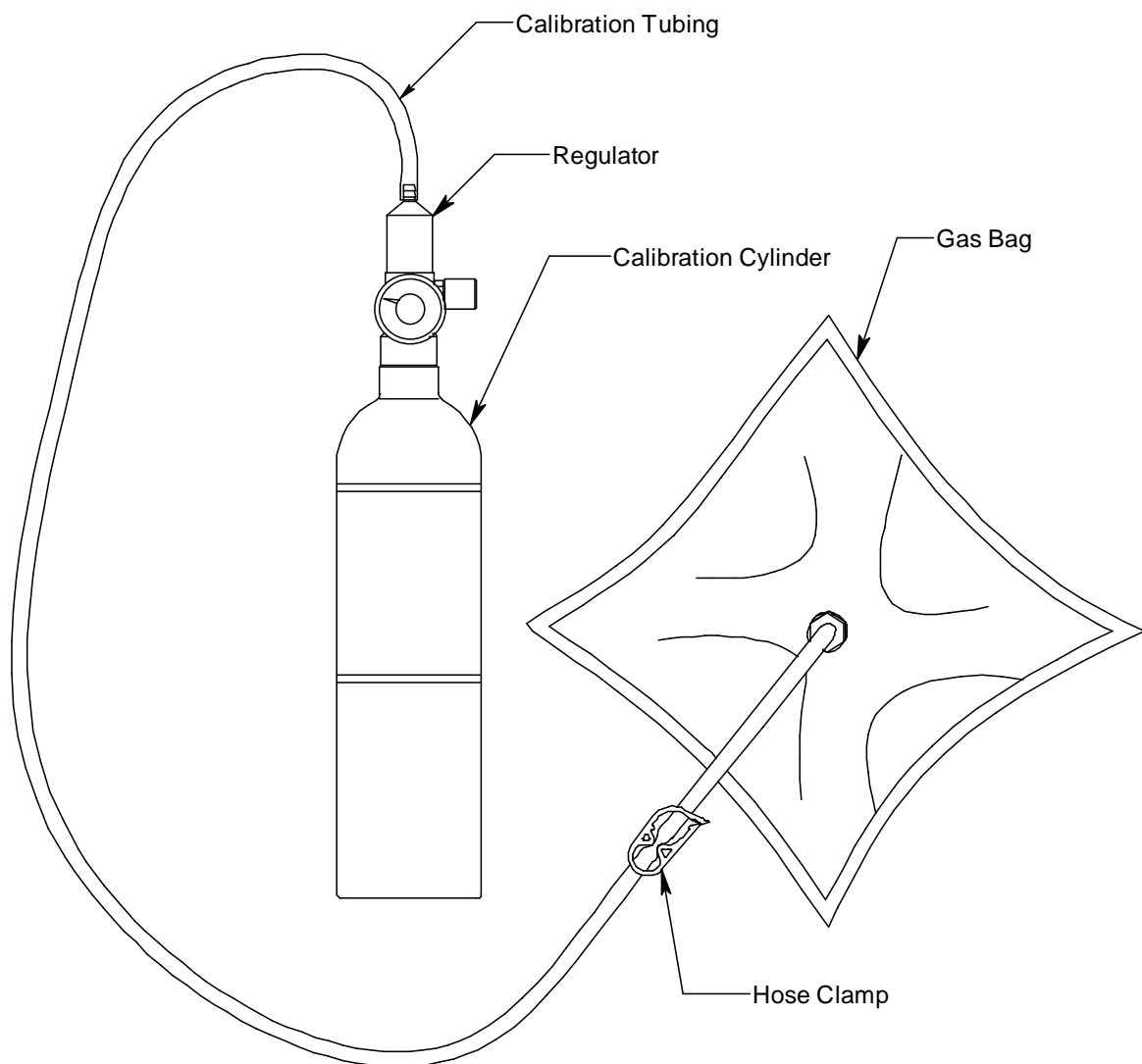

Figure 31: Gas Bag Calibration Kit

To calibrate or bump test the Gas Tracer, you will need:

- Known calibrating samples of the gases being detected. The combustible and toxic gas samples should have concentrations in approximately the middle of the range of detection. An oxygen-free source, such as 100% nitrogen is recommended for setting the oxygen zero when using single calibration.

WARNING: When using auto calibration, the multi-gas cylinder must have an oxygen concentration in the range of 10% - 18% oxygen.

- A gas collection bag with hose clamp
- A 0.5 LPM fixed-flow regulator or dispensing valve
- Non-absorbent tubing
- 6 inch humidifier tube (for ppm calibration)

To calibrate the %LEL, Oxygen, and CO sensors at the same time, automatically, with no need for a zero-oxygen source, you can use the auto calibration feature with a 3-gas cylinder. This appendix includes instructions for auto calibration with a fixed flow regulator or dispensing valve, a 3-gas cylinder, and a %volume methane cylinder. This document also includes instructions for calibrating one channel at a time using single calibration.

NOTE: If the combustible gas channels are calibrated to a gas other than methane, use an appropriate multigas cylinder or use single calibration to calibrate the combustible channels.

Preparing for Calibration or Bump Testing

Perform the following tasks prior to performing a calibration or a bump test.

Normal Operation Fresh Air Adjustment

Whether you will perform an auto calibration, a single calibration, or a bump test on the Gas Tracer, you will need to set the fresh air readings first before setting the span readings for each gas.

1. Find a fresh-air environment. This is an environment free of toxic or combustible gases and of normal oxygen content (20.9%).
2. Turn on the unit as described in “Turning On the Gas Tracer,

Normal Mode Only” on page 20 or “Turning On the Gas Tracer in Normal Mode With All Modes Active” on page 26. Use the sample hose and probe.

3. With the unit on, perform a fresh air adjustment by pressing and holding the AIR▲ button. The display prompts you to hold the AIR▲ button.

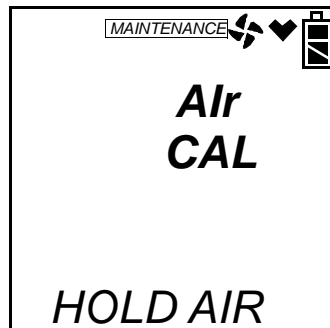

4. Continue to hold the AIR▲ button until the display prompts you to release it. The Gas Tracer will count down from 8 as it sets the fresh air reading for all channels. If the combustible channel is set as %LEL only or vol% only, there is no countdown period. The fresh air reading is set immediately.

Filling the Gas Bag

Use the following procedure to fill the gas bag with calibration gas.

1. Slide the tubing clamp onto the tubing and connect the tubing onto the sample bag's inlet. Leave the clamp unclamped for now.
2. Connect the other end of the tubing to the regulator's or dispensing valve's hose barb fitting.

NOTE: If you are filling the gas bag with ppm calibration gas, do not use the 6 inch humidifier tube at this point.

3. Fill the gas collection bag by screwing the fixed flow regulator onto the calibration cylinder or by screwing the dispensing valve onto the calibration cylinder and turning the knob counterclockwise.

NOTE: If the regulator has no on/off knob, then gas will begin to flow at 0.5 LPM as soon as the regulator is connected to the cylinder.

4. Allow the gas to dispense until the gas collection bag is a little over half full.
5. If a fixed flow regulator without a knob is used, disconnect it from the cylinder and immediately clamp down the hose clamp to

prevent the release of gas from the gas collection bag. If a fixed flow regulator with a knob or a dispensing valve is used, turn the knob clockwise to stop the gas flow, clamp down the hose clamp and remove the regulator or dispensing valve from the cylinder.

6. Disconnect the tubing from the regulator or dispensing valve.

Calibrating the Gas Tracer

From Measuring Mode, enter Calibration Mode by pressing and holding the (SHIFT)▼ button, then pressing the DISPLAY(ADJ) button and releasing both. If the unit prompts you for the password, enter it by using the AIR▲ and (SHIFT)▼ buttons to select each password number and then pressing and releasing POWER ENTER to confirm it and move on to the next number. To go back a number, press and release the RESET SILENCE button. The factory set password is the same as the factory set password for Maintenance Mode: 2102. You can change the password by entering the **PASSWORD** menu item in Maintenance Mode. See “Turning the Password Function On or Off” on page 167. If you enter an incorrect password, an error screen will display.

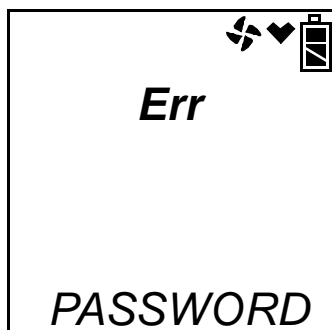

To return to normal operation, press and release the RESET SILENCE button. You may then try to reenter Calibration Mode.

MAINTENANCE will appear along the top of the screen once you have entered Calibration Mode. The first item in the calibration menu, AIR CAL, displays.

NOTE: The following screens illustrate a three-gas Gas Tracer with a %LEL and a %volume combustible sensor as examples only. Your Gas Tracer may display slightly different screens.



The Gas Tracer's calibration menu includes two methods of calibration:

- **Auto Calibration:** This method allows you to calibrate the combustible gas (%LEL sensor only), OXY, and CO sensors simultaneously. It is designed for use with the RKI 3-gas calibration cylinder and is the quickest and easiest method to calibrate the Gas Tracer. If installed, you may also calibrate the %volume sensor separately from the standard three.
- **Single Calibration:** This method allows you to calibrate one sensor at a time. Use this method if you are only calibrating one or two sensors, if you are calibrating only the %volume combustible sensor, or if you are not using the RKI 3-gas calibration cylinder.

NOTE: These methods only apply to the standard 3 sensors and the vol% sensor (if installed). The PPM sensor must be calibrated independently using PPM CAL. See “Calibrating and Bump Testing the PPM Combustible Sensor” on page 207 for instructions.

Calibrating with the Auto Calibration Method

This section describes calibration using the auto calibration method. To calibrate using the single calibration method, see “Calibrating with the Single Calibration Method” on page 197.

NOTE: If the combustible gas channels are calibrated to a gas other than methane, use an appropriate multigas cylinder to fill the gas bag or use single calibration to calibrate the combustible channels.

1. You may only calibrate either the standard 3 sensors or the %volume combustible gas sensor at a time. Once you are finished,

you are returned to the initial AUTO CAL screen and must begin the auto calibration process again.

2. Fill the gas bag with calibration gas as described in “Filling the Gas Bag” on page 191.
3. Use the AIR▲ and (SHIFT)▼ buttons to scroll to the **AUTO CAL** menu item. Press and release the POWER ENTER button to display the calibration values screen. If you want to exit back to the main menu without completing a calibration, press and release the DISPLAY (ADJ) button.
4. Use the AIR▲ or (SHIFT)▼ buttons to scroll between the 3-gas and the %volume combustible gas calibration values screens.

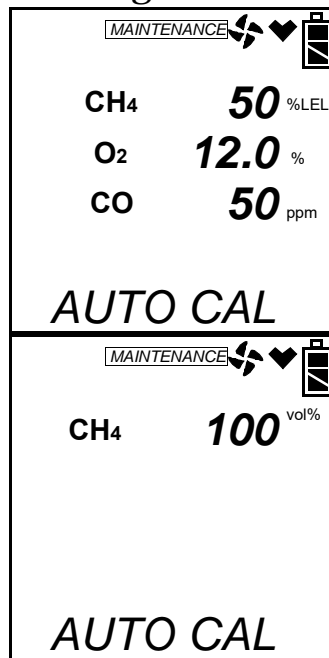

5. The gas concentrations displayed in the calibration values screens must match the gas concentrations listed on the calibration cylinders. If *all* concentrations match, go to step 13. If *one or more* concentrations do not match, continue with step 6.

6. To adjust the values on the screen, hold down the (SHIFT)▼ button, then press the DISPLAY(ADJ) button and release both. The %LEL sensor is shown.

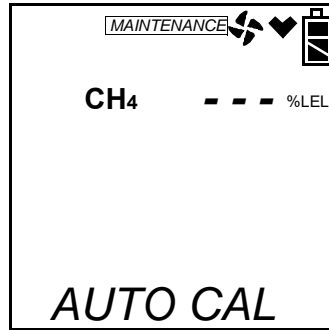

7. Use the AIR▲ and (SHIFT)▼ buttons to scroll through the sensors and select the sensor whose calibration gas value you want to adjust.
8. Press and release the POWER ENTER button. The sensor's calibration gas value will flash.
9. If necessary, use the AIR▲ and (SHIFT)▼ buttons to set the correct calibration gas value.
10. Press and release the POWER ENTER button to save the change.
11. Repeat steps 7 through 10 to set the correct values for any additional sensors.
12. After the last calibration gas value is set, use the AIR▲ button to scroll to ESCAPE and press POWER ENTER to return to the calibration gas values screens.

NOTE: The RKI Three Gas Cylinder typically contains 12% O₂ by volume. Be sure to set the "OXY" reading to agree with the concentration listed on the cylinder's label, not zero.

13. Use the AIR▲ and (SHIFT)▼ button to select which sensor(s) you want to calibrate, the standard 3 sensors or the %volume combustible gas sensor.

The following instructions illustrate calibrating the standard 3 sensors first, then the %volume combustible gas sensor.

14. With the 3-gas calibration values screen displayed, press the POWER ENTER button. AUTO CAL begins to flash and the current gas readings are displayed. If you want to exit back to the main menu without completing a calibration, press and release the DISPLAY (ADJ) button.

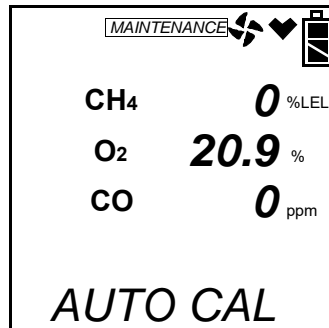

15. Open the hose clamp and connect the tubing from the filled gas bag to the rigid tube on the probe. Allow the gas to flow for one minute.
16. Press and release the POWER ENTER button to set the calibration to the programmed values.

If all channels passed calibration, PASS displays along the bottom of the screen, then the calibration menu displays.

If any of the sensors cannot calibrate to the proper value, FAIL displays along the bottom of the screen and the Gas Tracer lists the sensor(s) that failed to calibrate. In the example below, the OXY channel failed calibration. The other sensors calibrated normally.

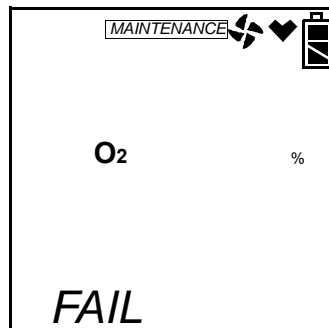

The buzzer and alarm lights activate. Press and release the RESET SILENCE button after the buzzer and lights stop to reset the alarm and return to the calibration menu. Attempt to calibrate again. If the failure continues, investigate the cause. See “Troubleshooting” on page 170.

17. Disconnect the tubing from the probe.
18. If you have a 5 sensor unit and wish to calibrate the %volume sensor, go back to step 1 and repeat the process selecting the

%volume calibration value screen.

If you are finished calibrating, use the (SHIFT)▼ button to navigate to the **NORMAL** menu item, then press and release the POWER ENTER button to return to Measuring Mode.

Calibrating with the Single Calibration Method

This section describes calibration using the Single Calibration method. To calibrate using the Auto Calibration method, see “Calibrating with the Auto Calibration Method” on page 193.

The procedure below describes a span adjustment of one channel using a calibration kit that includes a 3-gas calibration cylinder, a 0.5 LPM (liters per minute) regulator, and a gas bag. The standard 3-gas cylinder consists of 50% LEL methane, 12% oxygen, 50 ppm CO, and a balance of nitrogen. In the example below, the CH₄ channel’s span is adjusted. See “Parts List” on page 186 for available calibration kits and calibration kit spare parts.

Calibration cylinders that contain only one target gas may also be used for single calibration. For channels other than oxygen, RKI Instruments, Inc. recommends that you use a cylinder that contains a concentration of 10-50% of the full scale value of the target gas. For example, if you are calibrating the combustible gas channel, your calibration cylinder should have a combustible gas concentration between 10% LEL and 50% LEL. For the oxygen channel, RKI Instruments, Inc. recommends using 100% nitrogen to perform the adjustment but any concentration between 0% oxygen (100% nitrogen) and 17% oxygen can be used to make the adjustment.

NOTE: If your combustible gas channel is calibrated to a gas other than methane, use an appropriate gas cylinder to perform the calibration.

CAUTION: *The single calibration method does not have a “FAIL” notification. If a sensor cannot be set to agree with the calibration source, see “Troubleshooting” on page 170.*

1. While in the calibration menu, use the AIR▲ or (SHIFT) ▼ button to scroll to the ONE CAL menu option.



2. Fill the gas bag with calibration gas as described in “Filling the Gas Bag” on page 191.
3. Press and release the POWER ENTER button to display the single calibration menu. The %LEL sensor will be displayed first.

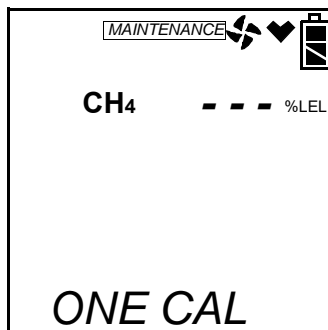

4. Use the AIR▲ or (SHIFT)▼ button to display the sensor you want to calibrate (in this example the combustible gas % LEL sensor). If you have a 5 sensor unit, the %vol sensor will be one of the choices. It is shown below.

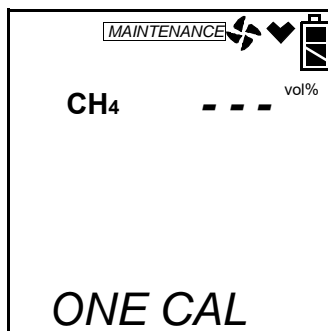

5. Press and release the POWER ENTER button. The single calibration screen displays for the sensor you selected. The gas reading flashes.

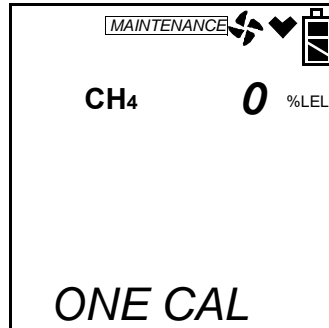

6. Connect the tubing from the filled gas bag to the rigid tube on the probe. Allow the calibration gas to flow for one minute.
7. If necessary, use the AIR▲ and (SHIFT)▼ buttons to adjust the reading to match the concentration listed on the calibration cylinder.

If the reading already matches the concentration listed on the calibration cylinder, press and release the AIR▲ button then press and release the (SHIFT)▼ button so that the instrument sees a change and resets the calibration date.

8. Press and release the POWER ENTER button to save the span value. The LCD will indicate that the calibration has ended, then the single calibration menu displays.

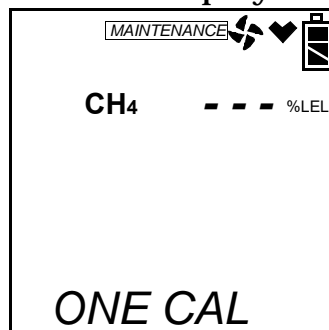

9. Disconnect the tubing from the probe.
10. Repeat steps 4 through 9 for any other sensors you want to calibrate. Make sure you use an appropriate calibration cylinder for each sensor.

CAUTION: When calibrating the oxygen channel, verify the concentration of oxygen listed on the cylinder's label. For oxygen-free samples (100% nitrogen for example), set the oxygen zero setting to 0.0%.

11. After the last channel is calibrated, disconnect the calibration tubing from the probe.
12. Use the AIR▲ and (SHIFT)▼ buttons to scroll to ESCAPE in the ONE CAL menu.
13. Press and release the POWER ENTER button to exit ONE CAL.
14. With the ONE CAL menu option displayed, press the (SHIFT)▼ button until the NORMAL menu option is displayed.
15. Press and release the POWER ENTER button to return to Measuring Mode.

Bump Testing

NOTE: The **BUMP DSP** menu item in Maintenance Mode is factory set to OFF. The **BUMP** menu item will not appear unless **BUMP DSP** is set to ON. See “Turning the Bump Test Function On or Off” on page 151 for instructions.

NOTE: The Gas Tracer uses parameters defined in the **BUMP--SET** menu item of Maintenance Mode while performing a bump test. To view or update these parameters, see “Updating the Bump Test Parameters” on page 152.

NOTE: If the combustible gas channels are calibrated to a gas other than methane, use an appropriate multigas cylinder.

From Measuring Mode, enter Calibration Mode by pressing and holding the (SHIFT)▼ button, then pressing the DISPLAY(ADJ) button and releasing both. If the unit prompts you for the password, enter it by using the AIR▲ and (SHIFT)▼ buttons to select each password number and then pressing and releasing POWER ENTER to confirm it and move on to the next number. To go back a number, press and release the RESET SILENCE button. The factory set password is the same as the factory set password for Maintenance Mode: 2102. You can change the password by entering the **PASSWORD** menu item in Maintenance Mode. See “Turning the Password Function On or Off” on page 167. If you enter an incorrect password, an error screen will display.

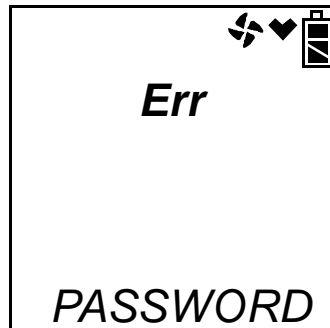

To return to normal operation, press and release the RESET SILENCE button. You may then try to reenter Calibration Mode.

MAINTENANCE will appear along the top of the screen once you have entered Calibration Mode. The first item in the calibration menu, AIR CAL, displays.

1. Fill a gas bag with calibration gas as described in “Filling the Gas Bag” on page 191.
2. Use the AIR▲ or (SHIFT)▼ buttons to display the BUMP menu item.

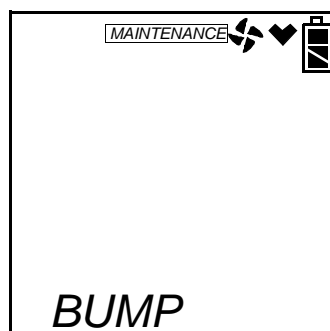

3. Press and release the POWER ENTER button to display the bump test gas values.

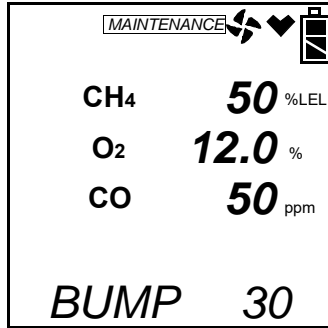

4. Use the AIR▲ or (SHIFT)▼ buttons to see the %volume combustible gas bump test value.

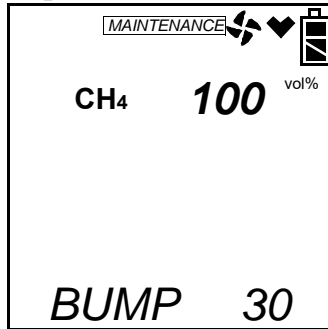

5. A bump test may be performed on the standard 3 sensors or on the %volume combustible sensor. Use the AIR▲ or (SHIFT)▼ buttons to display the screen for the sensor(s) you wish to bump test.
6. Before proceeding, confirm that the bump test gas value(s) are the same as the concentration(s) in the calibration cylinder. If they are not, adjust the bump test gas value(s) by entering the AUTO CAL menu item, changing the values there, and reentering the BUMP menu.
7. Open the hose clamp and connect the tubing from the filled gas bag to the rigid tube on the probe and quickly press and release the POWER ENTER button. The unit will begin counting down from 30.

8. When AUTO CAL in the **BUMP--SET** menu item in Maintenance Mode is set to OFF:

- The instrument will display which channels passed or failed the bump test with a P (pass) or an F (fail) to the right of the gas.

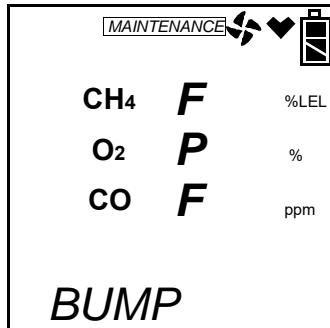

- To view the bump test gas readings press the AIR▲ or (SHIFT)▼ button. You can scroll between the bump test results and the bump test gas readings with the AIR▲ or (SHIFT)▼ button.

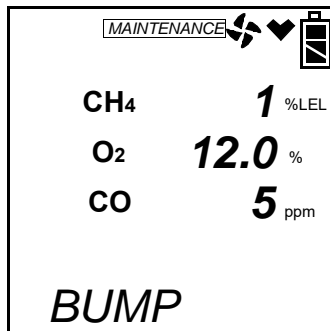

- To return to the BUMP screen in Calibration Mode, press POWER ENTER.

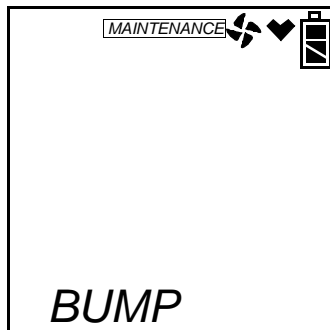

See “Troubleshooting” on page 170 to investigate the cause of the failure and replace the failed sensor or sensors if necessary.

- Disconnect the tubing from the probe.

9. When AUTO CAL in the **BUMP--SET** menu item in Maintenance Mode is set to ON:

If all channels pass the bump test,

- The following screen appears:

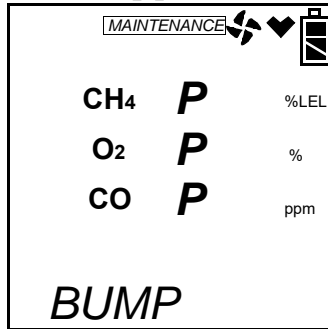

- To view the bump test gas readings press the AIR▲ or (SHIFT)▼ button. You can scroll between the bump test results and the bump test gas readings with the AIR▲ or (SHIFT)▼ button.

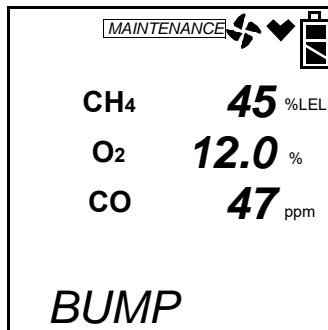

- To return to the BUMP screen in Calibration Mode, press POWER ENTER.

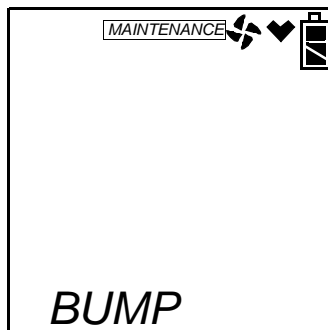

- Disconnect the tubing from the probe.

If any channel fails the bump test,

- The instrument will beep and a calibration is immediately and automatically started. Continue to apply the calibration gas. CAL on the bottom left of the screen will alternate with APPLY.

The calibration time will begin to countdown in seconds in the

lower right of the screen. The calibration time counted down during a calibration initiated because of a failed bump test is the difference between the bump test gas time and the calibration time defined in the **BUMP--SET** menu item in Maintenance Mode.

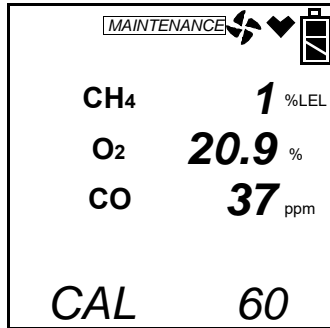

- At the end of the calibration, the instrument displays the results from both the bump test and the calibration. Use the AIR▲ or (SHIFT)▼ button to scroll between the calibration/ bump test results, the bump test gas readings, and the calibration gas readings.

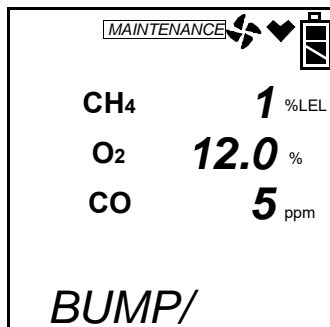
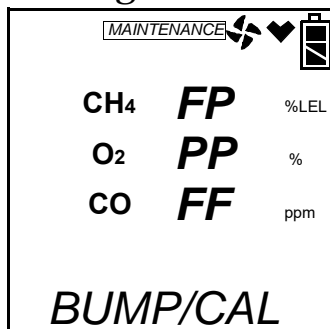

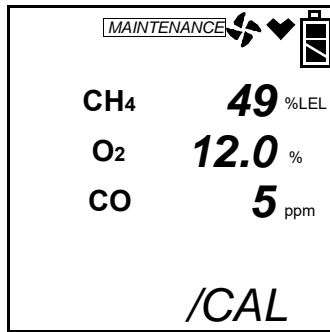

- To return to the BUMP screen in Calibration Mode, press POWER ENTER at any time. If any channel failed the calibration, the buzzer will sound a double pulsing tone until you press and release the POWER ENTER button.

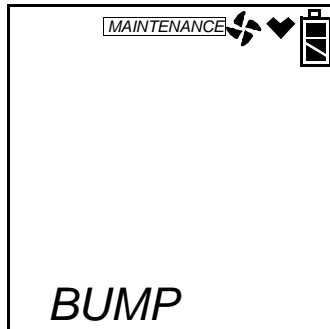

- Disconnect the tubing from the probe.
10. With the BUMP menu option displayed, press the (SHIFT)▼ button until the NORMAL menu option is displayed.
 11. Press and release the POWER ENTER button to return to Measuring Mode.

Calibrating and Bump Testing the PPM Combustible Sensor

The PPM sensor in the Gas Tracer needs to be calibrated and bump tested separately. It cannot be calibrated using the **AUTO CAL** or **ONE CAL** menu items in the main menu or bump tested using the **BUMP** menu item in the main menu. The **PPM CAL** menu item must be used. In addition, a 6 inch humidifier tube must be used to connect the ppm calibration cylinder to the instrument.

From Measuring Mode, enter Calibration Mode by pressing and holding the (SHIFT)▼ button, then pressing the DISPLAY(ADJ) button and releasing both. If the unit prompts you for the password, enter it by using the AIR▲ and (SHIFT)▼ buttons to select each password number and then pressing and releasing POWER ENTER to confirm it and move on to the next number. To go back a number, press and release the RESET SILENCE button. The factory set password is the same as the factory set password for Maintenance Mode: 2102. You can change the password by entering the **PASSWORD** menu item in Maintenance Mode. See “Turning the Password Function On or Off” on page 167. If you enter an incorrect password, an error screen will display.

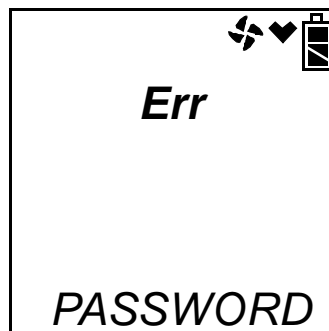

To return to normal operation, press and release the RESET SILENCE button. You may then try to reenter Calibration Mode.

MAINTENANCE will appear along the top of the screen once you have entered Calibration Mode. The first item in the calibration menu, AIR CAL, displays.

1. Use the AIR▲ or (SHIFT)▼ buttons to display the **PPM CAL** menu item.

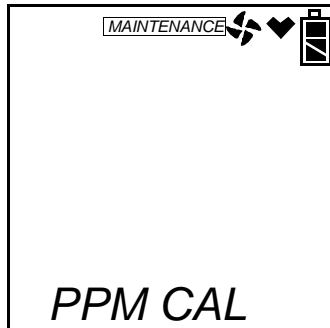

2. Press and release the POWER ENTER button. The display will indicate that the ppm sensor is warming up.

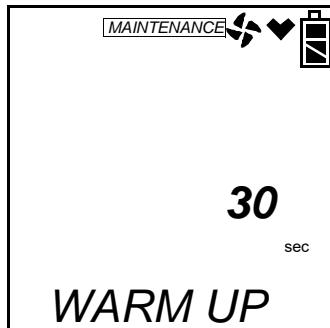

Performing a PPM Fresh Air Adjustment

This section describes how to perform a fresh air adjustment on the PPM combustible gas sensor.

1. Once the warm up is complete, you will be in PPM Cal Mode and AIR CAL will be displayed. You must perform a fresh air adjust before performing an auto calibration, a single calibration, or a bump test.



2. Press and release the POWER ENTER button to enter the AIR CAL menu item. The unit will display the current fresh air reading and prompt you to push the AIR▲ button.

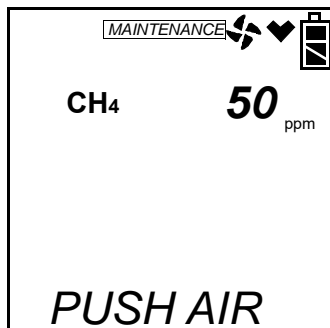

3. Be sure the Gas Tracer is in a fresh air environment.
4. Allow the instrument to draw fresh air for 2 minutes.
5. Hold down the AIR▲ button. The unit will prompt you to continue holding the AIR▲ button.

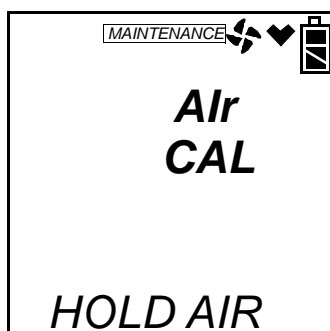

6. When the unit prompts you to release the AIR▲ button, release it. The instrument will perform a fresh air adjustment on the ppm sensor and return you to the AIR CAL menu item.

Performing a PPM Auto Calibration

This section describes how to calibrate the PPM combustible gas sensor using auto calibration.

1. To calibrate the ppm sensor using auto calibration, use the AIR▲ button to scroll to AUTO CAL and press and release the POWER ENTER button.
2. Fill the gas bag with ppm calibration gas as described in “Filling the Gas Bag” on page 191.
3. Attach the hose and probe to the Gas Tracer.

4. Press and release the POWER ENTER button. The calibration value screen will be displayed.

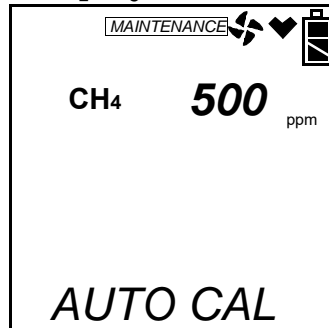

5. The gas concentration displayed in the calibration value screen must match the gas concentration listed on the calibration cylinder. If the concentration matches, go to step 11. If the concentration does not match, continue with step 6.
6. To adjust the value on the screen, hold down the (SHIFT)▼ button, then press the DISPLAY(ADJ) button and release both. The calibration gas value turns into three dashes.

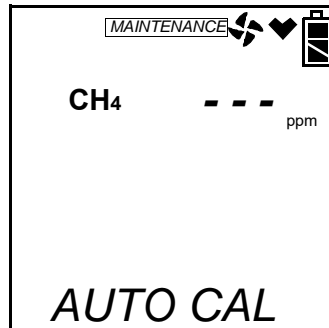

7. Press and release the POWER ENTER button. The sensor's calibration gas value will flash.
8. If necessary, use the AIR▲ and (SHIFT)▼ buttons to set the correct calibration gas value.
9. Press and release the POWER ENTER button to save the change.
10. Use the AIR▲ or (SHIFT)▼ buttons to scroll to ESCAPE and press and release POWER ENTER to return to the calibration gas value screen.

11. With the calibration value screen displayed, press the POWER ENTER button. AUTO CAL begins to flash and the current gas reading is displayed. If you want to exit back to the main menu without completing a calibration, press and release the DISPLAY (ADJ) button.

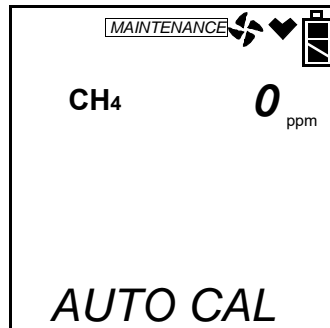

12. Connect the humidifier from the gas bag to the rigid tube on the probe. Allow the gas to flow for two minutes.
13. Press and release the POWER ENTER button to set the calibration to the programmed values.

If the ppm sensor passed calibration, PASS displays along the bottom of the screen, then the AUTO CAL menu item displays.

If the ppm sensor cannot calibrate to the proper value, FAIL displays along the bottom of the screen and the Gas Tracer indicates that the ppm sensor failed to calibrate.

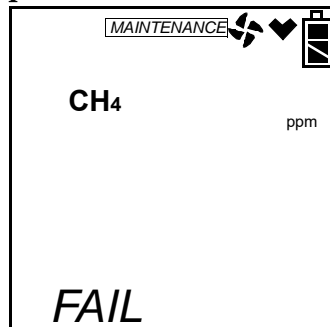

The buzzer and alarm lights activate. Press and release the RESET SILENCE button after the buzzer and lights stop to reset the alarm and return to the AUTO CAL menu item. Attempt to calibrate again. If the failure continues, investigate the cause. See “Troubleshooting” on page 170.

14. Disconnect the humidifier from the probe.

NOTE: Grasp the humidifier tube assembly by the clear tubing at the end, not the humidifier tube itself.

15. Use the (SHIFT)▼ button to navigate to the ESCAPE menu item,

then press and release the POWER ENTER button to return to the **PPM CAL** menu item in Calibration Mode.

16. Use the (SHIFT)▼ button to navigate to the **NORMAL** menu item, then press and release the POWER ENTER button to return to Measuring Mode.

Performing a PPM Single Calibration

This section describes how to calibrate the PPM combustible gas sensor using single calibration.

1. To calibrate the ppm sensor using single calibration, use the AIR▲ button to scroll to ONE CAL and press and release the POWER ENTER button.
2. Fill the gas bag with ppm calibration gas as described in “Filling the Gas Bag” on page 191.
3. Attach the hose and probe to the Gas Tracer.
4. Press and release the POWER ENTER button. The gas reading will be replaced by 3 dashes.

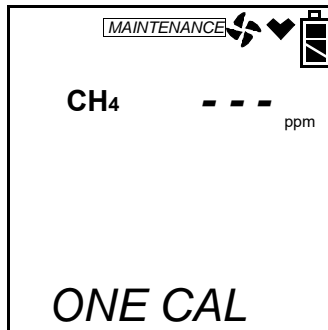

5. Press and release the POWER ENTER button. The single calibration screen displays for the sensor you selected. The gas reading flashes.

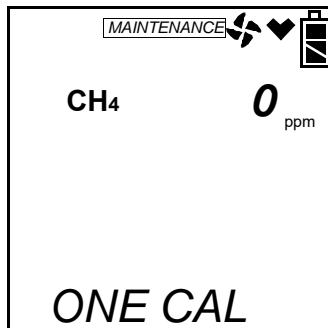

6. Connect the humidifier from the gas bag to the rigid tube on the probe. Allow the calibration gas to flow for two minutes.
7. If necessary, use the AIR▲ and (SHIFT)▼ buttons to adjust the reading to match the concentration listed on the calibration

cylinder.

If the reading already matches the concentration listed on the calibration cylinder, press and release the AIR▲ button then press and release the (SHIFT)▼ button so that the instrument sees a change and resets the calibration date.

8. Press and release the POWER ENTER button to save the span value. The LCD will indicate that the calibration has ended, then the **ONE CAL** menu item displays.
9. Disconnect the humidifier from the probe.

NOTE: Grasp the humidifier tube assembly by the clear tubing at the end, not the humidifier tube itself.

10. Use the (SHIFT)▼ button to navigate to the **ESCAPE** menu item, then press and release the POWER ENTER button to return to the **PPM CAL** menu in Calibration Mode.

11. Use the (SHIFT)▼ button to navigate to the **NORMAL** menu item, then press and release the POWER ENTER button to return to Measuring Mode.

Performing a PPM Bump Test

This section describes how to bump test the PPM combustible gas sensor.

NOTE: The **BUMP DSP** menu item in Maintenance Mode is factory set to OFF. The **BUMP** menu item will not appear unless **BUMP DSP** is set to ON. See “Turning the Bump Test Function On or Off” on page 151 for instructions.

NOTE: The Gas Tracer uses parameters defined in the **BUMP--SET** menu item of Maintenance Mode while performing a bump test. To view or update these parameters, see “Updating the Bump Test Parameters” on page 152.

1. Use the AIR▲ or (SHIFT)▼ buttons to display the BUMP menu item.

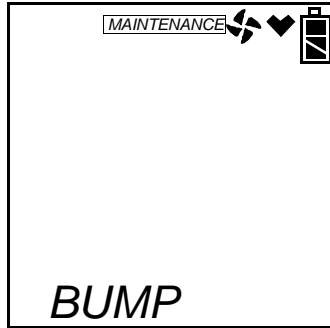

2. Fill the gas bag with ppm calibration gas as described in “Filling the Gas Bag” on page 191.
3. Attach the hose and probe to the Gas Tracer.
4. Press and release the POWER ENTER button. The bump test gas value will be displayed.

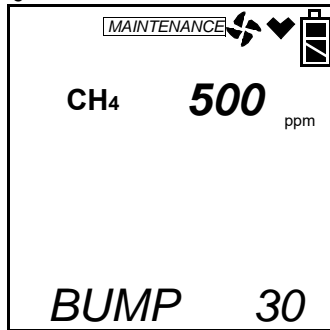

5. Before proceeding, confirm that the bump test gas value is the same as the concentration in the calibration cylinder. If it is not, adjust the bump test gas value by entering the AUTO CAL menu item in the PPM CAL menu, changing the value there, and reentering the BUMP menu.
6. Connect the humidifier from the gas bag to the rigid tube on the probe and quickly press and release the POWER ENTER button. The unit will begin counting down from 30.

7. When AUTO CAL in the **BUMP--SET** menu item in Maintenance Mode is set to OFF:

- The instrument will display if the ppm combustible sensor passed or failed with a P (pass) or an F (fail) to the right of the gas.

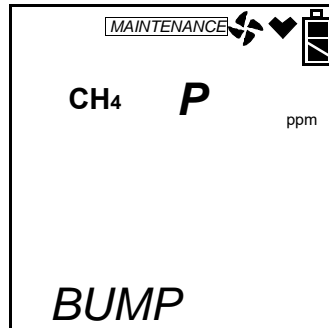

- To view the bump test gas reading press the AIR▲ or (SHIFT)▼ button. You can scroll between the bump test results and the bump test gas reading with the AIR▲ or (SHIFT)▼ buttons.

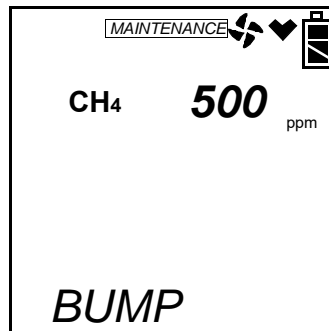

- To return to the BUMP screen in Calibration Mode, press POWER ENTER.

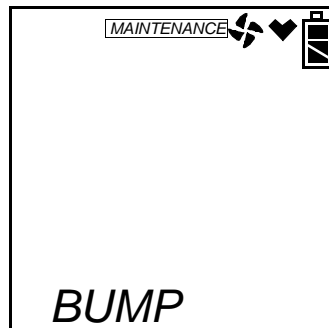

If the sensor fails the bump test, see “Troubleshooting” on page 170 to investigate the cause of the failure and replace the failed sensor if necessary.

- Disconnect the humidifier from the probe.

NOTE: Grasp the humidifier tube assembly by the clear tubing at the end, not the humidifier tube itself.

8. When AUTO CAL in the **BUMP--SET** menu item in Maintenance Mode is set to ON:

If the ppm combustible sensor passes the bump test,

- The following screen appears:

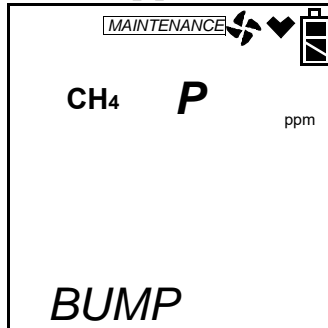

- To view the bump test gas reading press the AIR▲ or (SHIFT)▼ button. You can scroll between the bump test results and the bump test gas reading with the AIR▲ or (SHIFT)▼ buttons.

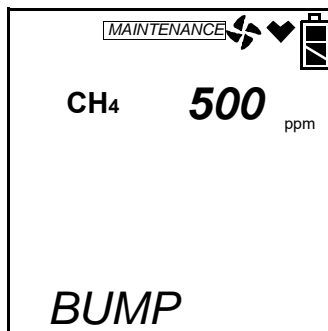

- To return to the BUMP screen in PPM CAL, press POWER ENTER.

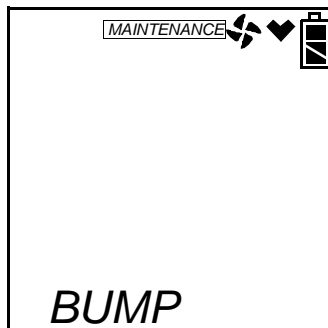

- Disconnect the humidifier from the probe.

NOTE: Grasp the humidifier tube assembly by the clear tubing at the end, not the humidifier tube itself.

If the ppm combustible sensor fails the bump test,

- The instrument will beep and a calibration is immediately and automatically started. Continue to apply the calibration gas. CAL on the bottom left of the screen will alternate with APPLY.

The calibration time will begin to countdown in seconds in the lower right of the screen. The calibration time counted down during a calibration initiated because of a failed bump test is the difference between the bump test gas time and the calibration time defined in the **BUMP--SET** menu item in Maintenance Mode.

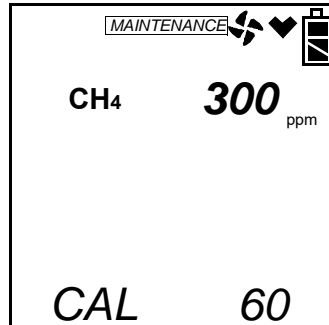

- At the end of the calibration, the instrument displays the results from both the bump test and the calibration. Use the AIR▲ or (SHIFT)▼ button to scroll between the calibration/ bump test results, the bump test gas reading, and the calibration gas reading.

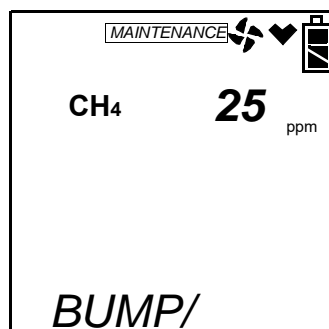
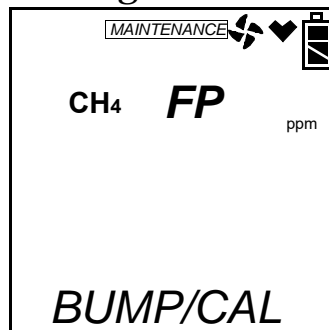

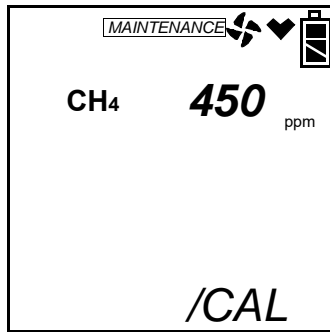

- To return to the BUMP screen in **PPM CAL**, press **POWER ENTER** at any time. If the sensor fails calibration, the buzzer will sound a double pulsing tone until you press and release the **POWER ENTER** button.

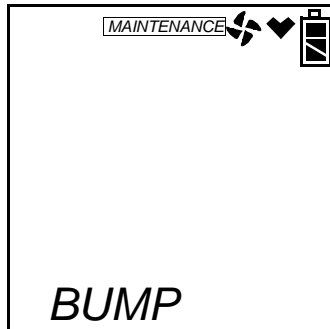

- Disconnect the humidifier from the probe.

NOTE: Grasp the humidifier tube assembly by the clear tubing at the end, not the humidifier tube itself.

9. Use the (SHIFT)▼ button to navigate to the **ESCAPE** menu item, then press and release the **POWER ENTER** button to return to the **PPM CAL** menu item in Calibration Mode.
10. Use the (SHIFT)▼ button to navigate to the **NORMAL** menu item, then press and release the **POWER ENTER** button to return to Measuring Mode.

Parts List

Table 10: Sample Bag Calibration Kit Spare Parts

Part Number	Description
81-0016RK-05	Calibration cylinder, 100% volume methane in nitrogen, 58 liter
81-0018RK-01	Calibration cylinder, 50% isobutane in air, 34 liter
81-0090RK-01	Calibration cylinder, 3-gas mix, LEL/Oxygen/CO, 34 liter
81-1001RK	Dispensing valve, for 17/34 liter cylinders
81-1051RK	Regulator with gauge and knob, 34AL/58 liter/103 liter cylinders,0.5 LPM
81-1126RK	Gas bag with clamp and hose barb, 9" x 9", 2 liter
81-GX03CO-LV	Calibration kit with sample bag, for LEL/Oxy/CO unit, 34 liter steel
81-GX03VCO-LV	Calibration kit with sample bag, for %VOL(CH ₄)/LEL/Oxy/CO unit, 34 liter steel